

Numerical Time Overcurrent Protection and Thermal Overload Relay with Auto-Reclosure Option SIPROTEC 7SJ602 V3.0

Instruction Manual

Order No: C53000-G1176-C125-1



Figure 1 Illustration of the numerical time overcurrent protection relay 7SJ602 (in flush mounting case)

SIEMENS



Indication of Conformity

This product is in conformity with the directive of the Council of the European Communities on the approximation of the laws of the Member States relating to electromagnetic compatibility (EMC Council Directive 89/336/EEC) and concerning electrical equipment for application within specified voltage limits (Low-voltage directive 73/23 EEC).

Conformity is proved by tests that had been performed according to article 10 of the Council Directive in accordance with the generic standards EN 50081–2 and EN 50082–2 (for EMC directive) and the standards EN 60255–6 (for low-voltage directive) by Siemens AG.

The device is designed and manufactured for application in industrial environment.

The device is designed in accordance with the international standards of IEC 255 and the German standards DIN 57435 part 303 (corresponding to VDE 0435 part 303).

Further applicable standards: ANSI/IEEE C37.90, C37.90.1, and C37.90.2.

This product is UL–certified with the values specified in the technical data.

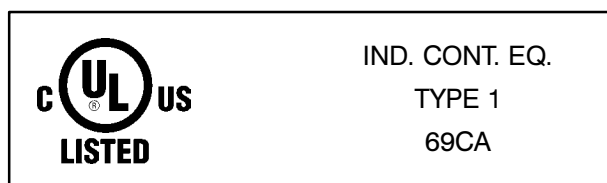

UL–Listed:
Models with screw-type terminals
7SJ602*–***B*****–****
7SJ602*–***E*****–****



UL–Recognized:
Models with plug-in terminals
7SJ602*–***D*****–****

Matching the rated frequency

When the relay is delivered from factory, it is preset to operate with a rated frequency of 50 Hz. If the rated system frequency is 60 Hz, this must be matched accordingly. Switch-over to 60 Hz is explained in detail in the operation instructions in Section 6.3.3, first item. In the following, switch-over to 60 Hz is described in an abbreviated form.

The operating interface is built up by a hierarchically structured menu tree, which can be passed through by means of the scrolling keys \leftarrow , \rightarrow , Δ , and ∇ . Thus, each operation object can be reached as illustrated in the example below for change-over of the rated frequency.

After the relay has been switched on, the green LED ("Service") illuminates and the red LED ("Blocked") lights up until the processor system has started up. The display shows the type identification of the relay

("7SJ602") and the version of the implemented firmware (e.g. "V3.00*").

Pressing the key ∇ leads to the main menu item "PARAM." (parameters). Switch over to the second operation level with key \rightarrow . The first address block is "00 CONF." (configuration). Key ∇ leads to the second address block "01 POWER SYST.DAT" (power system data). On the third operation level, which is obtained with \rightarrow , the first item is "01 FREQ" (frequency).

Press the following keys in sequence: \oplus \ominus \oplus \ominus **E** \oplus . The display shows the new rated frequency 60 Hz. Confirm again with **E** \oplus

Press twice the key \leftarrow to return to the first operation level.

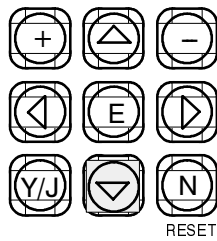

Press ∇ key

press \rightarrow key

press ∇ key

press \rightarrow key

press + key

press - key

press + key

press - key

press **E** key

press **E** key

press + key

press **E** key

rated frequency is now 60 Hz

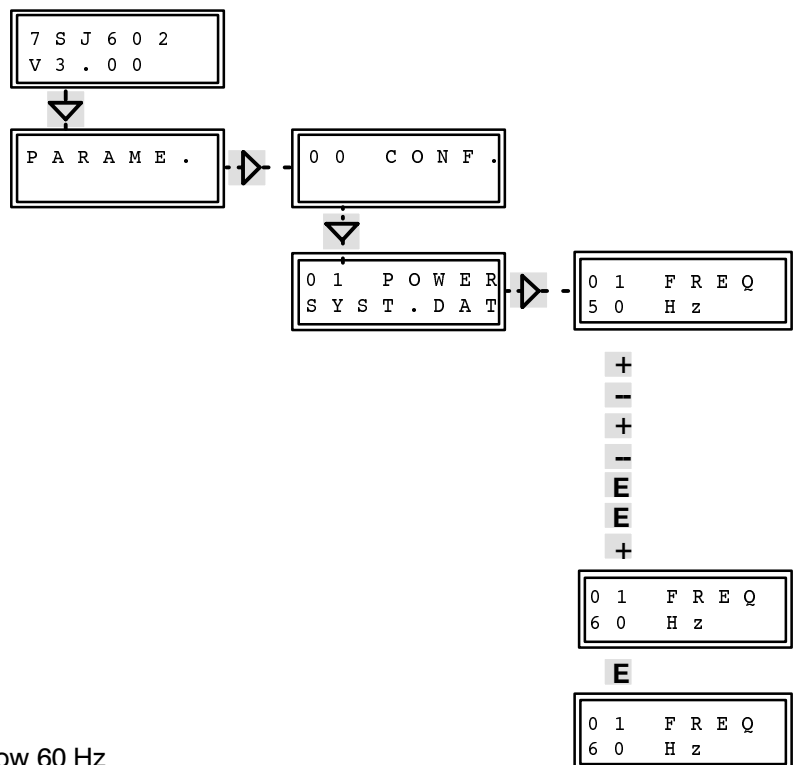

Contents

1	Introduction	8
1.1	Application	8
1.2	Features	8
2	Design	10
2.1	Arrangements	10
2.2	Dimensions	11
2.3	Connections	13
2.3.1	Connections to screwed terminals top and bottom	13
2.3.2	Connections to plug-in terminals on the rear	13
2.3.3	Connections to screwed terminals on the rear	15
2.3.4	Optical fibre interface	17
2.3.5	Electrical interface	17
2.3	Ordering data	18
2.4	Accessories	20
3	Technical Data	21
3.1	General data	21
3.1.1	Inputs/outputs	21
3.1.2	Electrical tests	23
3.1.3	Mechanical stress tests	24
3.1.4	Climatic stress tests	25
3.1.5	Service conditions	25
3.1.6	Design	26
3.2	Definite time overcurrent protection	27
3.3	Inverse time overcurrent protection	28
3.4	Unbalanced load protection	34
3.5	Thermal overload protection	35
3.5.1	Overload protection with memory (total memory according to IEC 60255–8)	35
3.5.2	Overload protection without memory	37
3.6	Start-up time monitoring	38
3.7	Auto-reclosure (optional)	38
3.8	Ancillary functions	40
4	Method of operation	41
4.1	Operation of complete unit	41
4.2	Overcurrent time protection	43
4.2.1	Formation of the measured quantities	43
4.2.2	Definite time overcurrent protection	43
4.2.3	Inverse time overcurrent protection	43
4.2.4	Fast busbar protection using reverse interlocking scheme	47

4.3	Unbalanced load protection	48
4.4	Thermal overload protection	50
4.4.1	Overload protection with total memory	50
4.4.2	Overload protection without memory	51
4.5	Start-up time monitoring	52
4.6	Automatic reclosure (optional)	53
4.7	Trip circuit supervision	54
4.7.1	Supervision using two binary inputs	54
4.7.2	Supervision using one binary input	54
4.8	Ancillary functions	58
4.8.1	Processing of annunciations	58
4.8.1.1	Indicators and binary outputs (signal relays)	58
4.8.1.2	Information on the display panel or to a personal computer	58
4.8.2	Data storage and transmission for fault recording	59
4.8.3	Operating measurements and conversion	59
4.8.4	Control functions	60
4.8.5	Test facilities	61
4.8.5.1	Circuit breaker trip test	61
4.8.5.2	Interrogation of binary states	61
4.8.5	Monitoring functions	61
4.8.5.1	Hardware monitoring	61
4.8.5.2	Software monitoring	62
4.8.5.3	Measured value supervision	62
5	Installation instructions	63
5.1	Unpacking and repacking	63
5.2	Preparations	63
5.2.1	Mounting and connections	64
5.2.1.1	Model 7SJ602★-★B★★ for panel surface mounting	64
5.2.1.2	Model 7SJ602★-★D★★ or -★E★★ for panel flush mounting or cubicle installation	64
5.2.2	Checking the rated data	64
5.2.2.1	Auxiliary voltage	64
5.2.2.2	Rated currents	65
5.2.2.3	Control d.c. voltage of binary inputs	65
5.2.2.4	Contact mode of the “Life–status” contact	65
5.2.2.5	Performing alterations of the jumpers	65
5.2.3	Connections	67
5.2.4	Checking the connections	68
5.3	Configuration of operation and memory functions	69
5.3.1	Operational preconditions and general	69
5.3.2	Settings for the integrated operation – address block 71	71
5.3.3	Configuration of the serial interfaces – address block 72	72
5.3.4	Settings for fault recording – address block 74	75
5.4	Configuration of the protective functions	76
5.4.1	Introduction	76
5.4.2	Programming the scope of functions – address block 00	77
5.5	Marshalling of binary inputs, binary outputs and LED indicators	79
5.5.1	Introduction	79
5.5.2	Marshalling of the binary inputs – address block 61	81
5.5.3	Marshalling of the output relays – address block 64	84
5.5.4	Marshalling of the LED indicators – address block 63	88
5.5.5	Marshalling of auto-reclosure conditions – address block 65	89

6	Operating instructions	91
6.1	Safety precautions	91
6.2	Dialog with the relay	91
6.2.1	Membrane keyboard and display panel	91
6.2.2	Operation with a personal computer	92
6.2.3	Operational preconditions	92
6.2.4	Representation of the relay (front view)	93
6.3	Setting the functional parameters	94
6.3.1	Introduction	94
6.3.1.1	Parameterizing procedure	94
6.3.1.2	Setting of date and time	96
6.3.2	Initial display	97
6.3.3	Power system data – address block 01	97
6.3.4	Settings for phase fault overcurrent time protection – address block 10	99
6.3.5	Settings for earth fault overcurrent time protection – address block 11	104
6.3.6	Settings for unbalanced load protection – address block 24	108
6.3.7	Settings for thermal overload protection – address block 27	109
6.3.7.1	Overload protection with total memory	109
6.3.7.2	Overload protection without memory	111
6.3.8	Settings for start-up time monitoring – address block 28	112
6.3.9	Settings for measured value supervision – address block 29	113
6.3.10	Settings for auto-reclosure – address block 34	114
6.3.11	Settings for circuit breaker control – address block 37	116
6.3.12	Settings for user definable logical functions – address block 38	117
6.3.13	Settings for trip circuit supervision – address block 39	118
6.4	Annunciations	119
6.4.1	Introduction	119
6.4.2	Operational annunciations – address block 81	121
6.4.3	Fault annunciations – address block 82	126
6.4.4	Read-out of operational measured values – address block 84	130
6.5	Operational control facilities	132
6.5.1	Adjusting and synchronizing the real time clock	132
6.5.2	Circuit breaker control	134
6.6	Testing and commissioning	135
6.6.1	General	135
6.6.2	Testing the high-set overcurrent protection stages $I_{>>}$, $I_{E>>}$, and the instantaneous stage $I_{>>>}$	136
6.6.3	Testing the definite time overcurrent protection stages $I_{>}$, $I_{E>}$	136
6.6.4	Testing the inverse time overcurrent protection stages I_p , I_{Ep}	137
6.6.5	Testing the unbalanced load protection	138
6.6.6	Testing the overload protection	138
6.6.6.1	Overload protection without memory	138
6.6.6.2	Overload protection with total memory	139
6.6.7	Testing the start-up time monitor	139
6.6.8	Testing the auto-reclose functions (if fitted)	140
6.6.9	Testing the trip circuit supervision	140
6.6.9.1	Trip circuit supervision with two binary inputs	140
6.6.9.2	Trip circuit supervision with one binary input	140

6.7	Commissioning using primary tests	141
6.7.1	Current circuit checks	141
6.7.2	Checking the reverse interlock scheme (if used)	141
6.7.3	Testing the use definable logical functions	142
6.7.4	Testing the switching conditions of binary inputs and outputs	142
6.7.5	Testing the control commands	144
6.7.6	Tripping test including circuit breaker	145
6.7.6.1	TRIP–CLOSE test cycle	145
6.7.6.2	Live tripping of the circuit breaker	146
6.8	Putting the relay into operation	147
7	Maintenance and fault tracing	148
7.1	Routine checks	148
7.2	Fault tracing	148
7.2.1	Replacing the mini-fuse	149
8	Repairs	150
9	Storage	150
Appendix		151
A	General diagram	152
B	Current transformer circuits	153
C	Operation structure, Tables	155

NOTE:

This instruction manual does not purport to cover all details in equipment, nor to provide for every possible contingency to be met in connection with installation, operation or maintenance.

Should further information be desired or should particular problems arise which are not covered sufficiently for the purchaser's purpose, the matter should be referred to the local Siemens sales office.

The contents of this instruction manual shall not become part nor modify any prior or existing agreement, commitment or relationship. The sales contract contains the entire obligations of Siemens. The warranty contained in the contract between the parties is the sole warranty of Siemens. Any statements contained herein do not create new warranties nor modify the existing warranty.

1 Introduction

1.1 Application

The relay SIPROTEC 7SJ602 is used as definite time overcurrent protection or inverse time overcurrent protection for overhead lines, cables, transformers, and motors in high voltage distribution systems with infeed from one single end or radial feeders or open ring feeders. It is also used as back-up protection for comparison protection such as line, transformer, generator, motor, and busbar protection. The treatment of the system star point is of no concern.

Besides the time overcurrent protection, 7SJ602 includes a thermal overload protection and an unbalanced load protection as well as a start-up time monitor for motors. Thus, for example, cables can be protected against overloading and motors can be protected against overloading, excessive start-up time and negative sequence currents.

For use on overhead lines, a model with integrated auto-reclosure function is available which allows up to nine auto-reclosure attempts.

Throughout a fault in the network the magnitudes of the instantaneous values are stored for a period of max. 5 seconds and are available for subsequent fault analysis. In order to achieve this, the relay may be equipped with a serial interface. There are optional models with a SIPROTEC–communication module for RS232, RS485, or optical fibre connections. Thus, comfortable and clear evaluation of the fault history including fault recording is possible as well as comfortable operation of the relay, by means of a personal computer with appropriate programs. This interface is suited to communication via a modem link.

Continuous monitoring of the hardware and software of the relay permits rapid annunciation of internal faults. This ensures the high reliability and availability of the device.

1.2 Features

- Processor system with powerful 16-bit-microcontroller;
- complete digital measured value processing and control from data acquisition and digitizing of the measured values up to the trip and close decisions for the circuit breaker;
- complete galvanic and reliable separation of the internal processing circuits from the measurement, control and supply circuits of the system, with analog input transducers, binary input and output modules, and d.c./d.c. converter;
- phase segregated overcurrent detection;
- separate overcurrent detection in the residual (earth) path;
- insensitive against d.c. components, inrush or charging currents and high frequency transients in the measured currents;
- selectable tripping time characteristics: either definite time lag or inverse time lag with a large number of characteristics according to IEC or ANSI/IEEE;
- each characteristic with an independent instantaneous or definite time lag I>> stage; additional instantaneous very high current stage I>>> for phase currents;
- dynamic switch-over of sets of current thresholds even during fault, via binary inputs;
- thermal overload protection, optionally without or with total memory (thermal replica of the current heat losses);
- start-up time monitor for use on motors (locked rotor monitor);

- unbalanced load protection for detection of phase failure, wrong phase rotation, and impermissible unsymmetrical load;
- three-pole auto-reclosure function, single- or multi-shot (up to nine auto-reclosure attempts), with separately allocated timers for the first four shots;
- circuit breaker operation test facility by test trip–close cycle (models with auto-reclosure) or test trip of the breaker;
- circuit breaker control;
- trip circuit supervision for the tripping coil including the circuitry;
- simple setting and operation using the integrated operation panel or a connected personal computer with menu-guided software;
- storage of fault data, storage of instantaneous values during a fault for fault recording;
- continuous monitoring of the hardware and software of the relay as well as supervision of the sum of the four current inputs;
- optional serial interface with a communication module: RS232, RS485, or optical fibre.

2 Design

2.1 Arrangements

All protection functions including dc/dc converter are accommodated on a printed circuit board of Double Europa Format. This p.c.b. forms, complemented by a guide plate, a multi-pin terminal module and a front unit, a plug-in module which is installed in a housing 7XP20. The guide plate cams in conjunction with distance pieces on the p.c.b. and the shaping of the terminal modules ensure proper mounting and fixing of the module. The inner part of the housing is free from enamel and thus functions as a large contact plane and shield with solid electrical conductivity and mates with the earthing blades of the module. Connection to earth is made before the plugs make contact. An earthing area has been provided at the housing to which grounding strips can be connected in order to ensure solid low-impedance earthing.

At the bottom of the housing, an optional communication module may be arranged. This module is fixed with two screws at the housing.

The heavy duty current terminals provide automatic shorting of the c.t. circuits whenever the module is withdrawn. This does not release from the care to be taken when c.t. secondary circuits are concerned.

The degree of protection for the housing is IP51, for the terminals IP21.

Three different types of housings can be delivered:

- **7SJ602★–★B★★**– in housing 7XP20 with **screwed terminals top and bottom**, for **panel surface mounting**

The housing is built of a metal tube and a rear wall and carries a terminal block with four holes for fixing the relay to the panel.

With the exception of the optional communication port, all external signals are connected to screwed terminals which are arranged over cut-

outs on the top and bottom covers. The terminals are numbered consecutively from left to right at the bottom and top. Use copper conductors only!

For dimensions please refer to Figure 2.1.

- **7SJ602★–★D★★**– in housing 7XP20 with **plug-in terminals at the rear**, for **panel flush mounting** or **cubicle installation**

The housing is built of a metal tube and a rear wall and carries mounting angles for mounting into the panel cut-out or into the cubicle rack.

With the exception of the optional communication port, all external signals are connected to terminal blocks which are mounted without screws at the rear of the housing. For each electrical connection, one plug-in terminal is provided. Plug-in terminals are available only for voltage connections. For current connection, screwed terminals are always installed (see below). Use copper conductors only!

For dimensions please refer to Figure 2.2.

- **7SJ602★–★E★★**– in housing 7XP20 with **screwed terminals at the rear**, for **panel flush mounting** or **cubicle installation**

The housing is built of a metal tube and a rear wall and carries mounting angles for mounting into the panel cut-out or into the cubicle rack.

With the exception of the optional communication port, all external signals are connected to terminal blocks which are mounted without screws at the rear of the housing. For each electrical connection, one screwed terminal for the use of up to two ring cable lugs and one parallel snap-in terminal are provided. Use copper conductors only!

For dimensions please refer to Figure 2.2.

2.2 Dimensions

Figures 2.1 to 2.2 show the dimensions of the various types of housings available.

7SJ602★-★B★★ in housing for **panel surface mounting** 7XP20 with terminals top and bottom

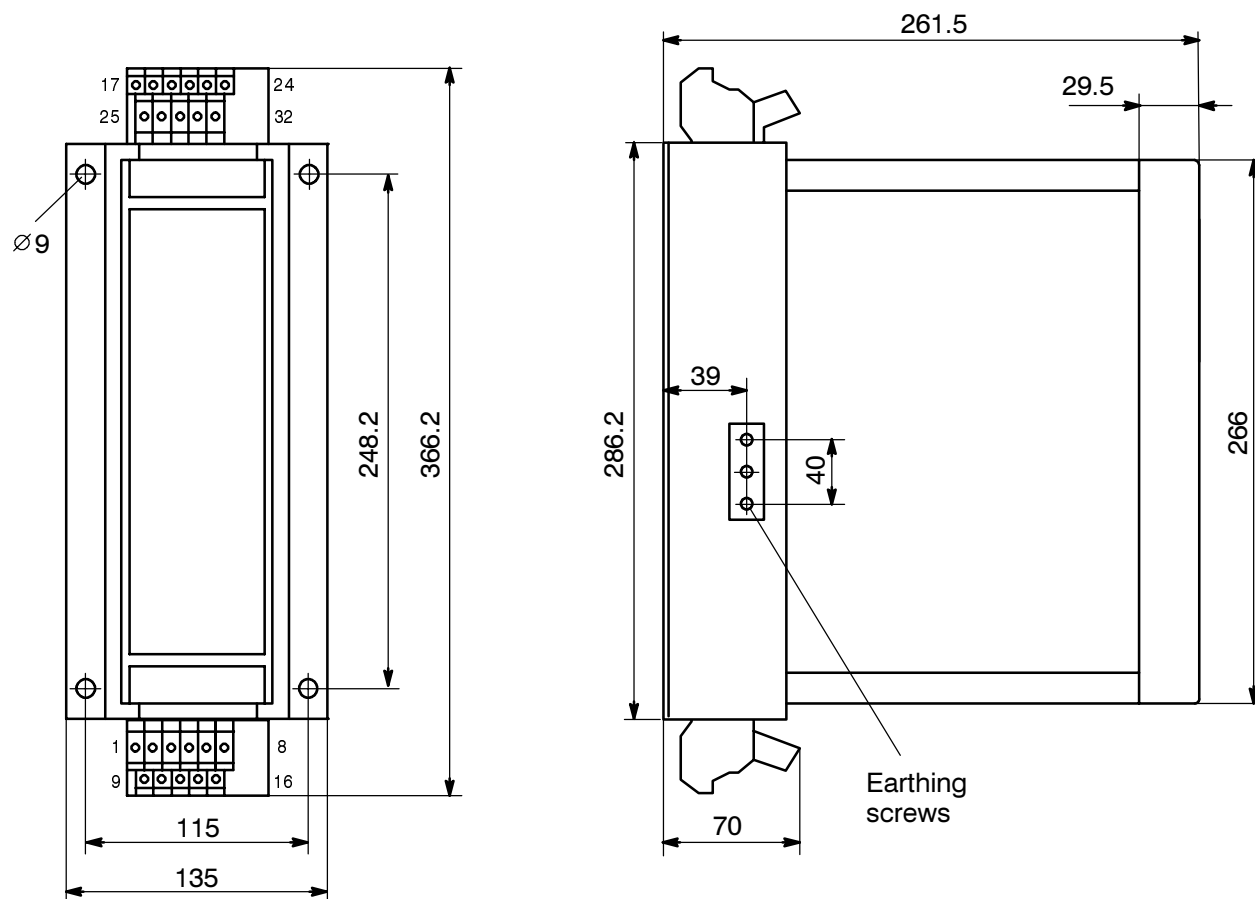

Installation on the panel shall be carried out with studs or screws size M6.

If the relay is to be mounted on (e.g. existing) bolts size M8, then slot nuts acc. DIN 546 shall be used.

Dimensions in mm

Figure 2.1 Dimensions for housing 7XP20 for panel surface mounting with terminals top and bottom

7SJ602*-★D/E*** Housing for panel flush mounting or cubicle installation 7XP20

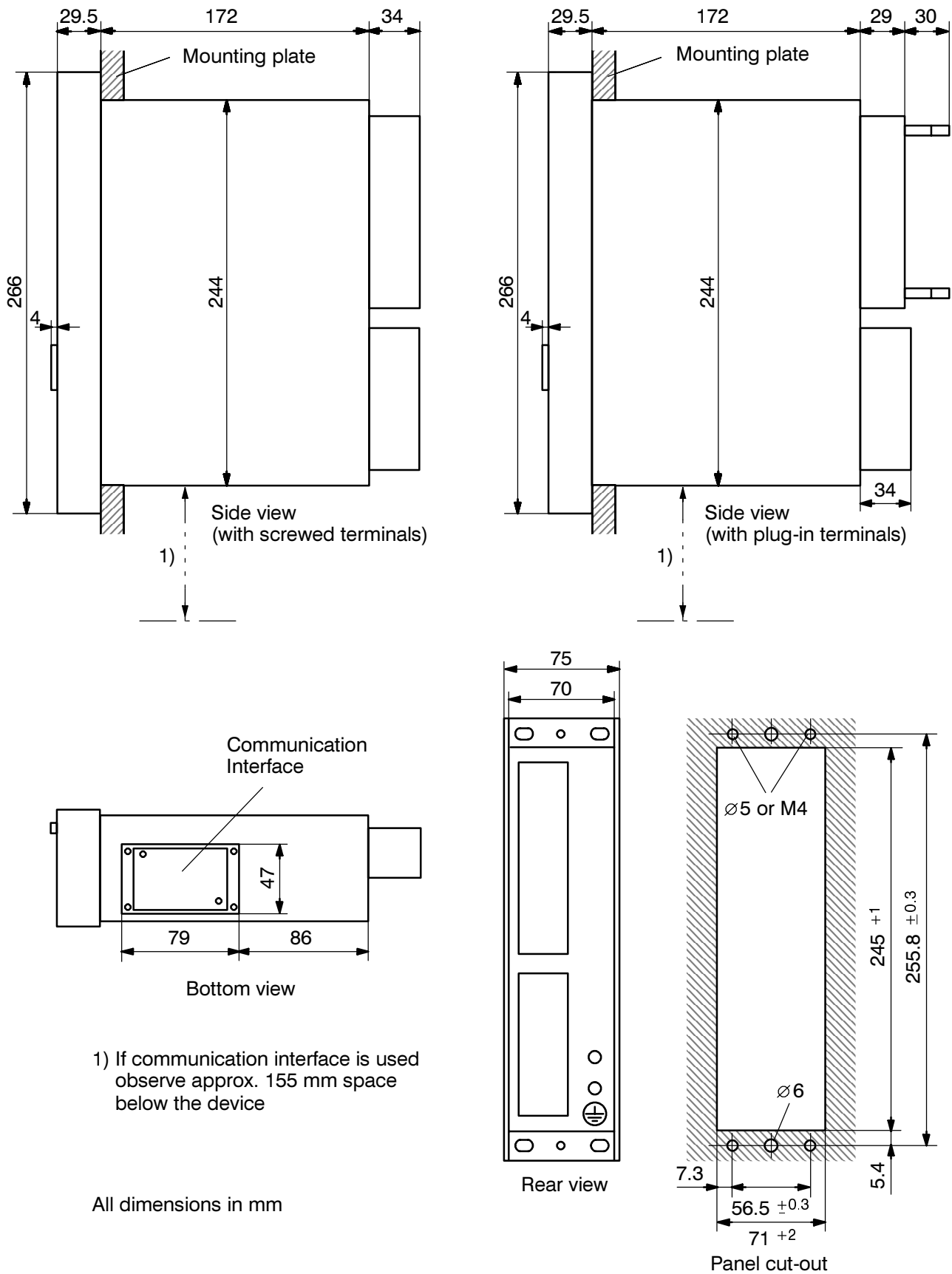

Figure 2.2 Dimensions for housing 7XP20 for panel flush mounting or cubicle installation

2.3 Connections

2.3.1 Connections to screwed terminals top and bottom

All external signals are connected to screwed terminals which are arranged over cut-outs on the top and bottom covers. The terminals are numbered consecutively from left to right at the bottom and top.

The heavy duty current plug terminals provide automatic shorting of the c.t. circuits whenever the module is withdrawn. This does not release from the care to be taken when c.t. secondary circuits are concerned.

The following data must be observed:

Direct connection with solid bare wire or flexible wire with end sleeves;
for cross-section 0.5 mm² to 5,0 mm²: AWG 20 to AWG 10.

Use copper conductors only!

Max torque value: 1.2 Nm or 10.6 in-lb.

2.3.2 Connections to plug-in terminals on the rear

Plug-in terminals are only available for voltage connections. Current connections are always made with screw terminals on all devices. See Section 2.3.3.

There are two versions of plug-in terminal blocks. They are illustrated in Figure 2.3.

The system of numbers and letters used to designate the plug-in terminals is shown in Figure 2.4.

Each plug-in terminal forms a complete set of connections that consists of three pins arranged as follows:

- Pin a: Signal contact
- Pin b: Group contact
- Pin c: Screen contact

The signal contacts are the only terminal pins that are directly connected to the internal printed circuit boards of the device. Depending on the version of the terminal block, 18 or 12 signal contacts are provided. Refer to Figure 2.5.

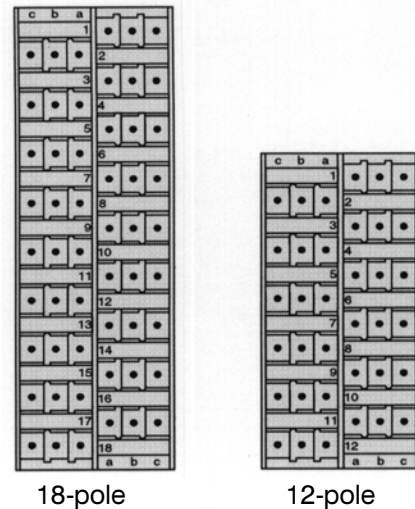

Figure 2.3 Connection modules for plug-in terminals

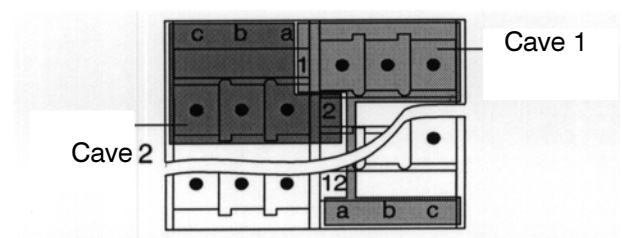

Figure 2.4 Correlation between plug-in terminals and connection numbers/letters

There are two isolated groups of common pins. Within a group the pins are interconnected as shown in Figure 2.5. The common pins "b" are not connected to the boards inside the device. Each common group can, for example, be used for signal multiplication or as a common point for a signal (independent of the signals on the pin "a" terminals). Depending on the version of the terminal block, 18 or 12 group contacts are available.

Grouping of group contacts within a terminal block is as follows:

12-pole block:

- Group 1 Terminals 1 through 6
- Group 2 Terminals 7 through 12

18-pole block:

- Group 1 Terminals 1 through 9
- Group 2 Terminals 10 through 18

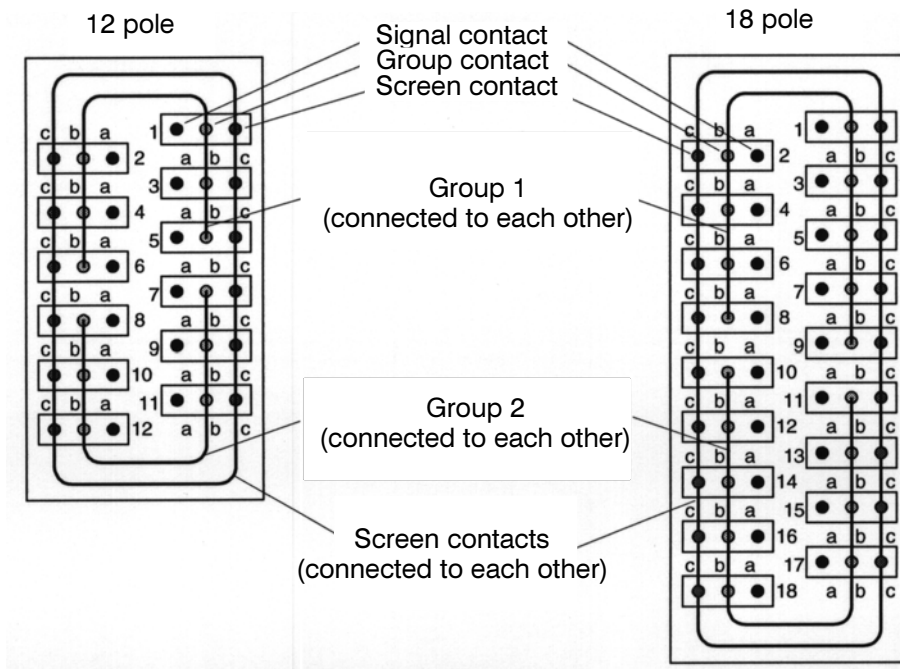

Figure 2.5 Scheme of the contact set

All screen pins are connected together as shown in Figure 2.5. The screen pins are also connected to the housing. Depending on the version of the pole block, 18 or 12 screen contacts are provided.

Figure 2.5 show a scheme of the arrangement of the three contact modes.

Two- and three-pole boxes are available for connection of the pin terminals (Figure 2.6).

Ordering information for the pin terminals is provided in Section 2.5 Accessories.

The design of the pin terminals is such that only correct connections can be made. For example, the design of the 2-pin terminal allows connection only to pins “a” and “b”. An erroneous connection to pins “b” and “c” is excluded.

The pin terminal boxes snap into the plug-in terminals. The boxes can be removed without tools.

The wires are crimped to the crimp terminals which are inserted into the terminal boxes. Only flexible copper wires must be used!

The following data must be observed:

Wires with 0.5 mm² to 2.5 mm² diameter (AWG 20 to 13). Use only flexible copper control wire!

Crimp terminals:

For cross-section 0.5 mm² to 1.0 mm²:
e.g. Bandware 4000 pieces
type: 827039–1 from Messrs AMP

Individual piece
type: 827396–1 from Messrs AMP

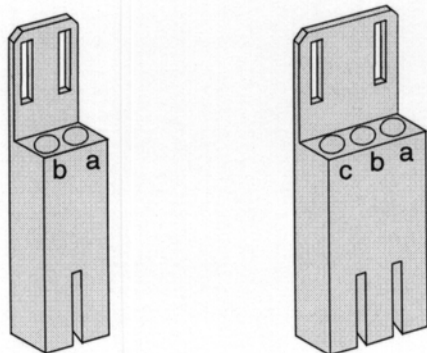

Figure 2.6 2-pin and 3-pin terminal box

For cross-section 1.0 mm² to 2.5 mm²:
e.g. Bandware 4000 pieces
type: 827040–1 from Messrs AMP

Individual piece
type: 827397–1 from Messrs AMP

Connection of a conductor to a contact is performed using a hand crimping tool,
e.g. type: 0–825582–0 from Messrs AMP.

After the wires are crimped, the contacts are pressed into the terminal box until they snap into place.

Stress relief for the individual terminal box must be provided with cable ties. Stress relief must also be provided for the entire set of cables, e.g. cable ties.

The following separation tool is needed to remove the contacts from the terminal box:
Type: 725840–1 from Messrs AMP.

The separation tool contains a small tube that is subject to wear. The tube can be ordered separately:
Type: 725841–0 from Messrs AMP.

2.3.3 Connections to screwed terminal on the rear

The following must be distinguished in the case of connection via screw terminals:
terminal plugs for voltage connections and
terminal plugs for current connections.

The terminal screws have a slot head for tightening or loosening with a flat screw driver, sized 6 x 1.

Voltage terminals

The voltage connection terminal modules are available in 2 variants (Figure 2.7).

Ring-type and fork-type lugs may be used. To ensure that the insulation paths are maintained, insulated lugs must be used. Alternatively, the crimping area must be insulated with other methods, e.g. by covering with a shrink sleeve.

The following data must be observed:

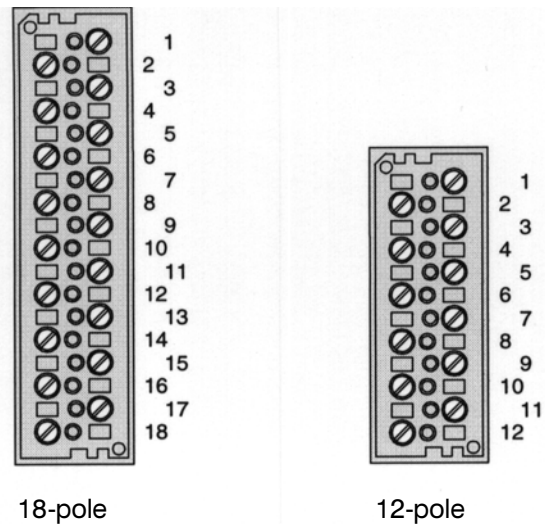

Figure 2.7 Connection modules for screwed terminals (voltage) – rear view

Cable lugs: for bolt diameter 4 mm;
max. major diameter 10 mm;
for cross-section 1.0 mm² to 2.6 mm²; AWG 17 to AWG 13.

Use copper conductors only!

Recommended cable lugs series PIDG of Messrs. AMP, e.g.

ring-type cable lug	type PIDG PN 320 565–0,
fork-type cable lug	type PIDG PN 321 233–0.

Direct connection

with solid bare wire or flexible wire with end sleeves
for cross-section 0.5 mm² to 3.3 mm²; AWG 20 to AWG 12.

Use copper conductors only!

Max torque value: 1.8 Nm or 16 in-lb.

Current terminals

Current terminals are provided with 8 terminals. The available terminals are arranged into terminal pairs, each containing two poles. In this manner, two neighboring terminals form one pair. Accordingly, the current terminal module with 8 poles contains four pairs.

In combination with the plug connections on the device side, these terminal pairs have an integrated short-circuit function which shorts the two neighboring current passages when the module is withdrawn.

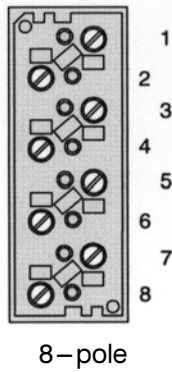

Figure 2.8 Terminal block of screw terminals for current connections – rear view

When the module is inserted, the current path has a low impedance termination via the measuring inputs on the module. During insertion of the module, the short-circuit of the current path is automatically removed. The interruption of the short-circuit only occurs once a reliable contact to the plug terminal on the module is established. This does not reduce the care that must be taken when working on the current transformer secondary circuits!

Ring-type and fork-type lugs may be used. To ensure that the insulation paths are maintained, insulated lugs must be used. Alternatively, the crimping area must be insulated with other methods, e.g. by covering with a shrink sleeve.

The following data must be observed:

Cable lugs: for bolt diameter 5 mm; max. major diameter 12 mm; cross-section 2.7 mm² to 6.6 mm²; AWG 13 to AWG 9. Use copper conductors only!

Recommended cable lugs series PIDG of Messrs. AMP, e.g.
 ring-type cable lug type PIDG PN 130 171–0,
 fork-type cable lug type PIDG PN 326 865–0.

Direct connection
 with solid bare wire or flexible wire with end sleeves cross-section 2 mm² to 5 mm²; AWG 14 to AWG 10. Use copper conductors only!

Max torque value: 2.7 Nm or 24 in-lb.

Short-Circuit Links

Short-circuit links are available for convenience in making terminal connections. The short circuit links can connect two neighboring terminals located on the same side of the terminal module. By connecting further links, neighboring terminals can be included in the short circuit. On each terminal it is possible to connect two short-circuiting links, or one short-circuit link and one lug, or one individual conductor.

The links meet the safety requirements for protection against electronic shock.

There are two types of links, one for voltage connections and one for current connections. The links are illustrated in Figure 2.9. Ordering information for the links is provided in Section 2.5 Accessories.

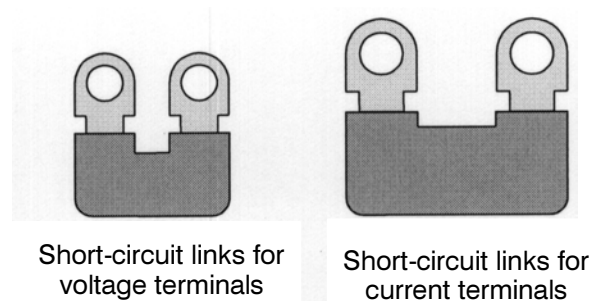

Figure 2.9 Short-circuit links for voltage and current connections

Cover cap

Terminal cover caps are available for the screw terminal modules, to increase the protection of personnel against hazardous voltages (degree of protection against access to dangerous parts) on the terminal modules. The degree of protection is increased from the standard “back of the hand protection (IP1x)” to “finger protection (IP2x)”.

The terminal cover caps provide an enclosure which securely covers all voltage carrying components. They are simply snapped onto the terminal module. It must be noted that all screws on the terminal module must be screws in before snapping the cover on. The terminal covering cap can simply be removed with a screw driver 6 x 1.

There are two types of cover caps, as shown in Figure 2.10. Ordering information is provided in Section 2.5 Accessories.

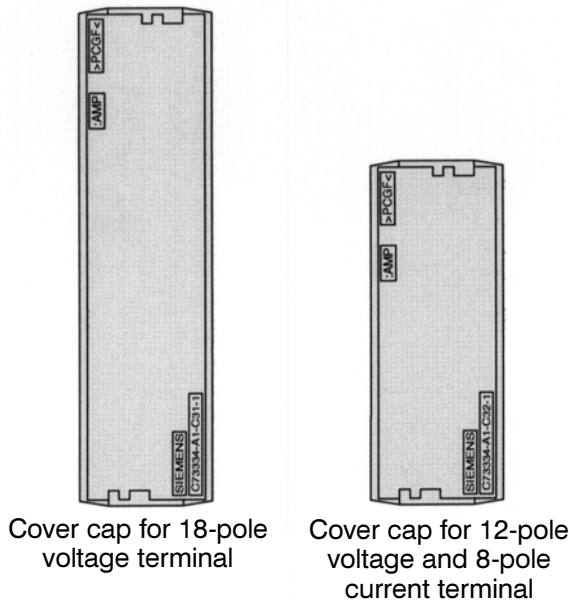

Figure 2.10 Cover caps for terminal blocks

2.3.4 Optical fibre interface

The three available versions of optical communication interfaces are shown in Figure 2.11. The ports are supplied with caps to protect the optical components against dust or other contaminants. The caps can be removed by turning them 90° to the left.

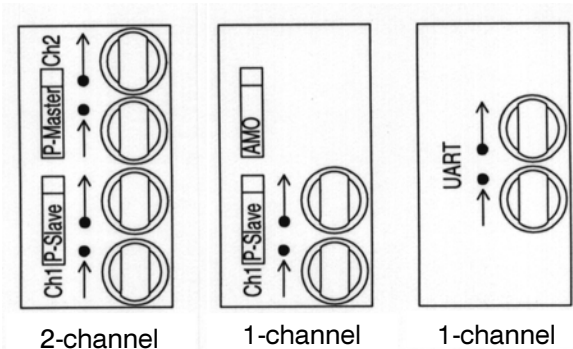

Figure 2.11 Optical interfaces with protective caps

Optical connector type: ST-terminal
 fibre type:

Multimode graded-index ("G") optical fibre
 G50/125 μm, G62,5/125 μm, G100/140 μm
 Optical wavelength: λ ca. 820 nm (a)

Allowable bending radius:

for indoor cables $r_{min} = 5 \text{ cm}$ (2 in)

for outdoor cables $r_{min} = 20 \text{ cm}$ (8 in)

Laser class 1 (acc. EN 60825-1) is achieved with fibre type G50/125 μm and G62,5/125 μm

2.3.5 Electrical interface

9-pin D-subminiature female socket terminals are provided for all electrical communication interfaces (Figure 2.12).

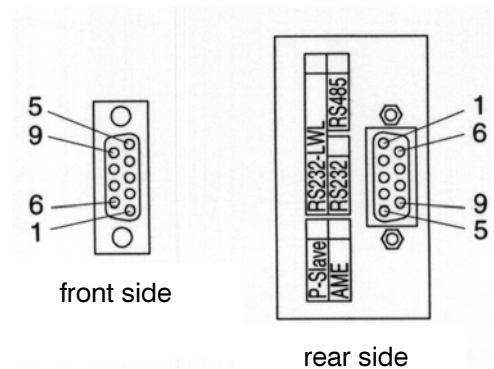

Figure 2.12 9-pin D-subminiature terminal

Standard 9-pin D-subminiature plug terminals per MIL-C-24 308 and DIN 41 652 can be used.

The necessary communication cables are depend on the type of interface:

- RS 232/EIA232: five-wire, twisted and shielded, e.g. interface cable 7XV5100-4.
- RS 485/EIA: three-wire, twisted and shielded.

2.4 Ordering data

Numerical Time Overcurrent Protection		7.	8.	9.	10.	11.	12.	13.	14.	15.	16.	
7 S J 6 0 2		<input type="text"/>	-	<input type="text"/>	<input type="text"/>	B	0	-	<input type="text"/>	<input type="text"/>	<input type="text"/>	<input type="text"/>
Rated current; rated frequency		↑	↑	↑	↑	↑	↑	↑	↑	↑	↑	↑
1 A; 50/60 Hz		1										
5 A; 50/60 Hz		5										
Auxiliary voltage		.										
24/48 V dc			2									
48/60/110/125 V dc			4									
110/220/250 V dc / 115 V ac, 50/60 Hz			5									
230 V ac, 50/60 Hz			6									
Construction												
in housing for panel surface mounting with screw-type terminals top and bottom							B					
in housing for panel flush mounting with plug terminals at the rear							D					
in housing for panel flush mounting/cubicle with screw-type terminals at the rear							E					
System interface												
without							0					
RS232; protocol acc. IEC 870-5-103							1					
RS485; protocol acc. IEC 870-5-103							2					
optical fibre; protocol acc. IEC 870-5-103							3					

(next page)

Numerical Overcurrent Time Protection

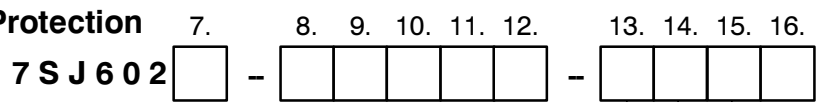

Options 1

without fault recording	0
with fault recording	1

Options 2

without	B	A
with thermal overload protection, trip circuit supervision, dynamic parameter change-over, unbalanced load protection	F	A
with thermal overload protection, trip circuit supervision, dynamic parameter change-over, unbalanced load protection, and start-up time monitor for motors	H	A

Options 3

without auto-reclosure	0
with auto-reclosure	1

2.5 Accessories

The copper connecting cable 7XV5100 is to connect the 25-pole terminal at the converter which is designated with "RS232", with the personal computer or laptop.

Connection accessories are available for housings with plug-in terminals. For installation in 19"-racks, mounting rails are necessary to accommodate the relay case.

Copper connecting cable

between PC (9pin socket) and converter/protective device

7XV5100-4

Operating software DIGSI 4:

The 7SJ602 protection relay is operated by 7SJ602 DIGSI 3, which is integrated into DIGSI 4.

Basic

Full version with license for 10 computers, on DIGSI 4 CD-ROM
(authorization with license number)

Additional: DIGSI 3 CD-ROM

7XS5400-0AA00

Professional

Complete version: Basic and all optional packages, full version
with license for 10 computers on DIGSI 4 CD-ROM

Additional: DIGSI 3 CD-ROM

7XS5402-0AA00

Basic Upgrade 3 → 4

(Basic, DIGRA, Graphic Tools)

Full version with license for 10 computers on DIGSI 4 CD-ROM
(authorization with license number, service agreement
for version 3 expires automatically)

Additional: DIGSI 3 CD-ROM

7XS5405-0AA00

Professional Upgrade 3 → 4

Complete version: Basic and all optional packages,
full version with license for 10 computers on DIGSI 4 CD-ROM

(authorization with license number, service agreement
for version 3 expires automatically)

Additional: DIGSI 3 CD-ROM

7XS5406-0AA00

Installation accessories:

Covering cap for plug-in terminal blocks

18 terminal voltage

C73334-A1-C31-1

8 terminal current block

C73334-A1-C32-1

Short circuit links for plug-in terminal blocks

18 terminal voltage

C73334-A1-C34-1

8 terminal current block

C73334-A1-C33-1

socket housing for plug-in terminal blocks

for 2-pin terminal

C73334-A1-C35-1

for 3-pin terminal

C73334-A1-C36-1

Mounting rail

for installation in 19"-rack

C73165-A63-C200-2

3 Technical data

3.1 General data

3.1.1 Inputs/outputs

Measuring circuits

Rated current I_N	1 A or 5 A
Rated frequency f_N	50 Hz/60 Hz (selectable)
Power consumption	current path at $I_N = 1$ A <0.1 VA current path at $I_N = 5$ A <0.3 VA
Overload capability	current path
– thermal (rms)	100 $\times I_N$ for ≤ 1 s 30 $\times I_N$ for ≤ 10 s 4 $\times I_N$ continuous
– dynamic (pulse current)	250 $\times I_N$ one half cycle

Auxiliary voltage

Power supply via integrated dc/dc converter

Rated auxiliary voltage U_H dc	24/48 Vdc	48/60/110/125 Vdc	110/220/250 Vdc
Permissible variations	19 to 58 Vdc	38 to 150 Vdc	176 to 300 Vdc
Superimposed ac voltage, peak-to-peak	$\leq 12\%$ at rated voltage $\leq 6\%$ at limits of admissible voltage		
Power consumption	approx. 3 W to 6 W dependent on operating condition and aux. voltage		
Bridging time during failure/short-circuit of auxiliary voltage	≥ 50 ms		
Rated auxiliary voltage U_H ac	115 Vac, 50/60 Hz	230 Vac, 50/60 Hz	
Permissible variations	92 to 133 Vac	184 to 265 Vac	
Power consumption	approx. 3 VA to 6 VA dependent on operating condition and aux. voltage		

Output relays

Command/signalling relays	4 (can be marshalled) with 1 NO contact each
Life status/alarm relay	1 with 1 NO or 1 NC contact (reconnectable)
Switching capacity	MAKE 1000 W/VA BREAK 30 VA 40 W resistive 25 W at $L/R \leq 50$ ms

Switching voltage		250 V
Permissible current per contact		5 A continuous 30 A for 0.5 s
Total current on common path		5 A continuous 30 A for 0.5 s
<hr/>		
Binary inputs, number		3 (can be marshalled)
Nominal operating voltage		24 to 250 Vdc; bipolar
Current consumption, energized		approx. 1,8 mA, independent of control voltage
Pick-up threshold		reconnectable by solder bridges
– rated aux. voltage 24/48/60 Vdc	$U_{pick-up}$ $U_{drop-off}$	≥ 19 Vdc < 14 Vdc
– rated aux. voltage 110/125/220/250 Vdc	$U_{pick-up}$ $U_{drop-off}$	≥ 88 Vdc < 66 Vdc
Max permissible control voltage		300 Vdc
<hr/>		
Serial operator interface		isolated
– connection		non-isolated at the front panel, 9-pin DSUB port for connecting a personal computer
– transmission speed		min. 1200 Baud; max. 19200 Baud as delivered 9600 Baud; parity 8E1
– max. transmission distance		15 m
<hr/>		
Serial service/modem interface		
– connection		isolated RS232/RS485/optical fibre depend. on ordered model with DIGSI® 3
– operation		
– transmission speed		min. 1200 Baud; max. 19200 Baud as delivered 9600 Baud
<hr/>		
RS232		
– Connection	for flush mounted case for panel surface mounted case	rear panel; mounting location "C"; 9-pin DSUB port at the double-deck terminal on the case bottom shielded data cable
– Test voltage		500 V; 50 Hz
– max. transmission distance		15 m
<hr/>		
RS485		
– Connection	for flush mounted case for panel surface mounted case	rear panel; mounting location "C"; 9-pin DSUB port at the double-deck terminal on the case bottom shielded data cable
– Test voltage		500 V; 50 Hz
– max. transmission distance		1000 m
<hr/>		
Optical fibre		
– Connection	for flush mounted case for panel surface mounted case	rear panel; mounting location "C"; ST–connector on the case bottom
– optical vawe length		820 nm
– Laser class 1 acc. EN 60825–1/–2		using glass fibre 50/125 μ m or 62.5/125 μ m
– permissible signal attenuation		6 dB with glass fiber 62.5/125 μ m
– max. transmission distance		1500 m
– character idle state		selectable; factory setting "Light off"

3.1.2 Electrical tests

Insulation tests

Standards:	IEC 60255–5; ANSI/IEEE C37.90.0
– High voltage test (routine test) except power supply input, binary inputs, and communication interfaces	2 kV (rms); 50 Hz
– High voltage test (routine test) only d.c. voltage supply input and RS485	2.8 kV dc
– High voltage test (routine test) only isolated serial interface	500 V (rms); 50 Hz
– Impulse voltage test (type test) all circuits except communication interfaces, class III	5 kV (peak); 1.2/50 μ s; 0.5 J; 3 positive and 3 negative shots at intervals of 5 s

EMC tests; immunity (type tests)

Standards:	IEC 60255–6, IEC 60255–22 (product standards) EN 50082–2 (generic standard) VDE 0435 /part 303
– High frequency IEC 60255–22–1, class III	2.5 kV (peak); 1 MHz; $\tau = 15 \mu$ s; 400 shots/s; duration 2 s
– Electrostatic discharge IEC 60255–22–2 class IV and IEC 61000–4–2, class IV	8 kV contact discharge; 15 kV air discharge; both polarities; 150 pF; $R_i = 330 \Omega$
– Radio-frequency electromagnetic field, non-modulated; IEC 60255–22–3 (report) class III	10 V/m; 27 MHz to 500 MHz
– Radio-frequency electromagnetic field, amplitude modulated; IEC 61000–4–3, class III	10 V/m; 80 MHz to 1000 MHz; 80 % AM; 1 kHz
– Radio-frequency electromagnetic field, pulse modulated; IEC 61000–4–3/ENV 50204, class III	10 V/m; 900 MHz; repetition frequency 200 Hz; duty cycle 50 %
– Fast transients IEC 60255–22–4 and IEC 61000–4–4, class IV	4 kV; 5/50 ns; 5 kHz; burst length 15 ms; repetition rate 300 ms; both polarities; $R_i = 50 \Omega$; duration 1 min
– High energy surge voltages (SURGE), IEC 61 000–4–5; installation class 3 power supply	impulse: 1,2/50 μ s common mode: 2 kV; 12 Ω ; 9 μ F diff. mode: 1 kV; 2 Ω ; 18 μ F
analog inputs, binary inputs and outputs	common mode: 2 kV; 42 Ω ; 0.5 μ F diff. mode: 1 kV; 42 Ω ; 0.5 μ F
– Conducted disturbances induced by radio-frequency fields, amplitude modulated IEC 61000–4–6, class III	10 V; 150 kHz to 80 MHz; 80 % AM; 1 kHz
– Power frequency magnetic field IEC 61000–4–8, class IV IEC 60255–6	30 A/m continuous; 300 A/m for 3 s; 50 Hz 0.5 mT; 50 Hz

Further EMC tests; immunity (type tests)

– Oscillatory surge withstand capability ANSI/IEEE C37.90.1	2.5 kV to 3 kV (peak); 1 MHz to 1.5 MHz, decaying oscillation; 50 shots per s; duration 2 s; $R_i = 150 \Omega$ to 200Ω
– Fast transient surge withstand capability ANSI/IEEE C37.90.1	4 kV to 5 kV; 10/150 ns; 50 shots per s; both polarities; duration 2 s; $R_i = 80 \Omega$
– Radiated electromagnetic interference ANSI/IEEE C37.90.2	35 V/m; 25 MHz to 1000 MHz;
– Decaying oscillation IEC 60694 or IEC 61000-4-2	2.5 kV (peak, alternating polarity); 100 kHz, 1 MHz, 10 MHz, and 50 MHz; $R_i = 200 \Omega$

EMC tests; emission (type tests)

Standard:	EN 50081-★ (generic standard)
– Conducted interference voltage, aux. voltage CISPR 22, EN 55022, class B	150 kHz to 30 MHz
– Interference field strength CISPR 22, EN 55022, class B	30 MHz to 1000 MHz
– Harmonic currents on the network lead at 230 Vac; IEC 61000-3-2	Device is to be assigned Class D (applies only for devices with >50VA power consumption)
– Voltage variations and flicker on the network lead at 230 Vac; IEC 61000-3-3	Limits are observed

3.1.3 Mechanical stress tests**Vibration and shock during operation**

Standards:	IEC 60255-21 and IEC 60068-2
– Vibration IEC 60255-21-1, class 1 IEC 60068-2-6	sinusoidal 10 Hz to 60 Hz: ± 0.035 mm amplitude; 60 Hz to 150 Hz: 0.5 g acceleration sweep rate 1 octave/min 20 cycles in 3 orthogonal axes
– Shock IEC 60255-21-2, class 1	half sine acceleration 5 g, duration 11 ms, 3 shocks in each direction of 3 orthogonal axes
– Seismic vibration IEC 60255-21-3, class 1 IEC 60068-3-3	sinusoidal 1 Hz to 8 Hz: ± 3.5 mm amplitude (hor. axis) 1 Hz to 8 Hz: ± 1.5 mm amplitude (vert. axis) 8 Hz to 35 Hz: 1 g acceleration (hor. axis) 8 Hz to 35 Hz: 0.5 g acceleration (vert. axis) sweep rate 1 octave/min 1 cycle in 3 orthogonal axes

Vibration and shock during transport

Standards:	IEC 60255–21 and IEC 60068–2
– Vibration IEC 60255–21–1, class 2 IEC 60068–2–6	sinusoidal 5 Hz to 8 Hz: ± 7.5 mm amplitude; 8 Hz to 150 Hz: 2 g acceleration sweep rate 1 octave/min 20 cycles in 3 orthogonal axes
– Shock IEC 60255–21–2, class 1 IEC 60068–2–27	half sine acceleration 15 g, duration 11 ms, 3 shocks in each direction of 3 orthogonal axes
– Continuous shock IEC 60255–21–2, class 1 IEC 60068–2–29	half sine acceleration 10 g, duration 16 ms, 1000 shocks each direction of 3 orthogonal axes

3.1.4 Climatic stress tests

– recommended temperature during service	–5 °C to +55 °C	(> 55 °C decreased display contrast)
– permissible temperature during service	–20 °C to +70 °C	
– permissible temperature during storage	–25 °C to +55 °C	
– permissible temperature during transport	–25 °C to +70 °C	

Storage and transport with standard works packaging!

– Permissible humidity	mean value per year ≤ 75 % relative humidity; on 30 days per year 95 % relative humidity; condensation not permissible!
------------------------	--

We recommend that all units are installed such that they are not subjected to direct sunlight, nor to large temperature fluctuations which may give rise to condensation.

3.1.5 Service conditions

The relay is designed for use in industrial environment, for installation in standard relay rooms and compartments so that with proper installation **electro-magnetic compatibility (EMC)** is ensured. The following should also be heeded:

- All contactors and relays which operate in the same cubicle or on the same relay panel as the digital protection equipment should, as a rule, be fitted with suitable spike quenching elements.
- All external connection leads in sub-stations from 100 kV upwards should be screened with a screen capable of carrying power currents and earthed at both sides. No special measures are normally necessary for sub-stations of lower voltages.
- The screen of the interface cable – if used – must be earthed.
- It is not permissible to withdraw or insert individual modules under voltage. In the withdrawn condition, some components are electrostatically endangered; during handling the standards for electrostatically endangered components must be observed. The modules are not endangered when plugged in.

3.1.6 Design

Housing	7XP20; refer to Section 2.1		
Dimensions	refer to Section 2.2		
Weight			
– in housing for surface mounting	approx. 4.5 kg		
– in housing for flush mounting	approx. 4.0 kg		
Degree of protection acc. to EN 60529			
– for the equipment			
in the surface mounted case	front	IP 51	
in the flush mounted case	rear	IP 51	
		IP 20	
– for personal protection	IP 2x terminals covered with cap		

3.2 Definite time overcurrent protection

Setting range/steps

Overcurrent pick-up $I >$ (phases)	I/I_N	0.1 to 25.0	(steps 0.1); or ∞
Overcurrent pick-up $I_{E >}$ (earth)	I/I_N	0.05 to 25.00	(steps 0.1); or ∞
Overcurrent pick-up $I >>$ (phases)	I/I_N	0.1 to 25.0	(steps 0.1); or ∞
Overcurrent pick-up $I_{E >>}$ (earth)	I/I_N	0.05 to 25.00	(steps 0.1); or ∞
Overcurrent pick-up $I >>>$ (phases)	I/I_N	0.3 to 12.5	(steps 0.1); or ∞
Delay times T for $I >$, $I_{E >}$, $I >>$ and $I_{E >>}$		0.00 s to 60.00 s	(steps 0.01 s)

The set times are pure delay times.

Pick-up times

$I >$, $I >>$, $I_{E >}$, $I_{E >>}$	
– at 2 x setting value, without meas. repetition	approx. 27 ms
– at 2 x setting value, with meas. repetition	approx. 40 ms
Pick-up times for $I >>>$ at 2 x setting value	approx. 18 ms

Reset times

$I >$, $I >>$, $I >>>$, $I_{E >}$, $I_{E >>}$	approx. 30 ms
---	---------------

Reset ratios

approx. 0.95
All reset values are based on the stage with the smallest setting value

Overshot time

approx. 35 ms

Tolerances

– Pick-up values $I >$, $I >>$, $I >>>$, $I_{E >}$, $I_{E >>}$	5 % of setting value or 5 % of rated value
– Delay times T	1 % of setting value or 10 ms

Influence variables

– Auxiliary voltage in range $0.8 \leq U_H/U_{HN} \leq 1.2$	$\leq 1 \%$
– Temperature in range $0 \text{ }^\circ\text{C} \leq \vartheta_{\text{amb}} \leq 40 \text{ }^\circ\text{C}$	$\leq 0.5 \%/10 \text{ K}$
– Frequency in range $0.98 \leq f/f_N \leq 1.02$	$\leq 1.5 \%$
– Frequency in range $0.95 \leq f/f_N \leq 1.05$	$\leq 2.5 \%$
– Harmonics up to 10 % of 3rd harmonic	$\leq 1 \%$
up to 10 % of 5th harmonic	$\leq 1 \%$

3.3 Inverse time overcurrent protection

Setting range/steps

Overcurrent pick-up $I_p >$ (phases)	I/I_N	0.1 to 4.0	(steps 0.1)
Overcurrent pick-up $I_{Ep} >$ (earth)	I/I_N	0.05 to 4.00	(steps 0.1)
Time multiplier for I_p, I_{Ep}	T_p (IEC charac.)	0.05 to 3.20 s	(steps 0.01 s)
	D (ANSI charac.)	0.5 to 15.0 s	(steps 0.1 s)
Overcurrent pick-up $I >>$ (phases)	I/I_N	0.1 to 25.0	(steps 0.1); or ∞
Overcurrent pick-up $I >>>$ (phases)	I/I_N	0.3 to 12.5	(steps 0.1); or ∞
Overcurrent pick-up $I_{E>>}$ (earth)	I/I_N	0.05 to 25.00	(steps 0.1); or ∞
Delay time for $I >>, I_{E>>}$	T	0.00 s to 60.00 s	(steps 0.01 s)

Trip time characteristics acc. IEC

acc. IEC 60255–3 and BS 142
(refer to Figures 3.1 and 3.2)

<u>Normal inverse ("inverse")</u>	(IEC 60255–3 type A)	$T = \frac{0.14}{(I/I_p)^{0.02} - 1} \cdot T_p$
<u>Very inverse ("short in")</u>	(IEC 60255–3 type B)	$T = \frac{13.5}{(I/I_p)^1 - 1} \cdot T_p$
<u>Extremely inverse ("extr.inv")</u>	(IEC 60255–3 type C)	$T = \frac{80}{(I/I_p)^2 - 1} \cdot T_p$
<u>Long time inverse ("long inv")</u>	(IEC 60255–3 type B)	$T = \frac{120}{(I/I_p)^1 - 1} \cdot T_p$

where:

t	tripping time
T_p	set time multiplier
I	fault current
I_p	set pick-up value

in the range $1.1 \leq I/I_p \leq 20$;
tripping times do not decrease above $I/I_p > 20$

Pick-up threshold of inverse time stages approx. $1.1 \cdot I_p$

Drop-off threshold of inverse time stages approx. $1.03 \times I_p$
Drop-off time approx. 30 ms

Tolerances

– Pick-up values	5 % of set value or 5 % of rated value
– Delay time for $2 \leq I/I_p \leq 20$ and $0.5 \leq I/I_N \leq 24$	5 % of theoretical value ± 2 % current tolerance; at least 30 ms

Influence variables

– Auxiliary voltage in range $0.8 \leq U_H/U_{HN} \leq 1.2$	≤ 1 %
– Temperature in range $-5 \text{ °C} \leq \vartheta_{amb} \leq 40 \text{ °C}$	≤ 0.5 %/10 K
– Frequency in range $0.95 \leq f/f_N \leq 1.05$	≤ 8 % referred to theoretical time value

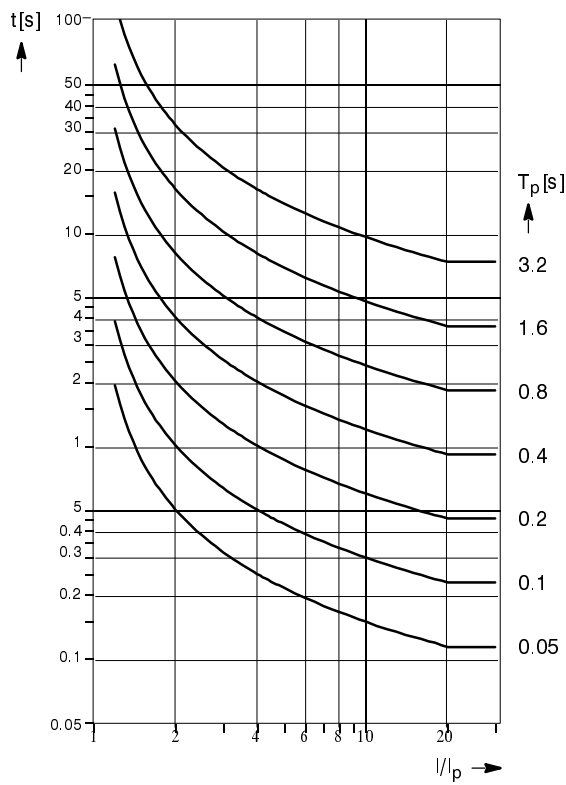

Normal inverse:
$$t = \frac{0.14}{(I/I_p)^{0.02} - 1} \cdot T_p \text{ [s]}$$

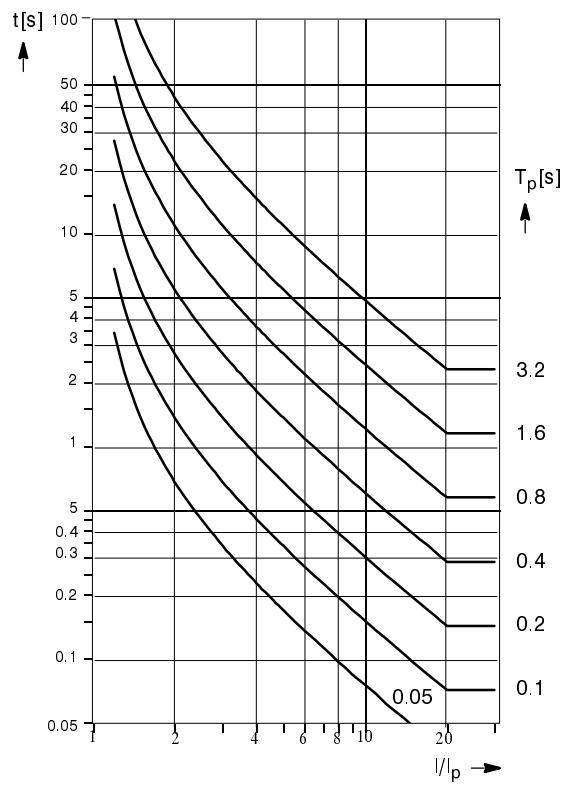

Very inverse:
$$t = \frac{13.5}{(I/I_p) - 1} \cdot T_p \text{ [s]}$$

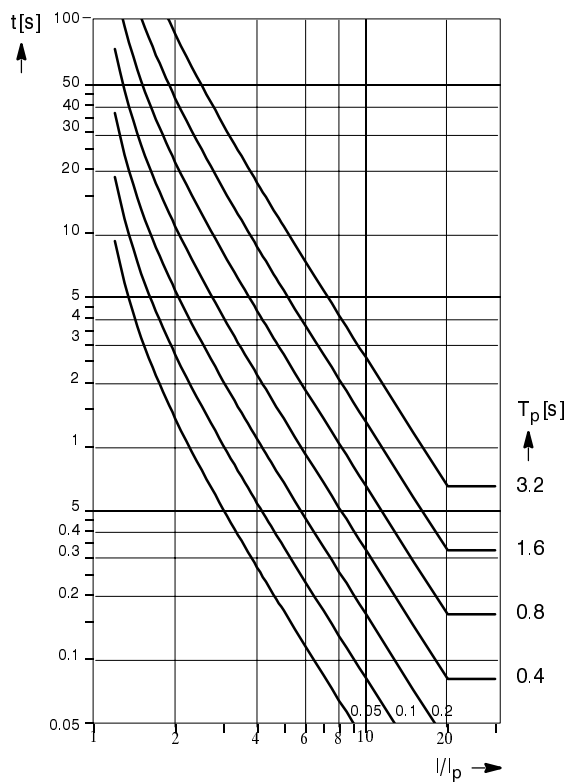

Extremely inverse:
$$t = \frac{80}{(I/I_p)^2 - 1} \cdot T_p \text{ [s]}$$

- t trip time
- T_p set time multiplier
- I Fault current
- I_p Set pick-up current

Note: For earth faults read I_{Ep} instead of I_p and T_{Ep} instead of T_p

Figure 3.1 Trip time characteristics of inverse time overcurrent protection, according IEC

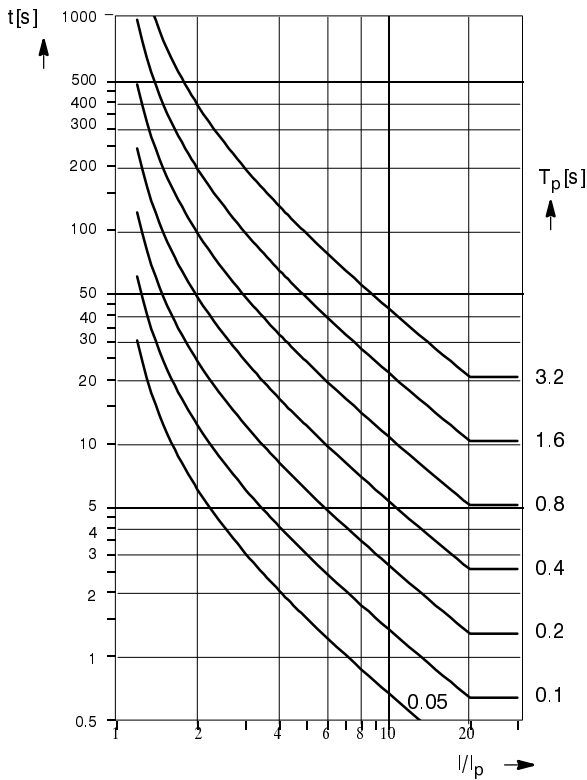

Long time inverse
$$t = \frac{120}{(I/I_p)^1 - 1} \cdot T_p \text{ [s]}$$

- t trip time
- T_p set time multiplier
- I Fault current
- I_p Set pick-up current

Note: For earth faults read I_{Ep} instead of I_p and T_{Ep} instead of T_p

Figure 3.2 Trip time characteristic of inverse time overcurrent protection, according IEC

Note concerning the characteristics Figure 3.2:

The time scale of the *long time inverse* characteristic differs from that of the characteristics in Figure 3.1 by the factor 10.

Trip time characteristics acc. ANSI/IEEE

(refer to Figures 3.3 and 3.4)

<u>Inverse</u>	$t = \left(\frac{8.9341}{(I/I_p)^{2.0938} - 1} + 0.17966 \right) \cdot D$
<u>Short inverse ("short inv")</u>	$t = \left(\frac{0.2663}{(I/I_p)^{1.2969} - 1} + 0.03393 \right) \cdot D$
<u>Long inverse ("long inv")</u>	$t = \left(\frac{5.6143}{(I/I_p) - 1} + 2.18592 \right) \cdot D$
<u>Moderately inverse ("mode inv")</u>	$t = \left(\frac{0.0103}{(I/I_p)^{0.02} - 1} + 0.0228 \right) \cdot D$
<u>Very inverse ("very inv")</u>	$t = \left(\frac{3.922}{(I/I_p)^2 - 1} + 0.0982 \right) \cdot D$
<u>Extremely inverse ("extr inv")</u>	$t = \left(\frac{5.64}{(I/I_p)^2 - 1} + 0.02434 \right) \cdot D$
<u>definite inverse ("def inv")</u>	$t = \left(\frac{0.4797}{(I/I_p)^{1.5625} - 1} + 0.21359 \right) \cdot D$
<u>I-squared-t ("IsquaredT")</u>	$t = \frac{50.7 \cdot D + 10.14}{(I/I_p)^2}$

where:

t tripping time
D set time multiplier
I fault current
I_p set pickup value

Pick-up thresholdapprox. 1.06 · I_p**Drop-off threshold**approx. 1.01 · I_p**Tolerances**

– Pick-up values	5 % of set value or 5 % of rated value
– Delay time for $2 \leq I/I_p \leq 20$ and $0.5 \leq I/I_N \leq 24$	5 % of theoretical value ± 2 % current tolerance; at least 30 ms

Influence variables

– Auxiliary voltage in range $0.8 \leq U_H/U_{HN} \leq 1.2$	≤ 1 %
– Temperature in range $-5 \text{ °C} \leq \vartheta_{amb} \leq 40 \text{ °C}$	≤ 0.5 %/10 K
– Frequency in range $0.95 \leq f/f_N \leq 1.05$	≤ 8 % referred to theoretical time value

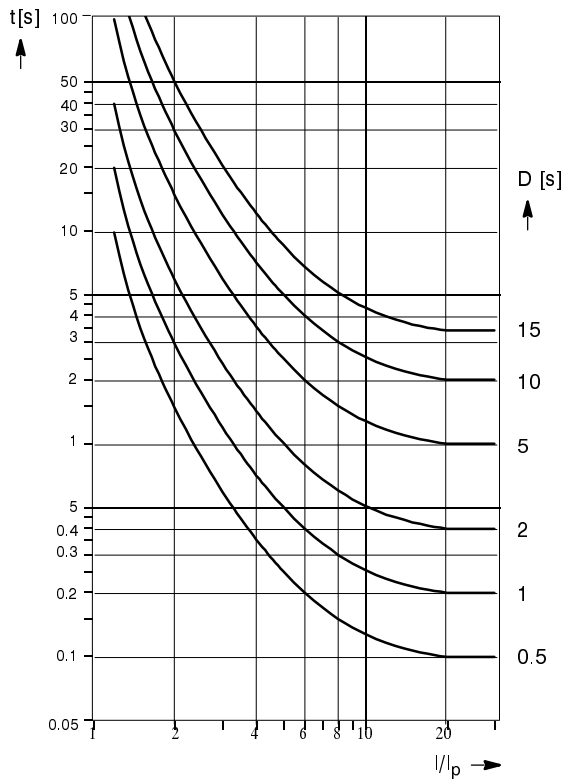

Inverse:
$$t = \left(\frac{8.9341}{(I/I_p)^{2.0938} - 1} + 0.17966 \right) \cdot D \text{ [s]}$$

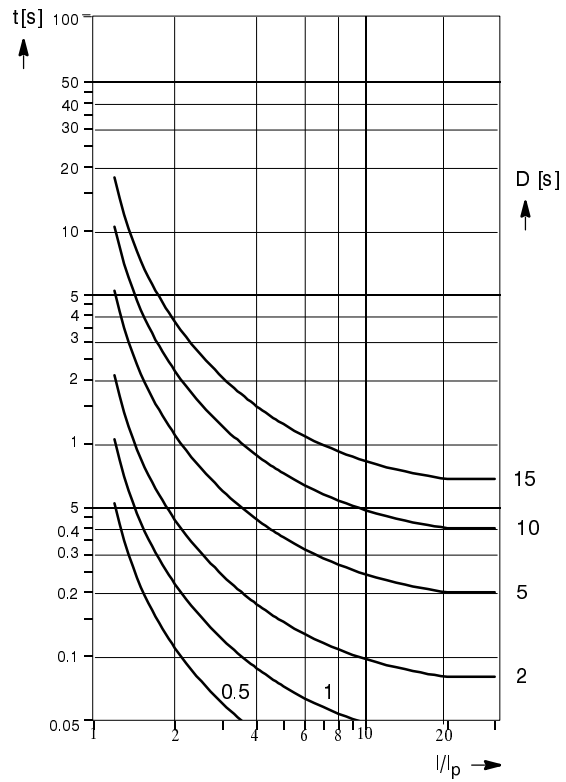

short inverse:
$$t = \left(\frac{0.2663}{(I/I_p)^{1.2969} - 1} + 0.03393 \right) \cdot D \text{ [s]}$$

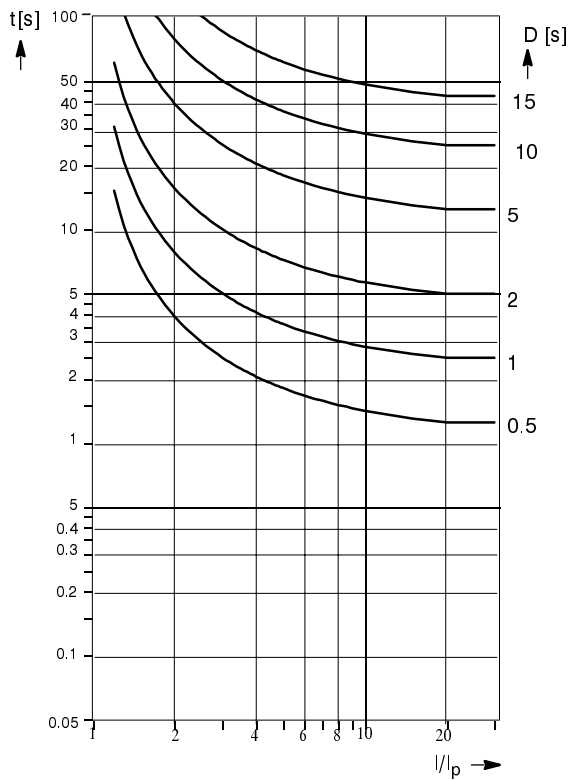

long inverse:
$$t = \left(\frac{5.6143}{(I/I_p) - 1} + 2.18592 \right) \cdot D \text{ [s]}$$

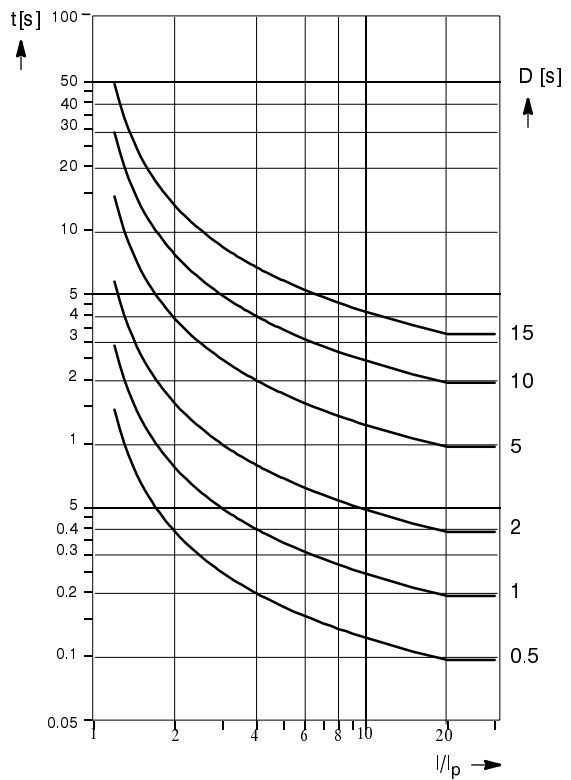

moderately inverse:
$$t = \left(\frac{0.0103}{(I/I_p)^{0.02} - 1} + 0.0228 \right) \cdot D \text{ [s]}$$

Figure 3.3 Trip time characteristic of inverse time overcurrent protection, according ANSI/IEEE

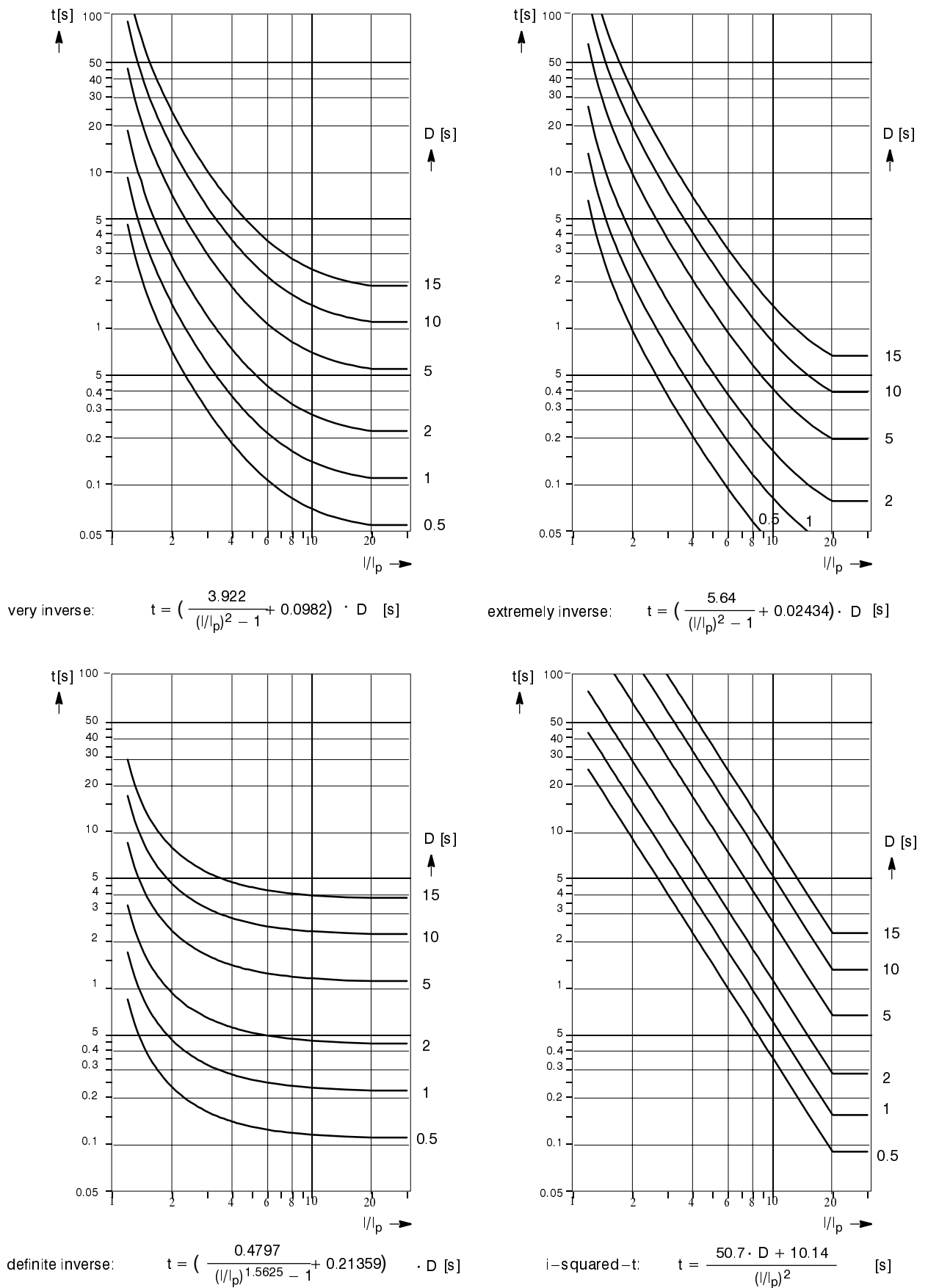

Figure 3.4 Trip time characteristic of inverse time overcurrent protection, according ANSI/IEEE

3.4 Unbalanced load protection

Setting ranges/steps

Tripping stage $I_{2>}$	8 % to 80 % of I_N	(steps 1 %)
Tripping stage $I_{2>>}$	8 % to 80 % of I_N	(steps 1 %)
Time delays $T(I_{2>})$, $T(I_{2>>})$	0.00 s to 60.00 s	(steps 0.01 s)

Lower function limit at least one phase current $\geq 0.1 \cdot I_N$

Pick-up times

- Tripping stage $I_{2>}$, tripping stage $I_{2>>}$
- but with currents $I/I_N > 1.5$ (overcurrent case)
- or neg. sequence current $< (\text{set value} + 0.1 \cdot I_N)$

at $f_N = 50$ Hz	at $f_N = 60$ Hz
approx. 60 ms	approx. 75 ms
approx. 200 ms	approx. 310 ms

Reset times

- Tripping stage $I_{2>}$, tripping stage $I_{2>>}$

at $f_N = 50$ Hz	at $f_N = 60$ Hz
approx. 35 ms	approx. 42 ms

Reset ratios

- Tripping stage $I_{2>}$, tripping stage $I_{2>>}$ approx. $0.9 - 0.01 \cdot I_N$

Tolerances

- pick-up values $I_{2>}$, $I_{2>>}$ current $I/I_N \leq 1.5$ 5 % of rated value
- current $I/I_N > 1.5$ 5 % of rated value
- stage delay times ± 1 % but min. 10 ms

Influence variables

- Auxiliary d.c. voltage
in range $0.8 \leq U_H/U_{HN} \leq 1.2$ ≤ 1 %
- Temperature
in range $-5 \text{ °C} \leq \vartheta_{\text{amb}} \leq +40 \text{ °C}$ ≤ 0.5 %/10 K
- Frequency
in range $0.98 \leq f/f_N \leq 1.02$ ≤ 2 % of I_N
- in range $0.95 \leq f/f_N \leq 1.05$ ≤ 5 % of I_N

3.5 Thermal overload protection

3.5.1 Overload protection with memory (total memory according to IEC 60255–8)

Setting ranges/steps

Factor k according to IEC 60255–8	0.40 to 2.00	(steps 0.01)
Thermal time constant τ_{th}	1.0 to 999.9 min	(steps 0.1 min)
Thermal warning stage $\Theta_{warn}/\Theta_{trip}$	50 to 99 % referred to trip temperature rise	(steps 1 %)
Prolongation factor at motor stand-still k_{τ}	1.00 to 10.00	(steps 0.01)

Trip time characteristic

$$t = \tau_{th} \cdot \ln \frac{(I / k \cdot I_N)^2 - (I_{pre} / k \cdot I_N)^2}{(I / k \cdot I_N)^2 - 1}$$

t	trip time
τ_{th}	time constant
I	load current
I_{pre}	preload current
k	factor according to IEC 60255–8 refer also Figures 3.5 and 3.6

in the range $I/k \cdot I_N \leq 8$; tripping times do not decrease above $I/I_p > 8$

Reset ratios

Θ / Θ_{trip}	reset below Θ_{warn}
Θ / Θ_{warn}	approx. 0.99

Tolerances

– referring to $k \cdot I_N$	$\pm 5 \%$	class 5% acc. IEC 60255–8
– referring to trip time	$\pm 5 \%$ ± 2 s	class 5% acc. IEC 60255–8

Influence variables referred to $k \cdot I_N$

– Auxiliary dc voltage in range $0.8 \leq U_H/U_{HN} \leq 1.2$	$\leq 1 \%$
– Temperature in range $-5 \text{ °C} \leq \vartheta_{amb} \leq +40 \text{ °C}$	$\leq 0.5 \%/10 \text{ K}$
– Frequency in range $0.95 \leq f/f_N \leq 1.05$	$\leq 1 \%$

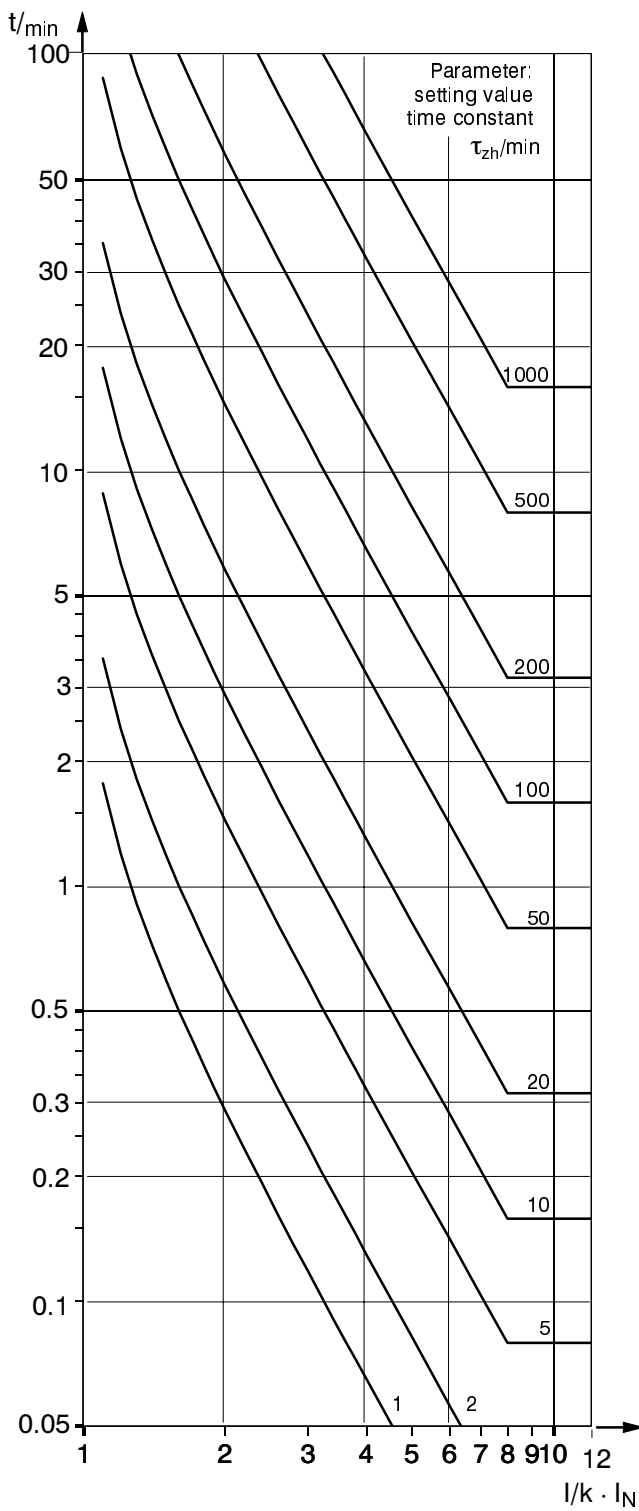

$$t = \tau_{th} \cdot \ln \frac{(I / k \cdot I_N)^2}{(I / k \cdot I_N)^2 - 1}$$

Figure 3.5 Trip time characteristic of overload protection – with total memory – (without preload)

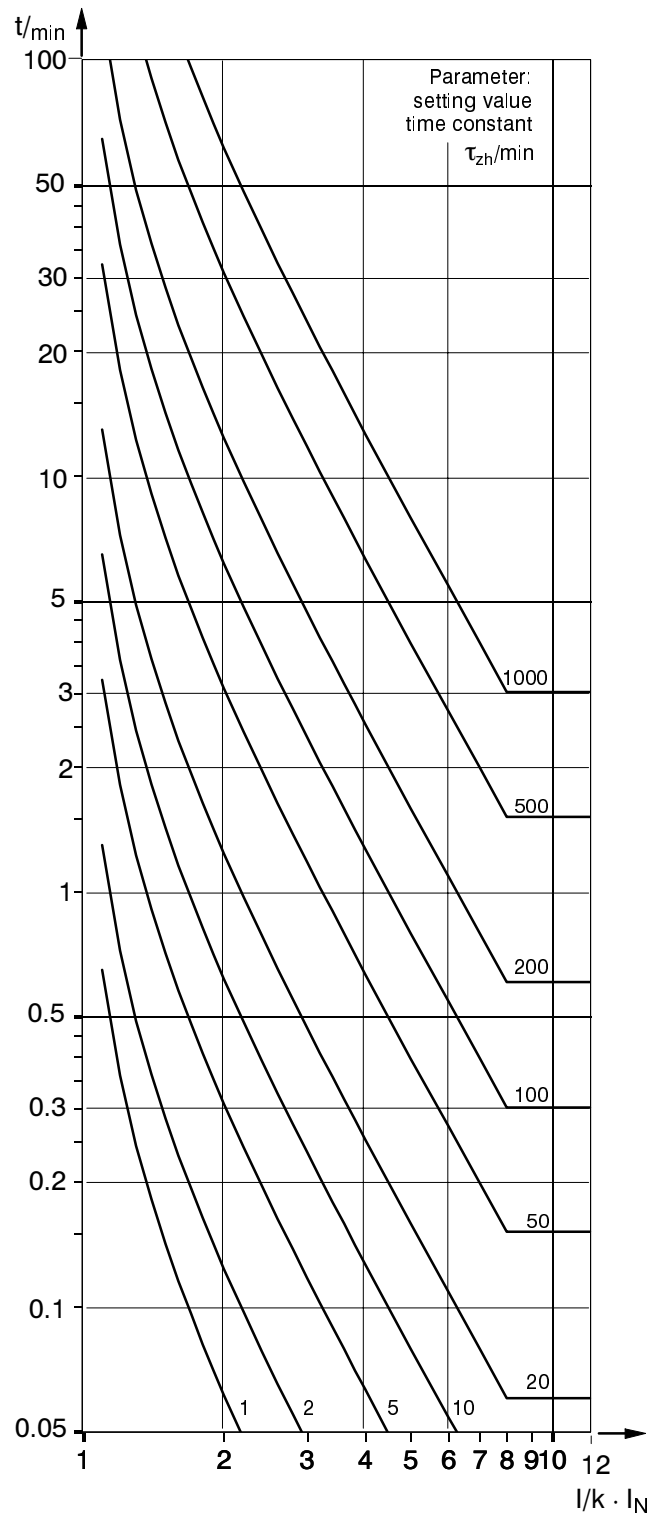

$$t = \tau_{th} \cdot \ln \frac{(I / k \cdot I_N)^2 - (I_{pre} / k \cdot I_N)^2}{(I / k \cdot I_N)^2 - 1}$$

for 90 % preload

Figure 3.6 Trip time characteristic of overload protection – with total memory – (with 90 % preload)

3.5.2 Overload protection without memory

Setting ranges/steps

Pick-up value	I_L/I_N	0.4 to 4.0	(steps 0.1)
Time multiplier	$t_L (= t_6\text{-time})$	1.0 to 120.0 s	(steps 0.1 s)

Trip time characteristic

$$t = \frac{35}{(I / I_L)^2 - 1} \cdot t_L \quad \text{for } I > 1.1 \cdot I_L$$

t	trip time
t_L	time multiplier (= tripping time for six times current setting I_L)
I	load current
I_L	pick-up current

refer also to Figure 3.7

Reset ratio	I/I_L	approx. 0.94
-------------	---------	--------------

Tolerances

– referring to pick-up threshold $1.1 \cdot I_L$	$\pm 5 \%$
– referring to trip time	$\pm 5 \% \pm 2 \text{ s}$

Influence variables

– Auxiliary dc voltage in range $0.8 \leq U_H/U_{HN} \leq 1.2$	$\leq 1 \%$
– Temperature in range $-5 \text{ °C} \leq \vartheta_{\text{amb}} \leq +40 \text{ °C}$	$\leq 0.5 \%/10 \text{ K}$
– Frequency in range $0.95 \leq f/f_N \leq 1.05$	$\leq 1 \%$

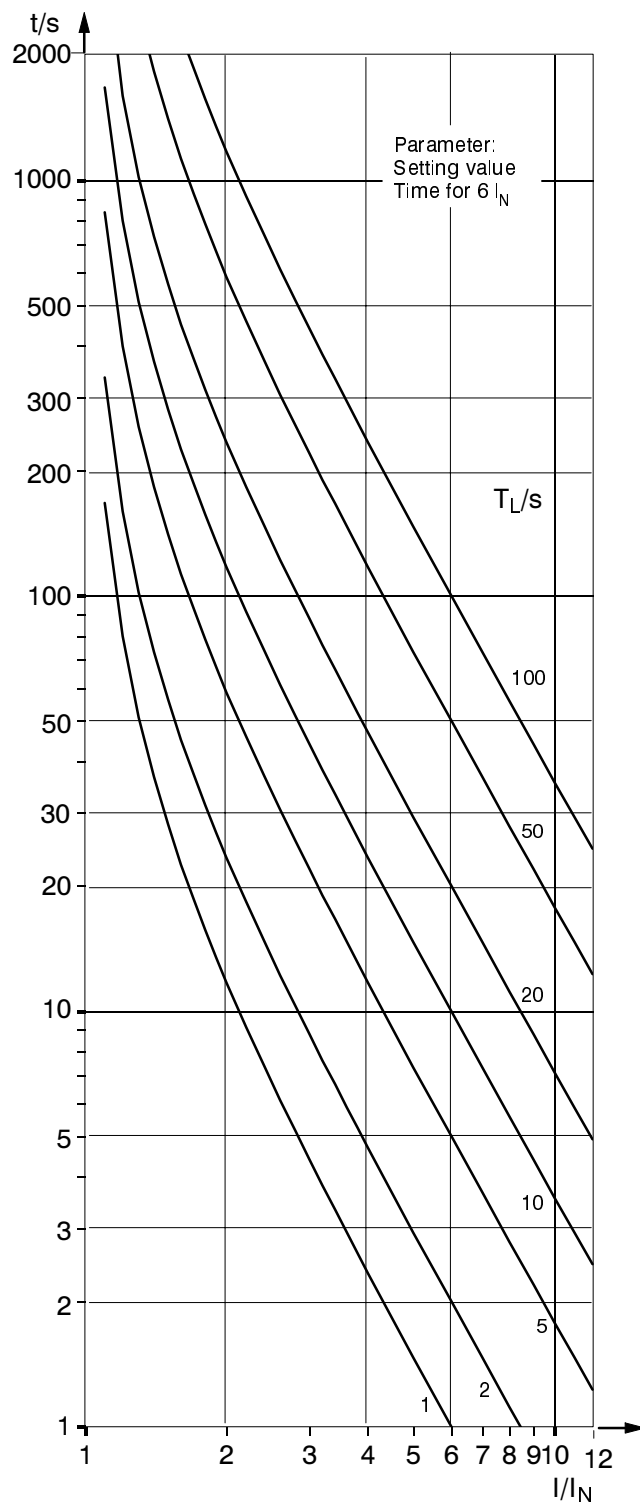

$$t = \frac{35}{(I/I_L)^2 - 1} \cdot T_L$$

Figure 3.7 Trip time characteristic of overload protection – without memory –

3.6 Start-up time monitoring

Setting ranges/steps

Permissible start-up current	I_{start}/I_N	0.4 to 20.0 (steps 0.1)
Permissible start-up time	t_{start}	1.0 s to 360.0 s (steps 0.1 s)

Tripping characteristic

$$t = \left(\frac{I_{\text{start}}}{I_{\text{rms}}} \right)^2 \cdot t_{\text{start}} \quad \text{for } I_{\text{rms}} > I_{\text{start}}$$

Reset ratio

$$I_{\text{rms}}/I_{\text{start}} \quad \text{approx 0.94}$$

Tolerances

Pick-up value	5 %
Delay time	5 % of setting value or 330 ms

3.7 Auto-reclosure (optional)

Number of possible shots	1 up to 9
Auto-reclose modes	three-pole
Dead time for 1st shot	0.05 s to 1800.00 s (steps 0.01 s)
Dead time for 2nd shot	0.05 s to 1800.00 s (steps 0.01 s)
Dead time for 3rd shot	0.05 s to 1800.00 s (steps 0.01 s)
Dead time for fourth and any further shot	0.05 s to 1800.00 s (steps 0.01 s)
Reclaim time after successful AR	0.05 s to 320.00 s (steps 0.01 s)
Lock-out time after unsuccessful AR	0.05 s to 320.00 s (steps 0.01 s)
Reclaim time after manual close	0.50 s to 320.00 s (steps 0.01 s)
Duration of RECLOSE command	0.01 s to 60.00 s (steps 0.01 s)

3.8 Ancillary functions

Operational value measurements

– operational current values	$I_{L1}; I_{L2}; I_{L3}$
measurement range	0 % to 240 % I_N
tolerance	3 % of rated value or of measured value
– thermal overload values	
calculated temperature rises	Θ/Θ_{trip}
measurement range	0 % to 300 %
tolerance	5 % referred to Θ_{trip}

Fault event data storage

storage of annunciations of the last eight faults

Time assignment

resolution for operational annunciations	1 s
resolution for fault event annunciations	1 ms
max time deviation	0.01 %

Data storage for fault recording

max. 8 fault events

total storage time (fault detection or trip command = 0 ms)

max. 5 s, selectable pre-trigger and post-fault time

max. storage period per fault event	T_{max}	0.30 to 5.00 s (steps 0.01 s)
pre-trigger time	T_{pre}	0.05 to 0.50 s (steps 0.01 s)
post-fault time	T_{post}	0.05 to 0.50 s (steps 0.01 s)

sampling rate	1 instantaneous value per ms at 50 Hz 1 instantaneous value per 0.83 ms at 60 Hz
---------------	---

Trip circuit supervision

with one or two binary inputs

Circuit breaker trip test

with live trip or
trip/reclose cycle (models with auto-reclosure)

4 Method of operation

4.1 Operation of complete unit

The numerical time overcurrent protection SIPROTEC 7SJ602 is equipped with a powerful and proven 16-bit micro-controller. This provides fully digital processing of all functions from data acquisition of measured values to the trip and close signals to the circuit breaker.

Figure 4.1 shows the base structure of the unit.

The transducers of the measured value input section ME transform the currents from the measurement transformers of the switch-gear and match them to the internal processing level of the unit.

Apart from the galvanic and low-capacitive isolation provided by the input transformers, filters are provided for the suppression of interference. The filters have been optimized with regard to bandwidth and processing speed to suit the measured value processing. The matched analog values are then passed to the analog input section AE.

The analog input section AE contains input amplifiers for each input, analog-to-digital converters and memory circuits for the data transfer to the microprocessor.

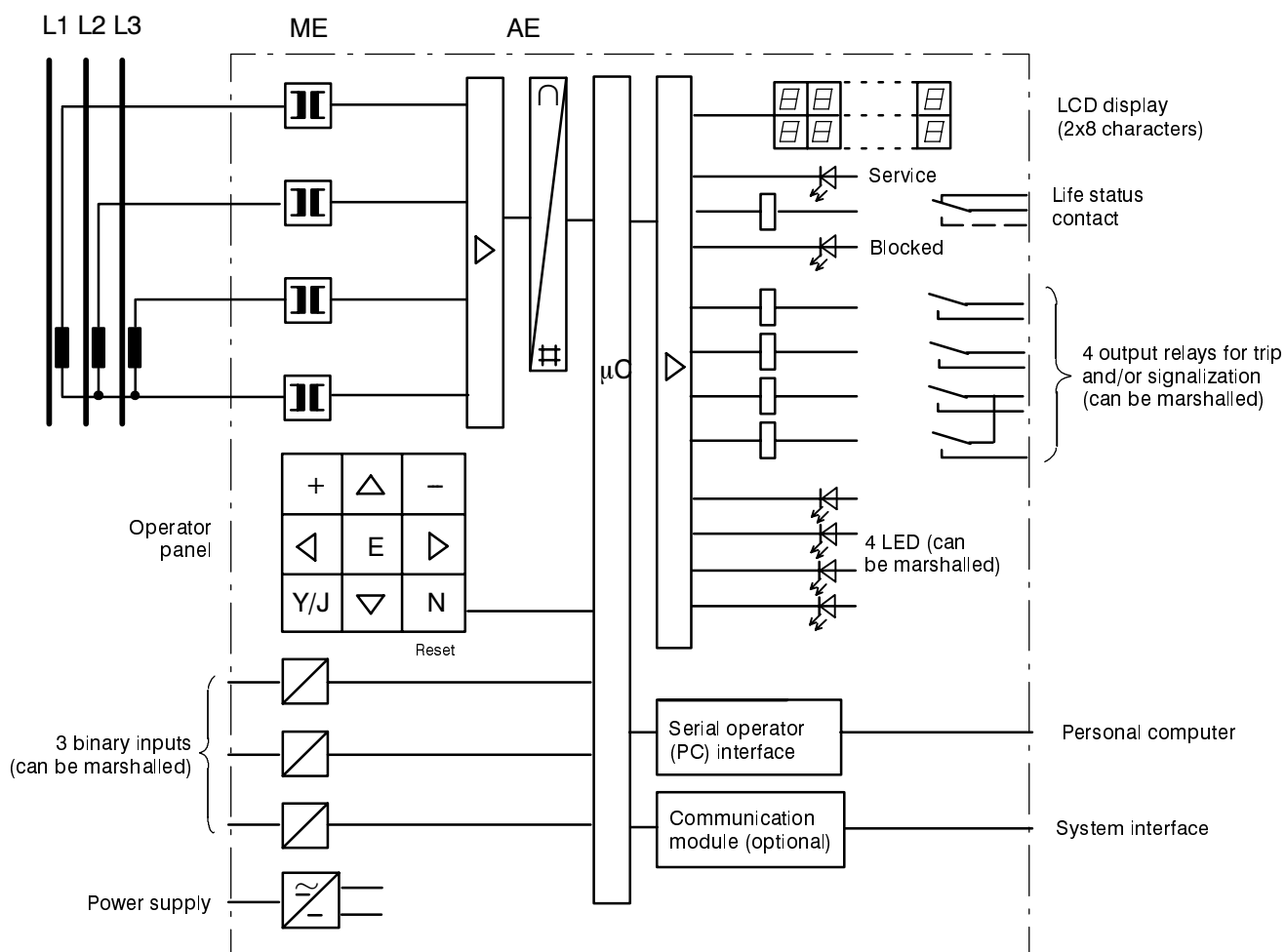

Figure 4.1 Hardware-structure of time overcurrent protection relay 7SJ602

Apart from control and supervision of the measured values, the microprocessor processes the actual protective functions. These include in particular:

- filtering and formation of the measured quantities,
- scanning of limit values and time sequences,
- calculation of the trip time in accordance with the selected characteristic,
- calculation of negative and positive sequence currents for unbalanced load detection,
- calculation of r.m.s. values for overload detection,
- decision about trip and reclose commands,
- storage of measured quantities during a fault for analysis.

Binary inputs and outputs to and from the processor are channelled via the input/output elements. From these the processor receives information from the switch-gear (e.g. remote resetting) or from other

equipment (e.g. blocking signals). Outputs include, in particular, trip and reclose commands to the circuit breakers, signals for remote signalling of important events and conditions as well as visual indicators (LEDs), and an alphanumeric display on the front.

An integrated membrane keyboard in connection with a built-in alphanumeric LCD display enables communication with the unit. All operational data such as setting values, plant data, etc. are entered into the protection from this panel (refer to Section 6.3). Using this panel the parameters can be recalled and the relevant data for the evaluation of a fault can be read out after a fault has occurred (refer to Section 6.4). The dialog with the relay can be carried out alternatively via the serial interface by means of personal computer.

A power supply unit provides the auxiliary supply to the described functional units with +5 V. Transient failures in the supply voltage, up to 50 ms which may occur during short-circuits in the d.c. supply system of the plant are bridged by a d.c. voltage storage element.

4.2 Time overcurrent protection

The time overcurrent protection can be used as definite time and as inverse time overcurrent protection. Four standardized inverse time characteristics according to IEC 60255–3 and eight standardized inverse time characteristics according to ANSI/IEEE are available for inverse time mode. The trip time characteristics and the applied formulae are given in the Technical data, refer to Figures 3.1 to 3.4, Section 3.4.

The selected overcurrent time characteristics can be superimposed by a high-set instantaneous or definite time delayed stage. Additionally, a very high set instantaneous phase current stage $I_{>>>}$ is available.

The characteristics can be individually set for phase currents and for earth currents. All stages are independent from each other and can be set individually.

The pick-up thresholds can be switched over dynamically via a binary input even during pick-up of the protection.

Under conditions of manual closing onto fault, the time overcurrent protection can also provide a rapid trip. A choice can be made whether the $I_{>>}$ stages or the $I_{>}/I_p$ stages are decisive for an undelayed trip, i.e. the associated time delay is by-passed for this condition.

4.2.1 Formation of the measured quantities

The measured currents are fed to the relay via the input transducers for each phase. The inputs are galvanically isolated against the electronic circuits as well as against each other. Thus, the star-point of the three phase currents can be formed outside of the relay, or further protection or supervision devices can be included in the current transformer circuits. For the earth current input, either the residual current of the phase current transformers can be used, or a separate summation current transformer can be connected.

The secondary sides of the relay input transformers are terminated by shunt resistors which transform the currents to proportional voltages; these voltages are converted to numerical values by analog-to-digital converters.

4.2.2 Definite time overcurrent protection

Each phase current is compared with the limit value which is set in common for the three phases. Pick-up is indicated for each phase. The phase dedicated timer is started. After the time has elapsed trip signal is given. The protection contains three stages: The $I_{>}$ stage is delayed with $T-I_{>}$, the high-set stage $I_{>>}$ is delayed with $T-I_{>>}$; the very high threshold stage $I_{>>>}$ is always instantaneous.

The residual (earth) current is processed separately and compared with separate overcurrent stages $I_{E>}$ and $I_{E>>}$. Pick-up is indicated. After the associated time $T-I_{E>}$ or $T-I_{E>>}$ has elapsed, trip command is given.

The pick-up values of each stage $I_{>}$ (phases), $I_{E>}$ (earth), $I_{>>}$ and $I_{>>>}$ (phases) and $I_{E>>}$ (earth) as well as the associated time delays can be set individually.

The logic diagram of the very high and high set stages is shown in Figure 4.2, that of the definite time overcurrent stages is shown in Figure 4.3.

4.2.3 Inverse time overcurrent protection

Each phase current is compared with the limit value which is set in common for the three phases. Pick-up is indicated for each phase. Following pick-up of the inverse time stage I_p , the trip time delay is calculated from the set inverse time characteristic and the magnitude of the fault current. After the time has elapsed trip signal is given. For the residual (earth) current a different characteristic can be selected.

The pick-up values of each stage I_p (phases), I_{Ep} (earth), $I_{>>}$ (phases) and $I_{E>>}$ (earth) as well as the associated time factors can be set individually.

The logic diagram of the inverse time overcurrent protection is shown in Figure 4.4.

For inverse time overcurrent protection stages, one can select whether the fundamental wave of the currents or the true r.m.s. values be processed.

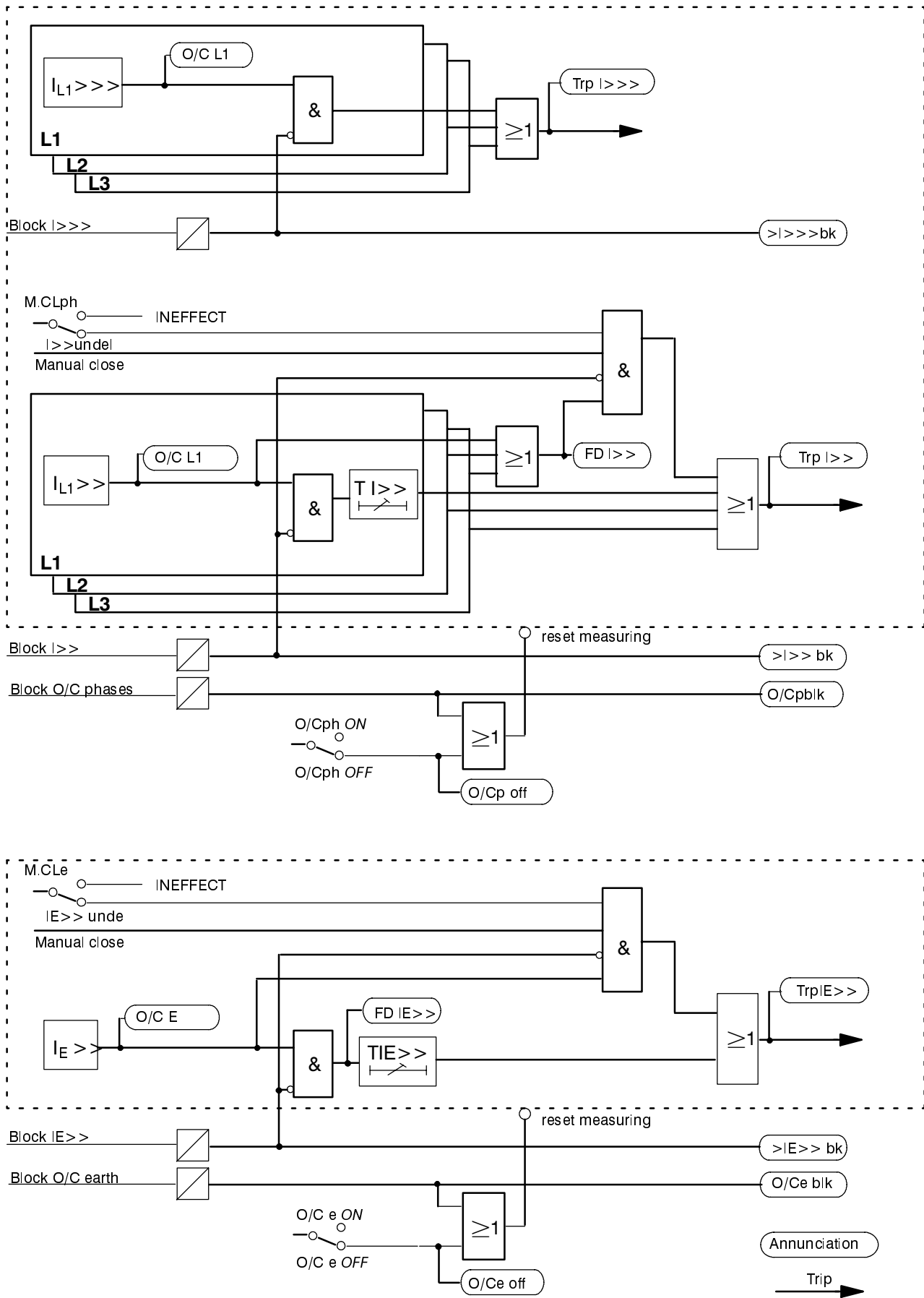

Figure 4.2 Logic diagram of the high-current stage $I >>>$ and very high stage $I >>>$ (phase currents) and $I_E >>>$ (earth current)

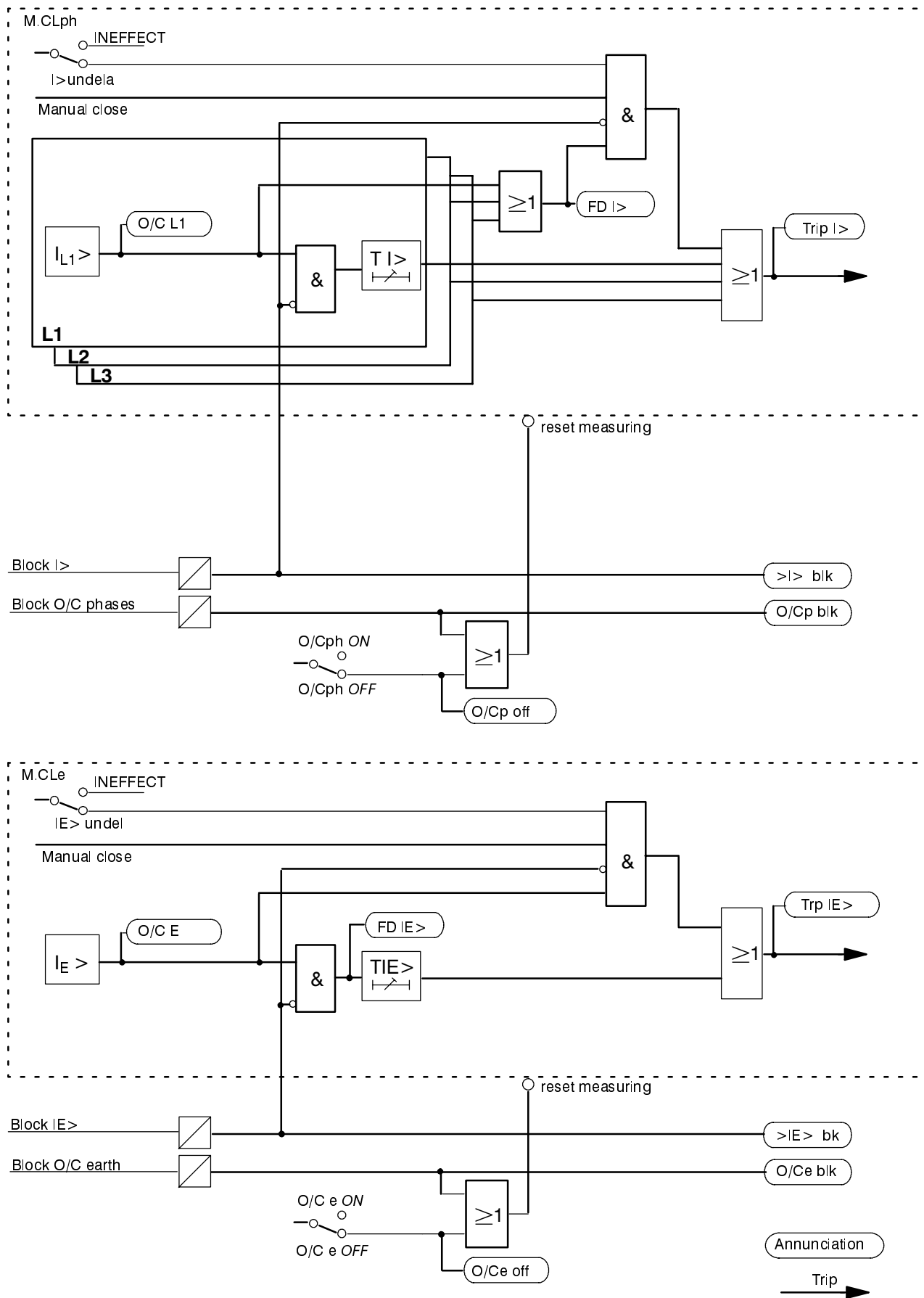

Figure 4.3 Logic diagram of the definite time overcurrent protection stages

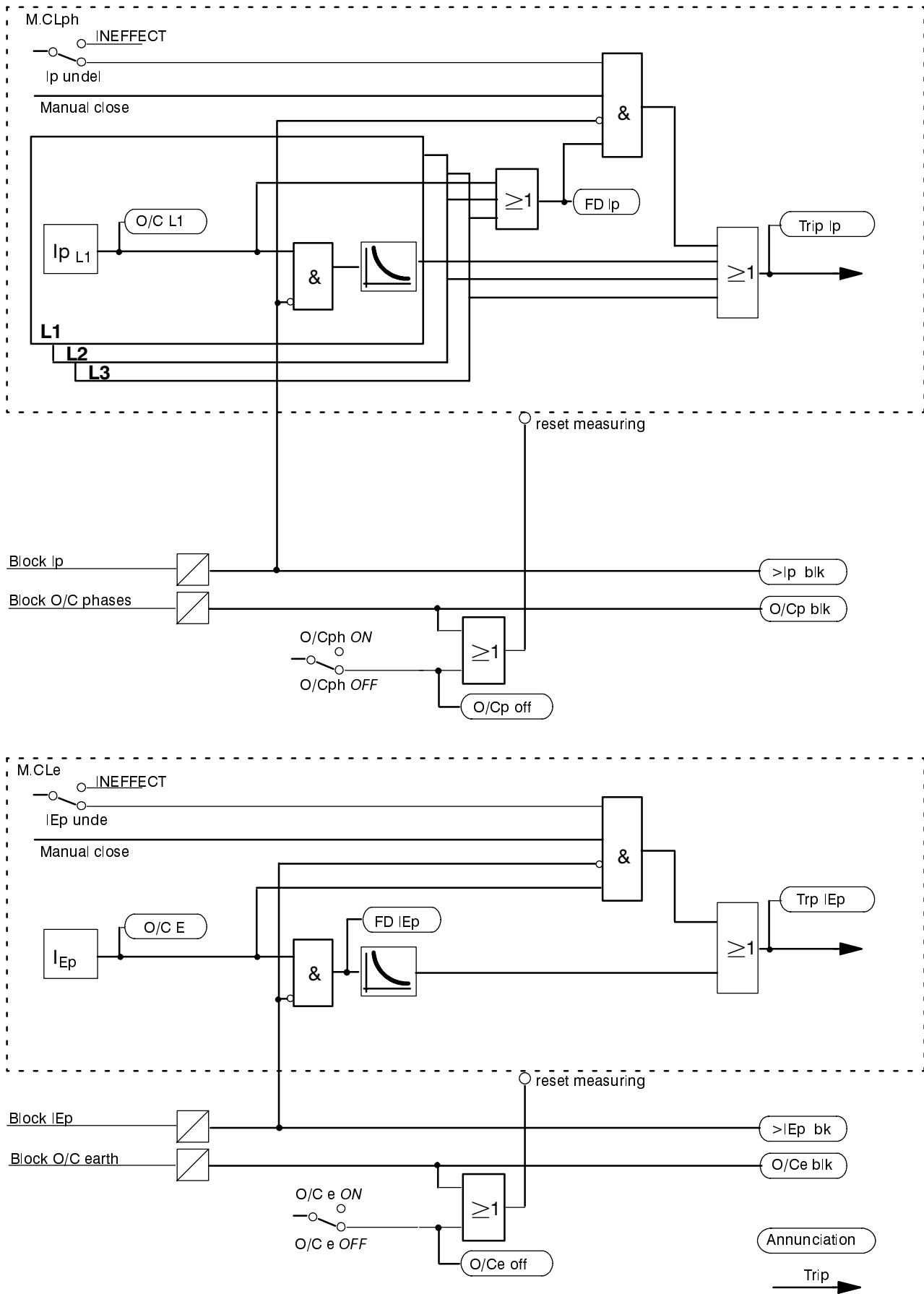

Figure 4.4 Logic diagram of the inverse time overcurrent protection stages

4.2.4 Fast bus-bar protection using reverse interlocking scheme

Each of the overcurrent stages can be blocked via binary inputs of the relay. A setting parameter determines whether the binary input operates in the "normally open" (i.e. energize input to block) or the "normally closed" (i.e. energize input to release) mode. Thus, the time overcurrent protection can be used as fast busbar protection in star connected networks or in open ring networks (ring open at one location), using the "reverse interlock" principle. This is used in high voltage systems, in power station auxiliary supply networks, etc., in which cases a transformer feeds from the higher voltage system

onto a busbar with several outgoing feeders (refer Figure 4.5).

"Reverse interlocking" means, that the time overcurrent protection can trip within a short time $T-I>>$, which is independent of the grading time, if it is not blocked by pick-up of one of the next downstream time overcurrent relays (Figure 4.5). Therefore, the protection which is closest to the fault will always trip within a short time, as it cannot be blocked by a relay behind the fault location. The time stages $I>$ or I_p operate as delayed back-up stages.

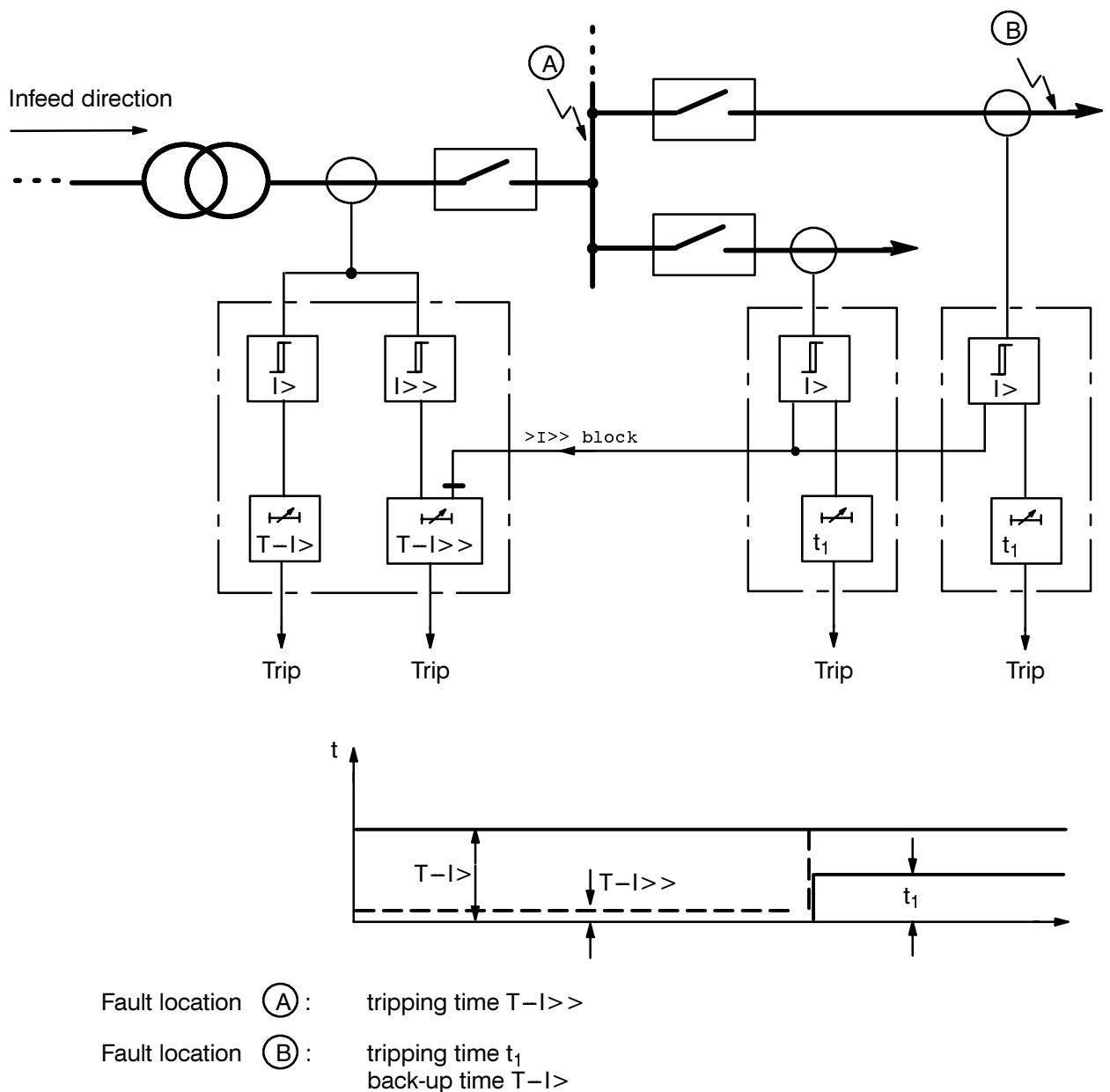

Figure 4.5 Busbar protection using reverse interlocking principle – scheme

4.3 Unbalanced load protection

The unit is equipped with an unbalanced load protection, which is advantageous for protection of motors which are switched by vacuum contactors with associated fuses. When running on single phase the motors develop small and pulsating torques, so that with unchanged torque load the motor will be quickly thermally overloaded. Furthermore, thermal overloading of the motor can arise by unsymmetrical system voltage. Even small unbalanced system voltages may lead to large slip load currents because of the small negative sequence reactances.

The unbalanced load protection detects, additionally, interruptions, short-circuits, and swapped phase connections of the current transformer circuits.

Single-phase and two-phase short-circuits can be detected even when the fault current is too small to be detected by the time overcurrent protection.

In the unbalanced load protection of the 7SJ602, the fundamental wave of the phase currents is filtered out and separated into symmetrical components (negative sequence I_2 and positive sequence I_1). The ratio I_2/I_N (I_N = rated relay current) is evaluated for unbalanced load detection.

The unbalanced load protection has two-stage design. If the first adjustable threshold $I_{2>}$ is reached, timer $T_{I_{2>}}$ is started, the second adjustable threshold $I_{2>>}$ starts the timer $T_{I_{2>>}}$ (see Figure 4.6). When the associated time has elapsed, trip command is issued.

Filtering of the negative sequence current is possible as long as the highest of the three phase currents is at least 0.1 times rated current of the relay.

Figure 4.7 shows the logic diagram of the unbalanced load protection.

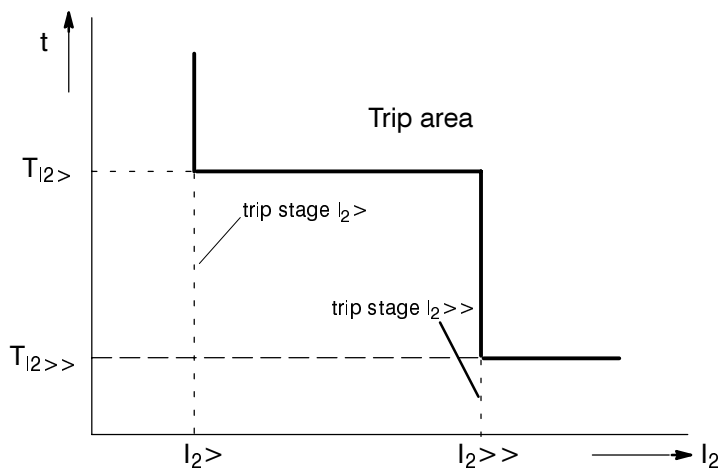

Figure 4.6 Trip time characteristic of the unbalanced load protection

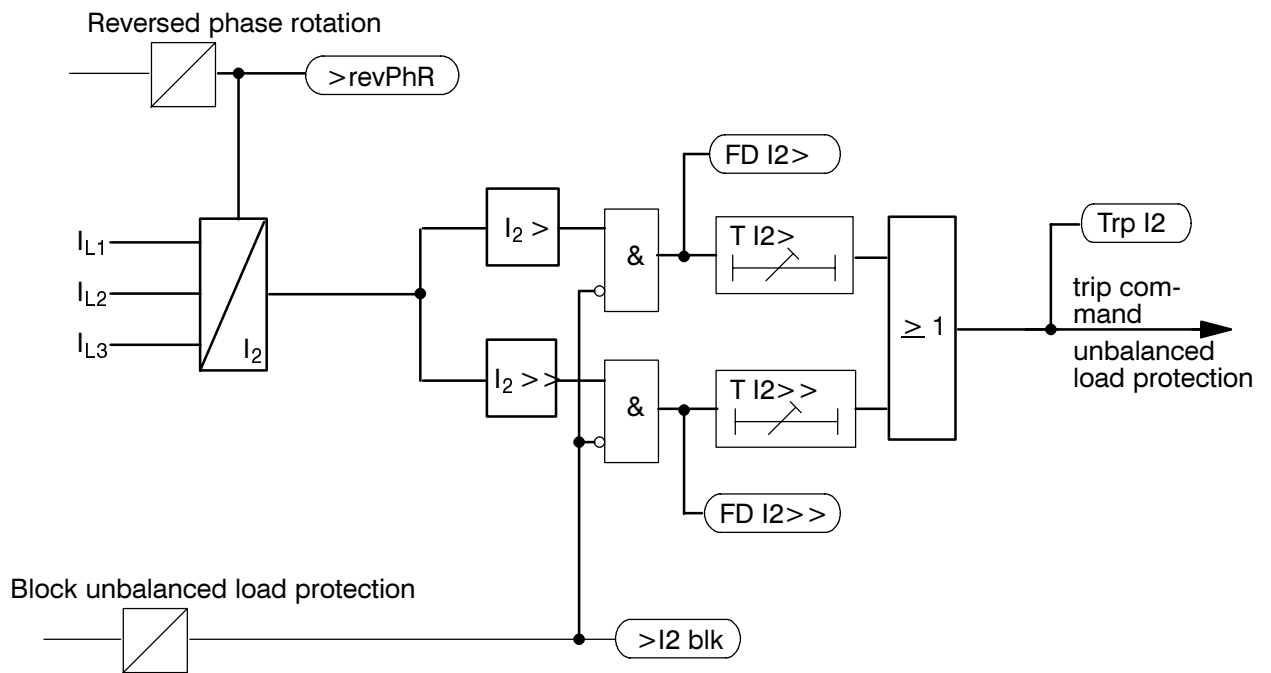

Figure 4.7 Logic diagram of the unbalanced load protection

4.4 Thermal overload protection

The thermal overload protection prevents the protected object, e.g. in case of cables or motors, from damage caused by thermal overloading. This protection operates independent on the time overcurrent and unbalanced load protection.

The protection can be optionally set to evaluate all load currents even when overload is not yet present (thermal overload protection with total memory) or to evaluate only the load currents when an adjustable overload threshold has been exceeded (overload protection without memory).

4.4.1 Overload protection with total memory

The unit computes the temperature rise according to a thermal single-body model as per the following thermal differential equation:

$$\frac{d\Theta}{dt} + \frac{1}{\tau_{th}} \cdot \Theta = \frac{1}{\tau_{th}} \cdot I^2$$

with Θ – actual temperature rise related on the final temperature rise for the maximum permissible current $k \cdot I_N$

τ_{th} – thermal time constant for heating-up of the protected object

I – actual current (r.m.s. value) related on the maximum permissible current of the protected object $I_{max} = k \cdot I_N$

When the temperature rise reaches a first set threshold, a warning alarm is given, in order to render possible an early load reduction. If the trip temperature threshold is reached the protected object can be disconnected from the network.

The temperature rises are calculated separately for each individual phase. The maximum calculated temperature rise of the three phases is decisive for the set thresholds. A true r.m.s. value measurement is performed in order to include for the effect of harmonic content.

The maximum permissible continuous thermal overload current I_{max} is described as a multiple of the rated current I_N :

$$I_{max} = k \cdot I_N$$

where k = factor according to IEC 60255–8 or VDE 0435 part 3011

In addition to the k -value, the thermal time constant τ_{th} as well as the alarm temperature Θ_{warn} must be entered into the protection unit.

When the warning threshold Θ_{warn} has been reached, the protection computes the expected time until trip (steady-state current assumed) and makes it available in the operational measured values. The applied formula is:

$$t_{trip} = \tau_{th} \cdot \ln \frac{I^2 - \Theta}{I^2 - 1}$$

with t_{trip} – expected time until trip

Θ – actual temperature rise related on the final temperature rise for the maximum permissible current $k \cdot I_N$

τ_{th} – thermal time constant for heating-up of the protected object

I – actual current (r.m.s. value) related on the maximum permissible current of the protected object $I_{max} = k \cdot I_N$

After the overload protection has tripped, the time is calculated and indicated until the temperature rise will have been fallen below the warning temperature rise, i.e. until the protection will drop off. This is the time period before which the protected object should not be re-energized. The protection uses for this calculation the cooling-down time constant which can be set as a factor of the heating-up time constant. Thus, it is considered that, with motors with self-ventilation, the cooling-down process lasts longer because the rotor does not ventilate. In this aspect, the motor is assumed to stand still when the current consumption is less than 0.1 times rated (relay) current.

$$t_{close} = k_{\tau} \cdot \tau_{th} \cdot \ln \frac{I^2 - \Theta}{I^2 - \Theta_{warn}} \quad \text{for } I < 0.1 \cdot I_N$$

with t_{close} – time after which reclosure is permitted

I – actual current

τ_{th} – heating-up time constant

k_{τ} – prolongation factor for cooling down

Θ – actual temperature rise

Θ_{warn} – parameterized warning temperature rise

4.4.2 Overload protection without memory

If the overload protection without memory is selected, the tripping time is calculated according to the simplified formula:

$$t = \frac{35}{(I / I_L)^2 - 1} \cdot t_L \quad \text{for } I > 1.1 \cdot I_L$$

- with t – tripping time
- I – overload current
- I_L – parameterized threshold value
- t_L – parameterized time multiplier (= tripping time with 6 times the threshold value I_L)

When the current of at least one phase has exceeded the limit value ($1.1 \cdot I_L$), pick-up is indicated and the timer is started. Trip command is given after the time has elapsed.

When pick-up has occurred, the protection computes the expected time until trip (steady-state current assumed) and makes it available in the operational measured values.

Figure 4.8 shows the logic diagram of the overload protection with and without memory.

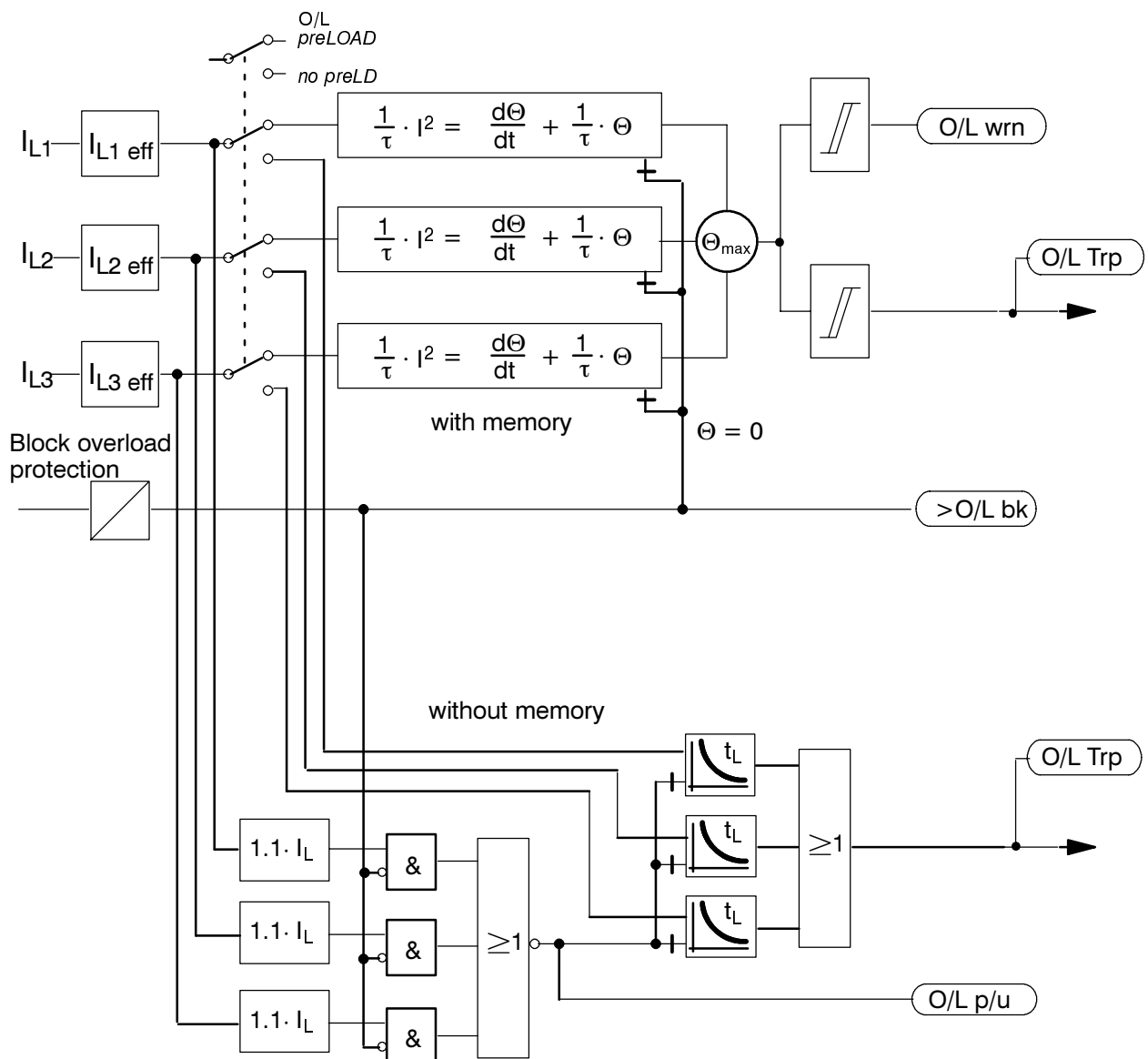

Figure 4.8 Logic diagram of overload protection

4.5 Start-up time monitoring

The start-up time monitor prevents the motor from damage caused by excessively long start-up occurrences. These may happen when, for example, the rotor is locked, the driving torque is too high, or impermissible voltage break down occurs.

The tripping time depends on the magnitude of the start-up current. The following formula is valid:

$$t = \left(\frac{I_{srt}}{I} \right)^2 \cdot t_{srt} \quad \text{for } I > I_{srt}$$

- with t – tripping time
- I – actual current (r.m.s.)
- I_{srt} – parameterized start-up current
- t_{srt} – parameterized start-up time

Figure 4.9 shows the logic diagram of the start-up time monitoring.

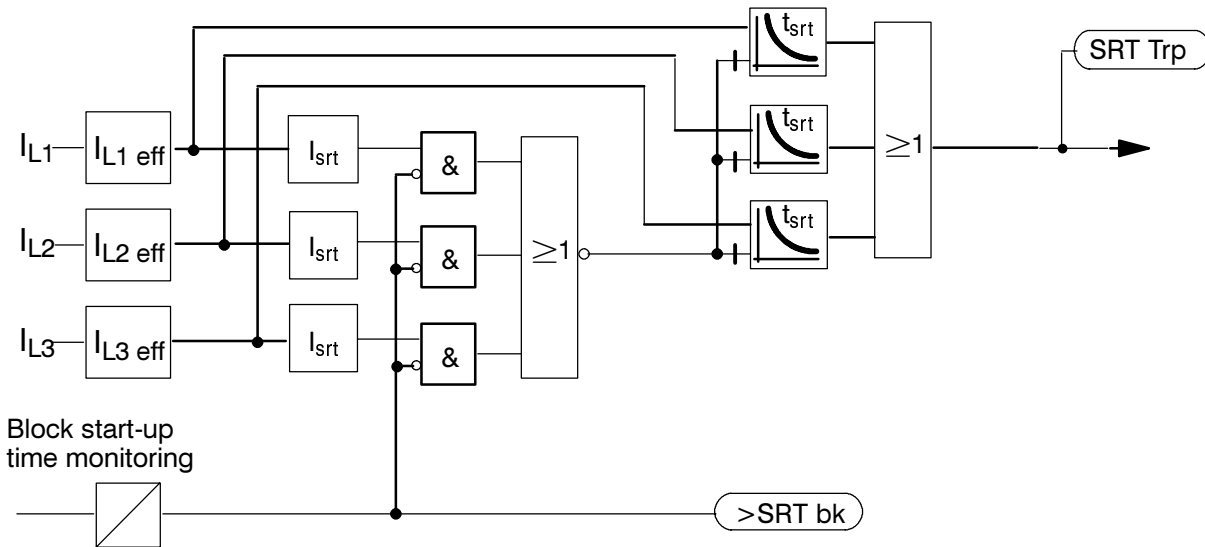

Figure 4.9 Logic diagram of start-up time monitoring

4.6 Automatic reclosure (optional)

Experience has shown that approximately 85 % of short circuits are caused by an arc, on overhead lines, and self-extinguish after interruption by the protective device. The line can therefore be re-energized. This is carried out by the automatic reclosure (AR) function.

If the short circuit is still present after the auto-reclosure (arc not quenched or metallic short circuit), then the protective relay finally disconnects the power. Multiple auto-reclosure attempts are possible in some networks.

7SJ602 allows automatic three-pole as well as single- and multi-shot reclosure.

It can be freely arranged which protection function should initiate the auto-reclosure function (refer also to Section 5.5.6). Normally, the auto-reclosure function will be started by the trip command of the short-circuit protection functions, but not by other tripping functions like overload protection or unbalanced load protection. Initiation can also be achieved from an external device via a binary input of the relay provided this input is accordingly allocated (refer also to Section 5.5.2).

For the auto-reclosure sequence to be successful, faults on any part of the line should be cleared from the feeding line ends within the same – shortest possible – time. The time overcurrent protection is, therefore, programmed as to trip with the instantaneous or short-time delayed stages $I>>$, $I>>>$, and $I_E>>$, only before the first reclosure, in order to achieve fast tripping. Thereafter, these stages are blocked in order to allow selective delayed tripping in accordance with the time-grading plan of the system.

Initiation of the auto-reclosure function can be blocked by signals which can be freely assigned to internal signals or to a binary input. This is meaningful for such tripping functions which shall block reclosure, e.g. for an external bus-bar protection. Reclosure is blocked when the blocking signal appears at any time instant while the start signal is present.

Furthermore, the reclosure command can be blocked by conditions which can equally freely arranged or input via a binary input. This blocking of reclosure operates statically, i.e. as long as it is present. But, if this blocking signal is active at the instant that reclosure command is generated, auto-reclosure is completely aborted. This can be used to en-

sure that the circuit breaker is ready to reclose and trip at the moment where reclosure command is output. Once a reclosure command is present, it is, of course, retained.

Normally, the sequence of auto-reclosure is as follows:

The time overcurrent protection clears a short-circuit in one of the rapid stages $I>>$, $I>>>$, or $I_E>>$. The AR-function is initiated. With fault clearance (i.e. drop off of the trip command), the (settable) dead time "AR T1" for the first AR-cycle commences. After the dead time, the circuit breaker receives a closing command, the duration of which is settable. Simultaneously, the (settable) reclaim time "T-REC" is started.

If the fault is cleared (successful AR), the reclaim time "T-REC" expires and all functions reset to the quiescent condition. The network fault is cleared.

If the fault has not been cleared (unsuccessful AR) then the reclaim time is aborted by the renewed trip; the next AR-cycle is initiated provided further AR-cycles are allowed. After fault clearance, the dead time "AR T_n" of the *n*-th AR-cycle starts. At the end of this, the circuit breaker is given a new closing command. Simultaneously, the reclaim time "T-REC" is re-started. Also, any fault during the reclaim time will result in initiation of the next AR-cycle if allowed.

If one of the cycles is successful, that is, after reclosure the fault is no longer present, the reclaim time "T-REC" equally runs out and all functions return to the quiescent condition. The network fault is cleared.

If none of the AR-cycles has been successful then the short-circuit protection carries out a final disconnection after the last permissible cycle. The lock-out time "T-LOC" is started. For this time the close command locked. Since no further AR cycle is permitted, AR has been unsuccessful.

A special blocking time "T-BLM" is provided for manual closing. During this time after manual closure, reclosure is blocked; any trip command will be a final trip. Precondition is that the manual close command is connected to an accordingly allocated binary input. Note that the manual close signal given to the relay does not energize the close command output but must be wired to the closing coil of the breaker by a different contact.

4.7 Trip circuit supervision

The device includes an trip circuit supervision for one trip circuit. Dependent on the number of binary inputs which are available for this purpose, supervision can be effected with one or two binary inputs. When two binary inputs are used, disturbances in the trip circuit can be detected for every switching condition; when one binary input is used, those disturbances which occur during closed trip contacts cannot be detected.

Figure 4.12 shows the logic diagram of the annunciations generated by the trip circuit supervision.

4.7.1 Supervision using two binary inputs

When two binary inputs are used, they are connected according to Figure 4.10: one input in parallel to the trip relay the circuit of which is to be supervised, the other in parallel to the circuit breaker auxiliary contact.

The binary inputs are energized (logical "H") or short-circuited (logical "L") depending on the status of the trip relay and the circuit breaker.

During normal operation it is not possible that both the binary inputs are de-energized (logical "L") at the same time unless for the short time where the trip relay has already closed but the breaker is not yet open.

If both the binary inputs are de-energized continuously, this indicates that either the trip circuit is interrupted, or the trip circuit is short-circuited, or the control voltage for tripping is absent, or the breaker has not properly operated. Thus, this status indicates a fault in the trip circuit.

The status of the two binary inputs is checked approximately every 200 ms. An intentional time delay for alarm is produced by three repeated status checks before an alarm is given. This prevents from faulty alarms due to short transient occurrences.

4.7.2 Supervision using one binary input

When one binary input is used, this is connected according to Figure 4.11: in parallel to the trip relay the circuit of which is to be supervised.

The binary input is energized (logical "H") as long as the trip relay is not energized and the trip circuit is healthy.

When the binary input is not energized (logical "L"), this indicates that either the trip contact is closed or the trip circuit is interrupted, or the trip circuit is short-circuited, or the control voltage for tripping is absent. As the trip contacts may be closed during healthy trip circuit condition, the status of the binary input is checked in relatively long periods (30 s). Furthermore, an intentional time delay for alarm is produced by three repeated status checks before an alarm is given. This prevents from faulty alarms during closed trip contacts.

Since the second binary input is not available in this mode, it must be replaced by a resistor R which is connected to the breaker auxiliary contact Aux2 (refer to Figure 4.11, compare with Figure 4.10). This allows to detect disturbance in the trip circuit even when the breaker auxiliary contact Aux1 is open and the trip contact is reset. The resistance of R is dimensioned such that the trip coil TC must not be energized when the circuit breaker is open (auxiliary contact Aux1 open, Aux 2 closed); on the other hand the binary input must be safely energized when the trip contact is open.

Information on how to dimension the resistor are contained in Section 5.2.3.

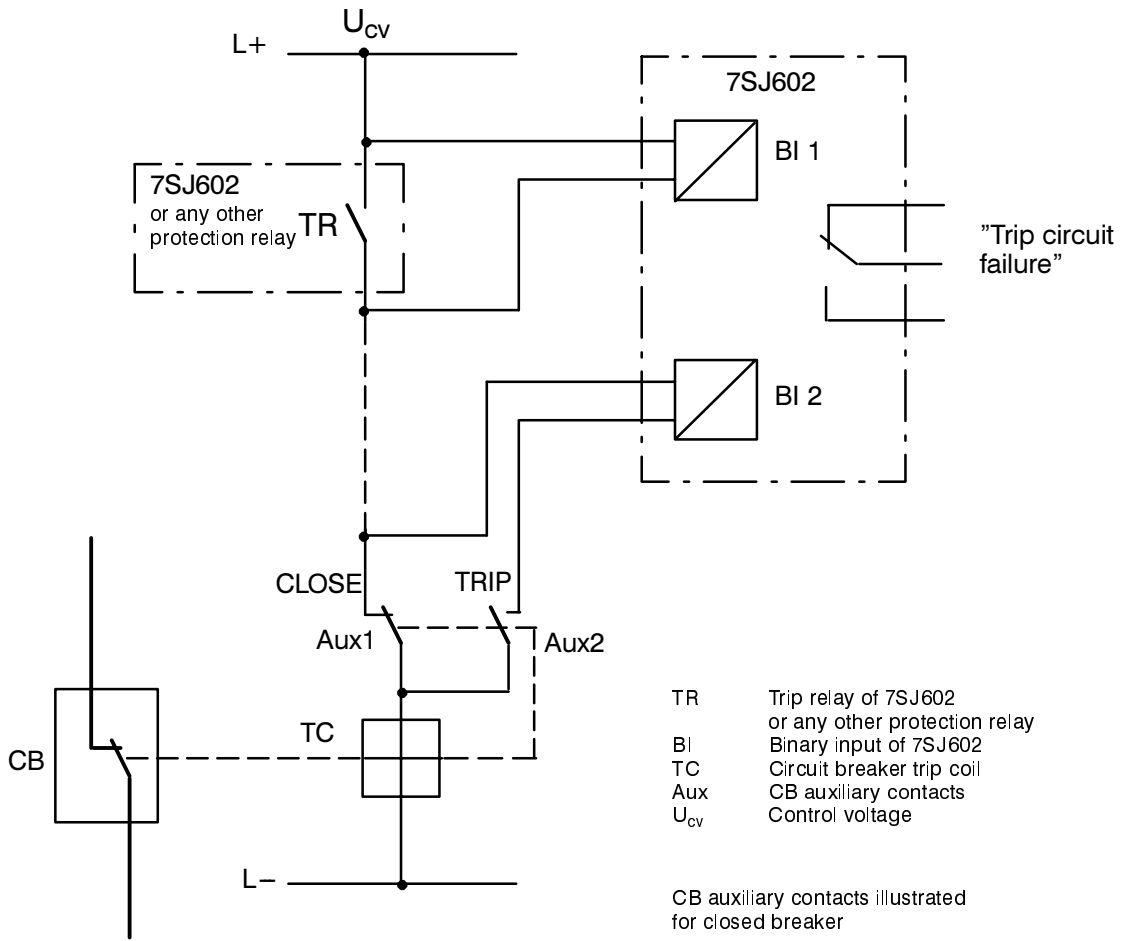

No	Trip relay	CB position	BI 1	BI 2
1	open	CLOSED	H	L
2	open	OPEN	H	H
3	closed	CLOSED	L	L
4	closed	OPEN	L	H

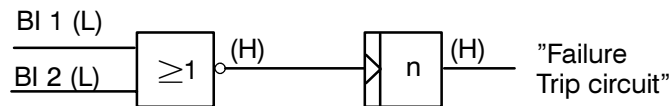

n number of repeated status checks = 3

Figure 4.10 Principle of trip circuit supervision with two binary inputs

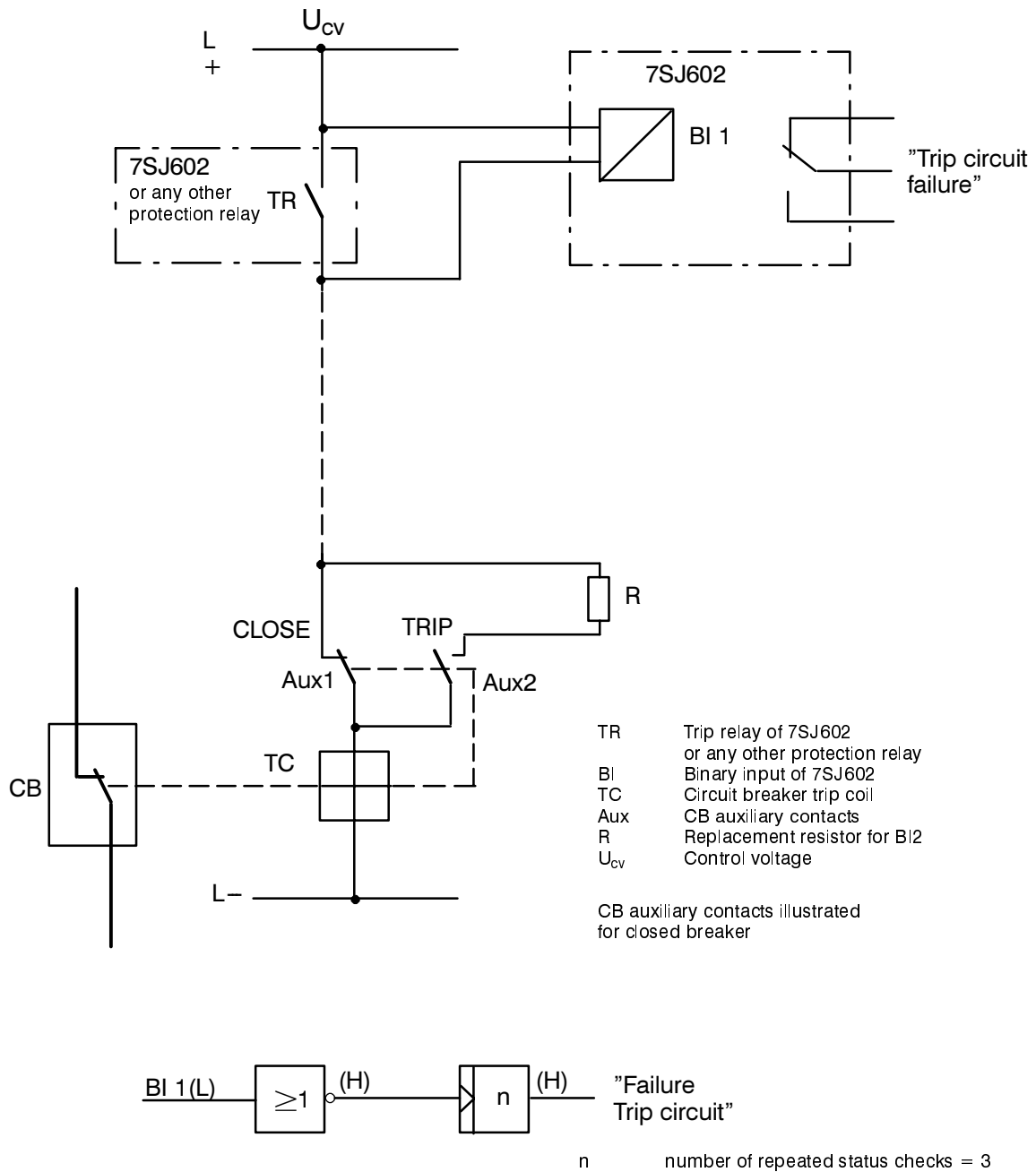

Figure 4.11 Principle of trip circuit supervision with one binary input

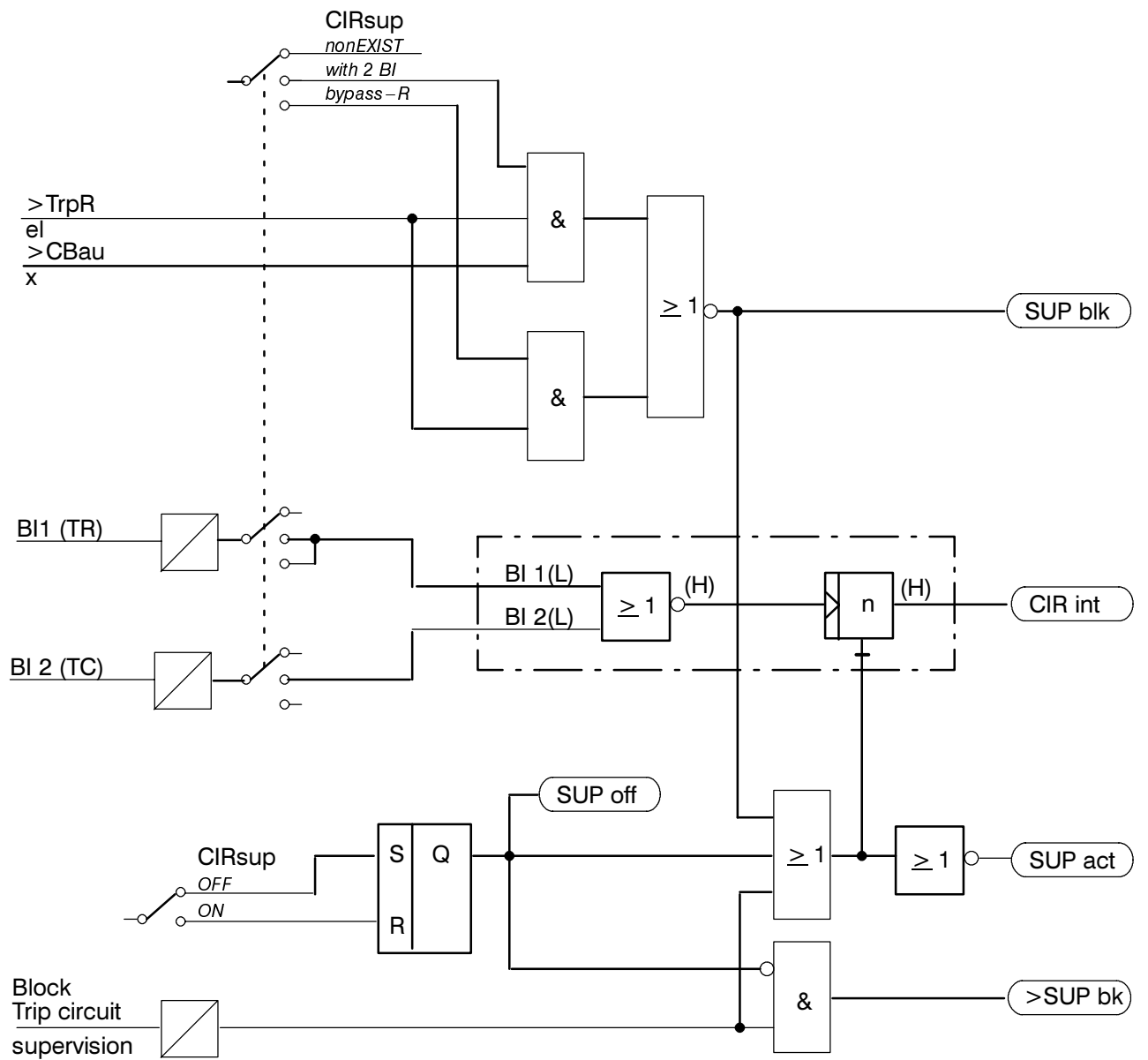

Figure 4.12 Logic diagram of trip circuit supervision

4.8 Ancillary functions

The ancillary functions of the numerical time over-current protection 7SJ602 include:

- processing of annunciations,
- storage of short-circuit data for fault recording,
- operational measurements,
- test routines,
- monitoring functions.

4.8.1 Processing of annunciations

After a fault in the protected object, information concerning the response of the protective device and knowledge of the measured values are of importance for an exact analysis of the history of the fault. For this purpose the device provides annunciation processing which is effective in three directions.

4.8.1.1 Indicators and binary outputs (signal relays)

Important events and conditions are indicated by optical indicators (LED) on the front plate. The relay also contains signal relays for remote signalling. All of the signals and indications can be marshalled, i.e. they can be allocated meanings other than the factory settings. In Section 5.5 the delivered condition and the marshalling facilities are described in detail.

The output signal relays are not latched and automatically reset as soon as the originating signal disappears. The LEDs can be arranged to latch or to be self-resetting.

The memories of the LEDs can be reset:

- locally, by operation of the reset button ("N") on the relay,
- remotely by energization of the remote reset input,
- via the operating interface,

- automatically, on occurrence of a new general pick-up signal.

Some indicators and relays indicate conditions; it is not appropriate that these should be stored. Equally they cannot be reset until the originating criterion has been removed. This mainly concerns fault indications such as "Trip circuit interrupted", etc.

A green LED indicates readiness for operation ("Service"). This LED cannot be reset and remains illuminated when the microprocessor is working correctly and the unit is not faulty. The LED extinguishes when the self-checking function of the microprocessor detects a fault or when the auxiliary voltage is absent.

With the auxiliary voltage present but with an existing internal fault in the unit, a red LED illuminates ("Blocked") and blocks the unit.

4.8.1.2 Information on the display panel or to a personal computer

Events and conditions can be read off in the display on the front plate of the device. Additionally, a personal computer, for example, can be connected via the operation interface, and all the informations can then be sent to it. The interface is suited to be operated directly or via a modem link.

In the quiescent state, i.e. as long as no network faults are present, the display outputs the operational measured values of the phase currents I_{L1} and I_{L2} . In the event of a network fault, information on the fault appears instead of the operating information. The first line of the display indicates the phase(s) in which the fault has been detected; the second line displays the trip annunciation of the time overcurrent protection. The quiescent information is displayed again once these fault annunciations have been acknowledged. The acknowledgement is identical to resetting of the stored LED displays as in Section 4.8.1.1.

The device also has several event buffers, e.g. for operating messages or fault annunciations (refer to Section 6.4). These messages, as well as the available operating values, can be transferred into the front display at any time using the keyboard or to the personal computer via the operating interface.

After a fault, for example, important information concerning its history, such as pick-up and tripping, can be called up on the display of the device. The fault inception is indicated with the absolute time of the operating system. The sequence of the events is tagged with the relative time referred to the moment at which the fault detector has picked up. Thus, the elapsed time until tripping is initiated and until the trip signal is reset can be read out. The resolution is 1 ms.

The events can also be read out with a personal computer by means of the appropriate program DIGSI®. This provides the comfort of a CRT screen and menu-guided operation. Additionally, the data can be documented on a printer or stored on a floppy disc for evaluation elsewhere.

The protection device stores the data of the last eight network faults; if a ninth fault occurs the oldest fault is overwritten in the fault memory.

A network fault begins with recognition of the fault by pick-up of any fault detector and ends with fault detector reset or expiry of the auto-reclose sequences so that non-successful auto-reclose attempts will also be stored as part of one network fault (if auto-reclosure is carried out). Thus, one network fault can include different fault events (from pick-up until drop-off). This is particularly advantageous for allocation of time data.

4.8.2 Data storage and transmission for fault recording

The instantaneous values of the measured values

$$i_{L1}, i_{L2}, i_{L3}, i_E$$

are sampled at 1 ms intervals (for 50 Hz) or 0.83 ms intervals (for 60 Hz) and stored in a circulating shift register. In case of a fault, the data are stored over a selectable time period, but max. over 5 seconds. The maximum number of fault records within this time period is 8. These data are then available for fault analysis. For each renewed fault event, the actual new fault data are stored without acknowledgement of the old data.

The fault data of the last fault are saved in the relay and protected against power supply failure.

The data can be transferred to a connected personal computer via the operation interface and evaluated by the protection data evaluation program DIGSI®. The currents are referred to their maximum values, normalized to their rated values and prepared for graphic visualization. In addition, signals are marked as binary traces, e.g. "Pick-up" and "Trip".

4.8.3 Operating measurements

For local recall or transmission of data, the true r.m.s. values of the phase currents are available as long as the relay is not dealing with a fault. When the overload protection with total memory is in operation the calculated temperature rise can be read out. When the warning threshold has been exceeded, the time to trip (steady-state current assumed), after an overload trip the time until the warning temperature rise is fallen below, can be read out.

The following is valid:

- I_{L1}, I_{L2}, I_{L3} Phase currents in % of rated current and in amps primary,
- I_E earth current in % of rated current and in amps primary,
- $\Theta/\Theta_{\text{trip}}$ calculated temperature rise referred to trip temperature rise.

4.8.4 Control functions

7SJ602 is capable of control of a circuit breaker. That means that trip and close commands can be issued to the breaker via the integrated keypad on the front of the device, or via a serial interface from a personal computer or a central control station (LSA).

Breaker control can be switched on or off by parameter setting or via a serial interface and may be blocked via a binary input.

The CLOSE command generates the annunciation "Q0 Clo." which must be allocated to the binary output for breaker close (if applicable together with the AR close command) during configuration. The annunciation "DEV Cls" is also generated as the common close annunciation of the device.

The annunciation remains until the general close command duration T-CL has expired. The close command is disrupted as soon as a trip command occurs.

The TRIP command generates the annunciation "Q0 Trp" which must be allocated to the binary output for breaker trip (together with the protection trip signal(s)) during configuration. The annunciation "DEV Trp" is also generated as the common trip annunciation of the device.

The annunciation remains until the general trip command duration T-TRP has expired. The close command of this control function does not initiate the auto-reclose function (if available).

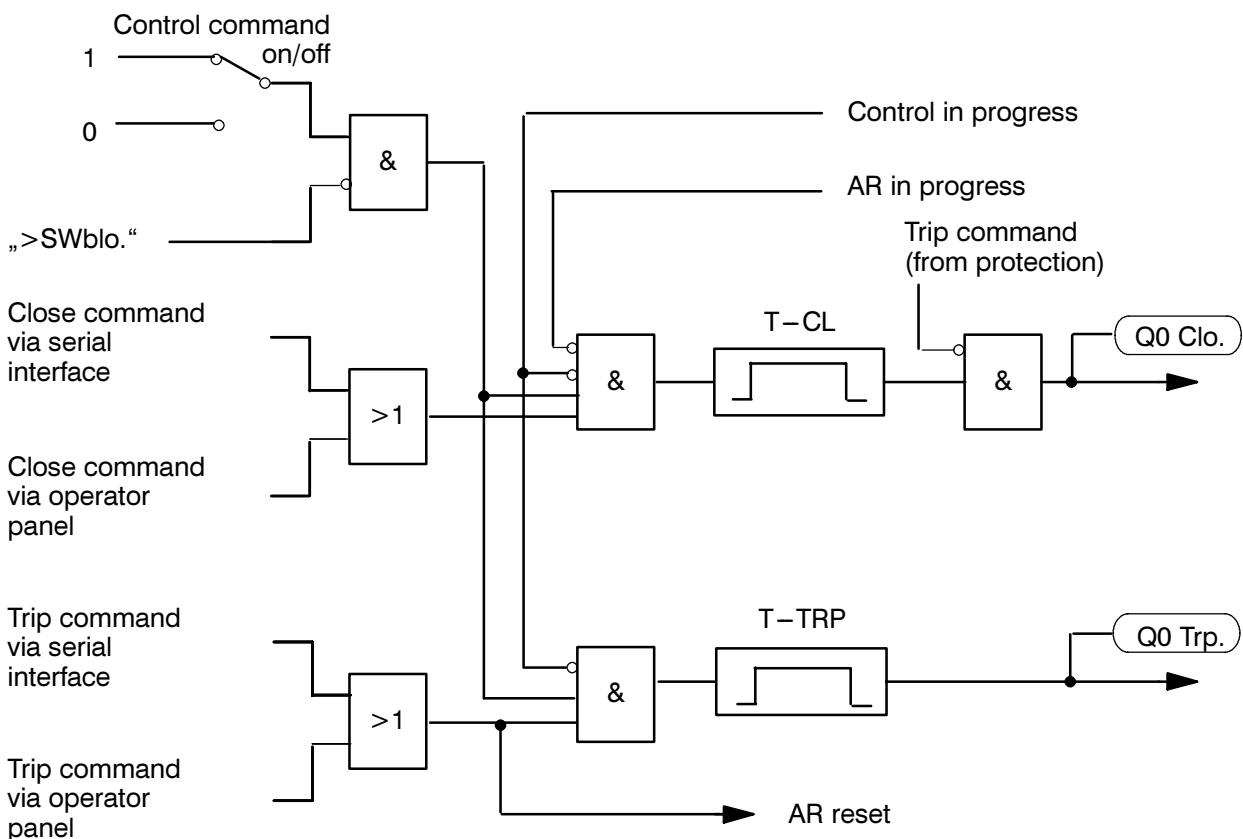

Figure 4.13 Logic of circuit breaker control

4.8.5 Test facilities

Numerical time overcurrent protection 7SJ602 allows simple checking of the tripping circuit and the circuit breaker as well as interrogation of the state of all binary inputs and outputs. Initiation of the test can be given from the operator keyboard or via the operator interface (refer to Section 6.7.3 and 6.7.4).

4.8.5.1 Circuit breaker trip test

Prerequisite for the start of a circuit breaker trip test is that no protective function has picked up.

The relay issues a three-pole trip command. Before start of the procedure and during the test procedure, the relay indicates the test sequence in the display. If the relay is equipped with the auto-reclosure option, a TRIP/RECLOSE cycle can be initiated.

4.8.5.2 Interrogation of binary states

The momentary condition of all binary inputs and binary outputs (signal relays, trip relays, LED indicators) can be displayed on request by the operator.

4.8.6 Monitoring functions

The device incorporates comprehensive monitoring functions which cover both hardware and software.

4.8.6.1 Hardware monitoring

The complete hardware is monitored for faults and inadmissible functions, from the measured value inputs to the output relays. In detail this is accomplished by monitoring:

– Auxiliary and reference voltages

Failure or switch-off of the auxiliary voltage automatically puts the system out of operation; this status is indicated by the breaking contact of an availability relay provided it is accordingly allocated. Transient dips in supply voltage of less than 50 ms will not disturb the function of the relay (rated d.c. auxiliary voltage ≥ 110 V).

– Command output channels:

The command relays for tripping and reclosing are controlled by two command and one additional release channels. As long as no pick-up condition exists, the central processor makes a cyclic check of these command output channels for availability, by exciting each channels one after the other and checking for change in the output signal level. Change of the feed-back signal to low level indicates a fault in one of the control channels or in the relay coil. Such a condition leads automatically to alarm and blocking of the command output.

– Memory modules:

After the relay has been connected to the auxiliary supply voltage, the working memory (RAM) is checked by writing a data bit pattern and reading it.

The further memory modules are periodically checked for fault by

- formation of the modulus for the program memory (EPROM) and comparison of it with a reference program modulus stored there,
- Formation of the modulus of the values stored in the parameter store (EEPROM) then comparing it with the newly determined modulus after each parameter assignment process.

4.8.6.2 Software monitoring

For continuous monitoring of the program sequences, a watchdog timer is provided which will reset the processor in the event of processor failure or if a program falls out of step. Further, internal plausibility checks ensure that any fault in processing of the programs, caused by interference, will be recognized. Such faults lead to reset and restart of the processor.

If such a fault is not eliminated by restarting, further restarts are initiated. If the fault is still present after three restart attempts the protective system will switch itself out of service and indicate this condition by drop-off of the availability signal, thus indicating "equipment fault" and simultaneously the LED "Blocked" comes on.

4.8.6.3 Measured value supervision

In the current path, there are four input converters; the digitized sum of the outputs of these must always be zero. A fault in the current path is recognized when

$$|i_{L1} + i_{L2} + i_{L3} + k_I \times i_E| > \text{SUM.Th} \times I_N + \text{SUM.Fa} \times I_{\max}$$

An adjustable factor k_I (parameter I_e/I_{ph}) can be set to correct the different ratios of phase and earth current transformers (e.g. summation transformer for earth fault detection). If the residual earth current is derived from the current transformer starpoint, $k_I = 1$. SUM.Th and SUM.Fa are setting parameters (see Section 6.3.9). The component $\text{SUM.Fa} \times I_{\max}$ takes into account permissible current proportional transformation errors in the input converters which may particularly occur under conditions of high short circuit currents (Figure 4.14).

Note: Current sum monitoring can operate properly only when the residual current of the protected line is fed to the I_E input of the relay.

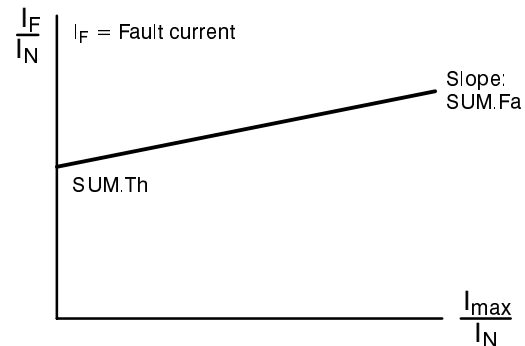

Figure 4.14 Current sum monitoring (current plausibility check)

5 Installation instructions



Warning

The successful and safe operation of this device is dependent on proper handling and installation by qualified personnel under observance of all warnings and hints contained in this manual.

In particular the general erection and safety regulations (e.g. IEC, DIN, VDE, or national standards) regarding the correct use of hoisting gear must be observed. Non-observance can result in death, personal injury or substantial property damage.

5.1 Unpacking and repacking

When dispatched from the factory, the equipment is packed in accordance with the guidelines laid down in IEC 60255–21, which specifies the impact resistance of packaging.

This packing shall be removed with care, without force and without the use of inappropriate tools. The equipment should be visually checked to ensure that there are no external traces of damage.

The transport packing can be re-used for further transport when applied in the same way. The storage packing of the individual relays is not suited to transport. If alternative packing is used, this must also provide the same degree of protection against mechanical shock, as laid down in IEC 60255–21–1 class 2 and IEC 60255–21–2 class 1.

Before initial energization with supply voltage, the relay shall be situated in the operating area for at least two hours in order to ensure temperature equalization and to avoid humidity influences and condensation.

5.2 Preparations

The operating conditions must accord with VDE 0100/5.73 and VDE 0105 part 1/7.83, or corresponding national standards for electrical power installations.



Caution!

The modules of digital relays contain CMOS circuits. These shall not be withdrawn or inserted under live conditions! The modules must be so handled that any possibility of damage due to static electrical charges is excluded. During any necessary handling of individual modules the recommendations relating to the handling of electrostatically endangered components (EEC) must be observed.

In installed conditions, the modules are in no danger.

5.2.1 Mounting and connections

5.2.1.1 Model 7SJ602*-★B*** for panel surface mounting

- Secure the unit with four screws to the panel. For dimensions refer to Figure 2.1.
- Connect the earthing screw of the device with the earthing system of the panel. The cross-section of the earthing wire must be greater than or equal to the cross-section of any other control conductor connected to the device, but at least 2.5 mm².
- Make connections via the screwed terminals; observe labelling of the individual terminals; observe the maximum permissible cross-sections and torque (see Section 2.3). Use copper conductors only!
- If an electrical interface is used, the cable screen must be earthed. If an optical interface is used, observe the permissible bending radius (Section 2.3).

5.2.1.2 Model 7SJ602*-★D*** and -★E*** for panel flush mounting or cubicle installation

- Slip away the covers at top and bottom of the housing in order to gain access to the four holes in the fixing angle.
- Insert the unit into the panel cut-out or the cubicle rack and secure it with four fixing screws. For dimensions refer to Figure 2.2.
- Replace the covers.
- Make a solid low-ohmic and low-inductive operational earth connection between the earthing surface at the rear of the unit using at least one standard screw M4, and the earthing system of the panel or cubicle. The cross-section of the earthing wire must be greater than or equal to the cross-

section of any other control conductor connected to the device, but at least 2.5 mm².

- Make connections via the screwed or snap-in terminals of the connectors of the housing. Observe labelling of the individual connector modules to ensure correct location; observe the max. permissible conductor cross-sections and torque (see Section 2.3). Use copper conductors only!
- If an electrical interface is used, the cable screen must be earthed. If an optical interface is used, observe the permissible bending radius (Section 2.3).
- Earth the screen of the serial RS485 interface when it is used.

5.2.2 Checking the rated data

The rated data of the unit must be checked against the plant data. This applies in particular to the auxiliary voltage and the rated current of the current transformers.

5.2.2.1 Auxiliary voltage

Four different ranges of auxiliary voltage can be delivered (cf. Section 2.4 and 3.1). If, for exceptional reason, the rated voltage of the supply input is to be changed, it must be taken into account that the models for rated auxiliary voltage 48/60/110/125 Vdc and 110/125/220/250 Vdc differ from each other by different plug jumpers. The assignment of these jumpers is shown in Table 5.1, their location on the p.c.b. in Figure 5.1. The model for 110/125/220/250 Vdc is suitable for 115 Vac, too. A different model is suited for 230 Vac. When the relay is delivered, all these plugs are correctly located and matched to the specification given on the name plate of the relay, so that, normally, none of the bridges need to be altered.

Jumpers	24 Vdc	48/60/110/125 Vdc	110/220/250 Vdc; 115 Vac	230 Vac
X51	none	1–2	2–3	none
X52	none	1–2, 3–4	2–3	none
X53	none	1–2	2–3	none

Table 5.1 Jumper position for auxiliary voltage

5.2.2.2 Rated currents

The current inputs of the relay are matched to the rated current as given on the name plate of the relay according to the order designation. The rated current is considered by correct location of plug jumpers on the p.c.b. The assignment of these jumpers is shown in Table 5.2 and their location on the p.c.b. is shown in Figure 5.1. When the relay is delivered, all these plugs are correctly located and matched to the specification given on the name plate of the relay, so that, normally, none of the bridges need to be altered.

Jumper	$I_N = 1 \text{ A}$	$I_N = 5 \text{ A}$
X21 to X24	1A	5A

Table 5.2 Jumper position for rated currents

5.2.2.3 Control d.c. voltage of binary inputs

When the device is delivered from the factory, the binary inputs are set to operate with a dc control voltage that corresponds to the rated dc voltage of the power supply. In general, to optimize the operation of the inputs, the pick-up voltage of the inputs should be set to most closely match the actual control voltage being used. Each binary input has a pick-up voltage that can be independently adjusted; therefore, each input can be set according to the function performed.

A jumper position is changed to adjust the pick-up voltage of a binary input. Table 5.3 shows the assignment of these jumpers, Figure 5.1 their location on the p.c.b.

Jumper	Rated control voltage 24/48/60/110/ 125 V– Pick-up threshold 19 V	Rated control voltage 110/220/250 V– 115/230 V~ Pick-up threshold 88 V
X11 to X13	L	H

Table 5.3 Jumper position for the rated control voltages of binary inputs

Note: If binary inputs are used for trip circuit supervision, it must be considered that two binary inputs (or one input and a replacement resistor) are connected in series. Therefore, the pick-up threshold must be clearly smaller than half the control voltage.

5.2.2.4 Contact mode of the “Life status” contact

The contact of the life status supervision relay can be operated in normally open (NO) or normally closed (NC) mode. Normally, the NC mode is used but the contact mode can be changed according to Table 5.4.

Jumper	NO contact	NC contact	as delivered
X15	1–2	2–3	2–3

Table 5.4 Jumper position for the contact mode of the life status contact

5.2.2.5 Performing alterations of the jumpers

- Slip away the covers at top and bottom of the housing in order to gain access to the two fixing screws of the module. Unscrew these screws.
- If the device has a communication interface at the bottom, the six screws of the communication module must be loosened and the module must be removed.
- Pull out the module by taking it at the front cover and place it on a surface which is suited to electrostatically endangered components (EEC).



Caution!

Electrostatic discharges via the component connections, the PCB tracks or the connecting pins of the modules must be avoided under all circumstances by previously touching an earthed metal surface.

- Check the solder bridges according to Figure 5.1.
- Insert module into the housing;
- Fix the module into the housing by tightening the two fixing screws.
- If the device has a communication interface, the communication module must be re-inserted and fixed.
- Re-insert covers.

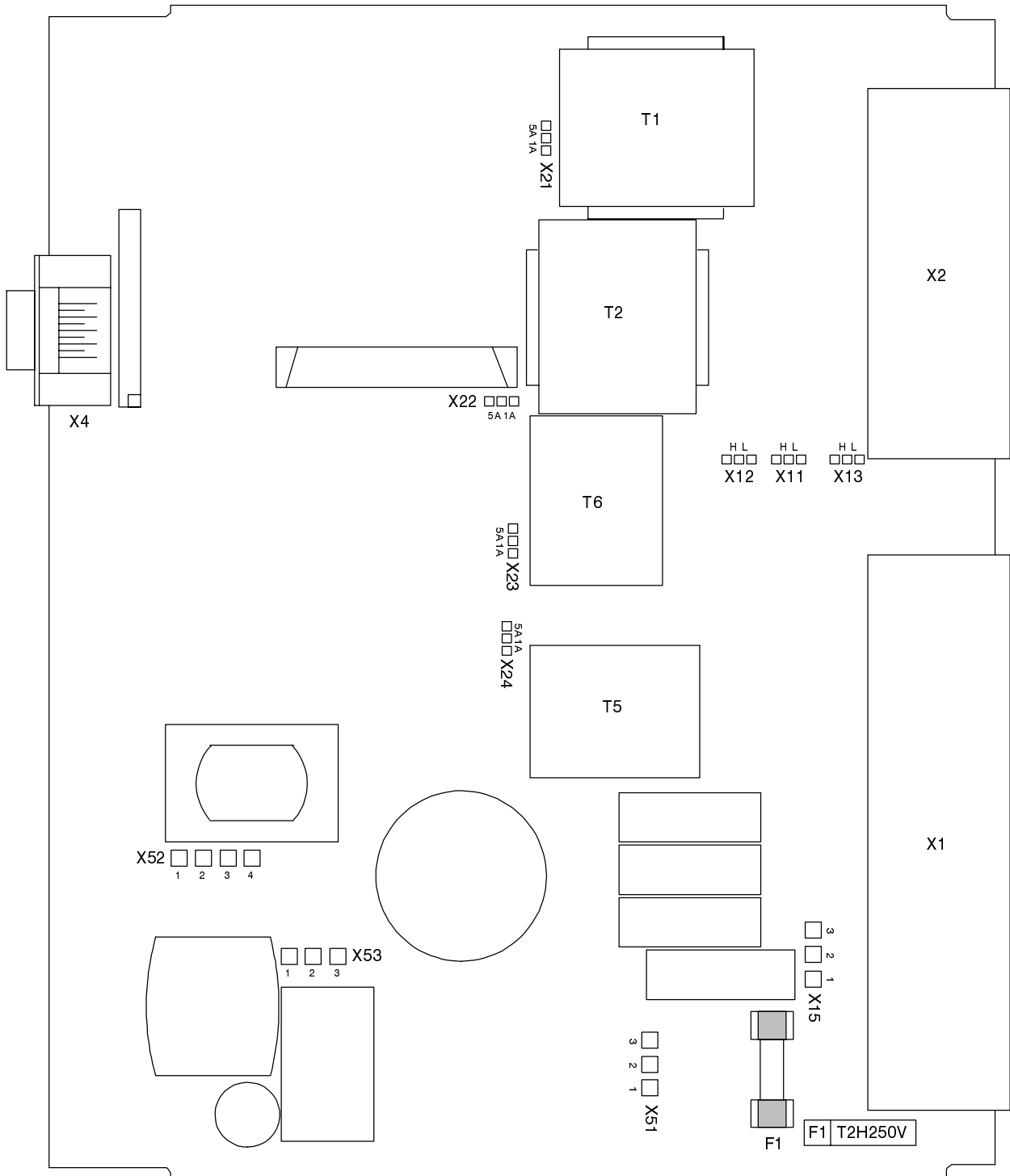

Figure 5.1 CPU-module – illustration of the jumpers on the printed circuit board

5.2.3 Connections

General and connection diagrams are shown in Appendix A and B. The marshalling possibilities of the binary inputs and outputs are described in Section 5.5.

If the trip circuit supervision is used, decision must be made whether two binary inputs or only one is available for this purpose. The function is explained in detail in Section 4.7, where also the principle connections are given.

Note: It must be considered that two binary inputs (or one input and a replacement resistor) are connected in series. Therefore, the pick-up threshold of the binary input(s) (Section 5.2.2.3) must be clearly smaller than half the control voltage.

If one single binary input is available (Figure 5.2), an external resistor R must be connected in the circuit of the breaker auxiliary contact (Aux2), which replaces the missing second binary input (refer also to Section 4.7.2). Thus, a fault is also detected when the NO auxiliary contact is open and the trip relay

contact has reset. This resistor must be dimensioned such that the trip coil (TC) of the breaker cannot operate when the breaker is open (Aux1 open and Aux2 closed), but that the binary input (BI1) can operate when the trip contact of the device has opened, at the same time (Figure 5.4).

This results in an upper limit R_{max} and a lower limit R_{min} of the resistance, from which the arithmetical mean value is taken:

$$R = \frac{R_{max} + R_{min}}{2}$$

The maximum resistance R_{max} is derived from the minimum control voltage of the binary input:

$$R_{max} = \frac{U_{CV} - U_{BI\ min}}{I_{BI\ (High)}} - R_{TC}$$

The minimum resistance R_{min} is derived from the maximum control voltage which does not operate the circuit breaker trip coil:

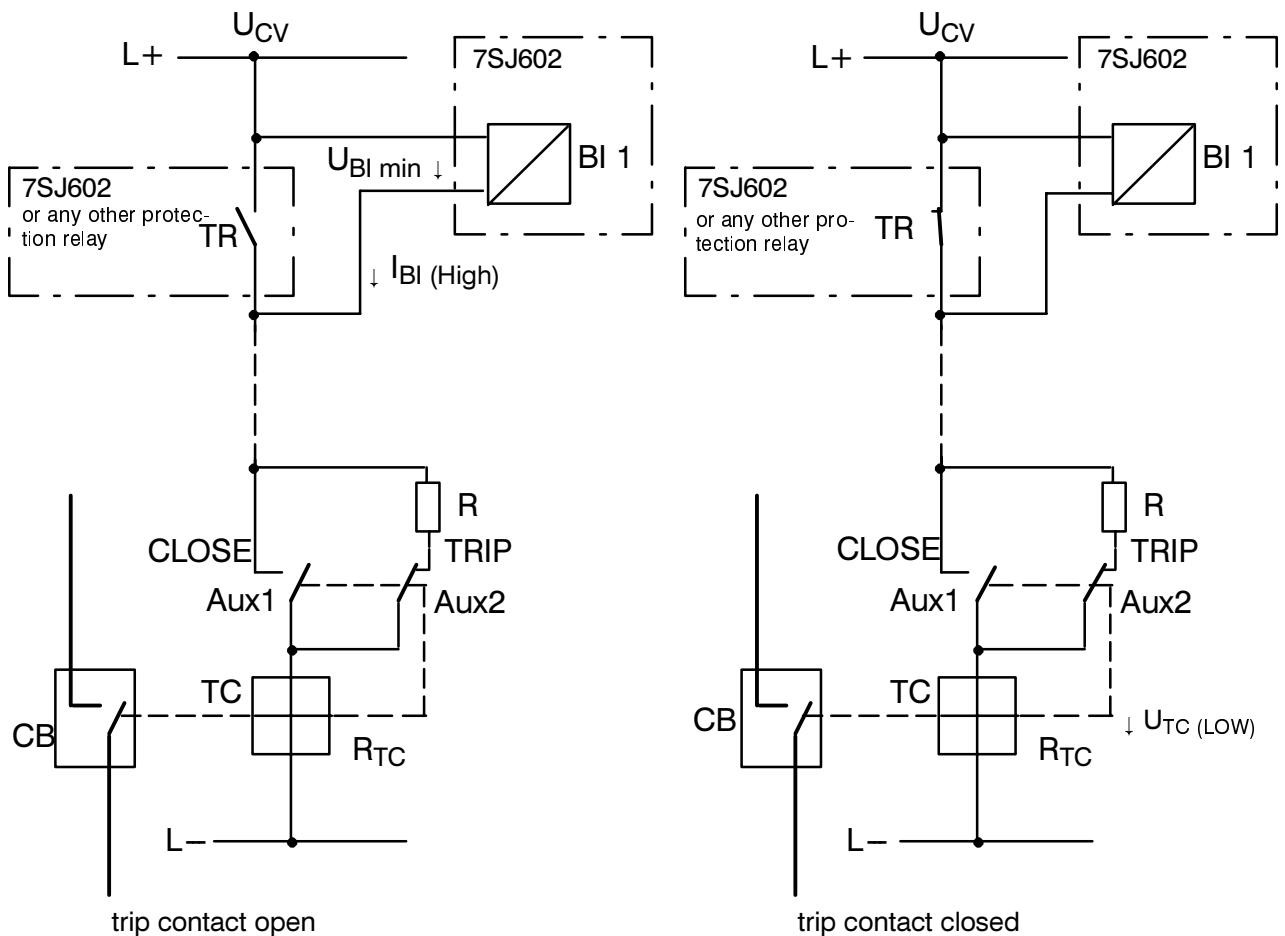

Figure 5.2 Dimensioning the external resistor R when one single binary input is used

$$R_{\min} = R_{TC} \cdot \frac{U_{CV} - U_{TC(Low)}}{U_{TC(Low)}}$$

$I_{BI(High)}$ constant current which operates the binary input (approx. 2 mA)

$U_{BI\ min}$ minimum control voltage for the binary input (approx. 17 V at delivery, approx. 75 V with increased pick-up)

U_{CV} Control voltage of the trip circuit

R_{TC} ohmic resistance of the trip coil

$U_{TC(Low)}$ maximum voltage which does not operate the trip coil

Example:

$I_{BI(High)}$ 1.6 mA (protection relay data)

$U_{BI\ min}$ 17 V (protection relay data)

U_{CV} 110 V (switchgear control voltage)

R_{TC} 500 Ω (circuit breaker data)

$U_{TC(Low)}$ 2 V (circuit breaker data)

$$R_{\max} = \frac{110\ V - 17\ V}{1.6\ mA} - 500\ \Omega$$

$$R_{\max} = 46\ k\Omega$$

$$R_{\min} = 500\ \Omega \cdot \frac{110\ V - 2\ V}{2\ V}$$

$$R_{\min} = 27\ k\Omega$$

$$R = \frac{R_{\max} + R_{\min}}{2} = 36.5\ k\Omega$$

The nearest standard value is selected: 33 k Ω .

5.2.4 Checking the connections



Warning

Some of the following test steps are carried out in presence of hazardous voltages. They shall be performed by qualified personnel only which is thoroughly familiar with all safety regulations and precautionary measures and pay due attention to them.

Non-observance can result in severe personal injury.

Before initial energization with supply voltage, the relay shall be situated in the operating area for at least two hours in order to ensure temperature equalization and to avoid humidity influences and condensation.

– Switch off the circuit breakers for the d.c. supply!

– Check the continuity of all the current transformer circuits against the plant and connection diagrams:

- Are the current transformers correctly earthed?

- Is the phase relationship of the current transformers correct?

- Are the polarities of the current transformer connections consistent?

If test switches have been fitted in the secondary circuits, check their function, particularly that in the "test" position the current transformer secondary circuits are automatically short-circuited.

– Fit an ammeter in the auxiliary power circuit; range approx. 1.5 A to 3 A.

– Close the power supply circuit breaker; check polarity and magnitude of voltage at the terminals of the unit or at the connector module.

– The measured current consumption should correspond to the quiescent power consumption of approximately 2 W/VA. Transient movement of the ammeter pointer only indicates the charging current of the storage capacitors.

– Open the circuit breaker for the power supply.

– Remove the ammeter; reconnect the auxiliary voltage leads.

– Close the power supply circuit breaker. The unit starts up and, on completion of the run-up period, the green LED on the front comes on, the red LED gets off after at most 7 sec.

– Open the circuit breaker for the power supply.

– Check through the tripping circuits to the circuit breaker.

– Check through the control wiring to and from other devices.

– Check the signal circuits.







5.3 Configuration of operation and memory functions

5.3.1 Operational preconditions and general

For most operational functions, the input of a codeword is necessary. The "codeword" is a predefined key sequence which must be entered via the membrane keyboard or operating interface which concern the operation on the relay, for example

- configuration parameters for operation language, interface configuration, and device configuration,
- allocation or marshalling of annunciation signals, binary inputs, optical indications,
- setting of functional parameters (thresholds, functions).
- starting of test procedures.



In order to indicate authorized operation and to prevent from unintended alteration, the codeword must be entered before any alteration can be performed.



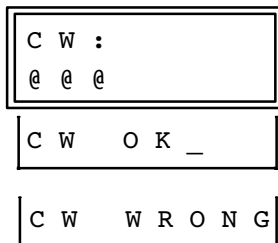

When an operation object is selected which requires codeword input, press one of the keys  or  in order to inform the relay about the intended alteration. The display then shows the line "CW :." which indicates that the codeword is required. The 'codeword' itself consists of the key sequence   . Press these keys in the indicated sequence and confirm with the enter key **E**. If the codeword is correct the display shows "CW OK_". By pressing the enter key **E** one more time the operation item is displayed again. Use the keys  or  in order to change the presented text or numerical value. A flashing cursor indicates that the relay operates now in alteration mode, starting with the first alteration and ending after confirmation of the altered item with the enter key **E**. The alteration mode is equally ended when the setting menu is left or after an internal waiting time.

The codeword is not required for the read-out of annunciations, operating data or fault data, or for the read-out of setting parameters.







The entered characters do not appear in the display, instead only a symbol @ appears. After confirmation of the correct input with **E** the display responds with **CW OK_**. Press the entry key **E** again.

If the codeword is not correct the display shows **CW WRONG**. Pressing the keys  or  allows another attempt at codeword entry.

The operating interface is built up by a hierarchically structured menu tree, which can be passed through by means of the scrolling keys , , , and . Thus, each operation object can be reached. A complete overview is listed in Appendix C. Figure 5.3 illustrates the way to get to the configuration items.

After the relay has been switched on, the display shows the type designation and the version of the implemented firmware. Pressing the key  leads to the first main menu item "PARAME." (parameters) in

the first operation level of the menu tree. Press key  to reach the second operation menu level, which starts with the first parameter block "00 CONF." (configuration). Press the key  repeatedly until address block 71 appears. You may scroll back with the key  or page to the previous operation menu level with .

Next to the address block number (71), the heading of the address block appears in abbreviated form: "INT. OP" (integrated operation).



[7100]
Beginning of the block "Integrated operation"

Address blocks 71 to 74 are provided for configuration of the software operating system. These settings concern the operation of the relay, communication with external operating and processing devices via the serial interface, and the interaction of the device functions.

You may, for example, change with the key \triangleright to the third operation menu level, then with key \triangleleft back to the second operation menu level, as shown in Figure 5.3.

Press the key ∇ to change to address block 72, etc.

The display shows the two-figure address block number and the meaning of the requested parameter (Figure 5.3). In the second display line follows the text or number which is presently applicable. The preset text or number can be altered by pressing the keys \oplus or \ominus .

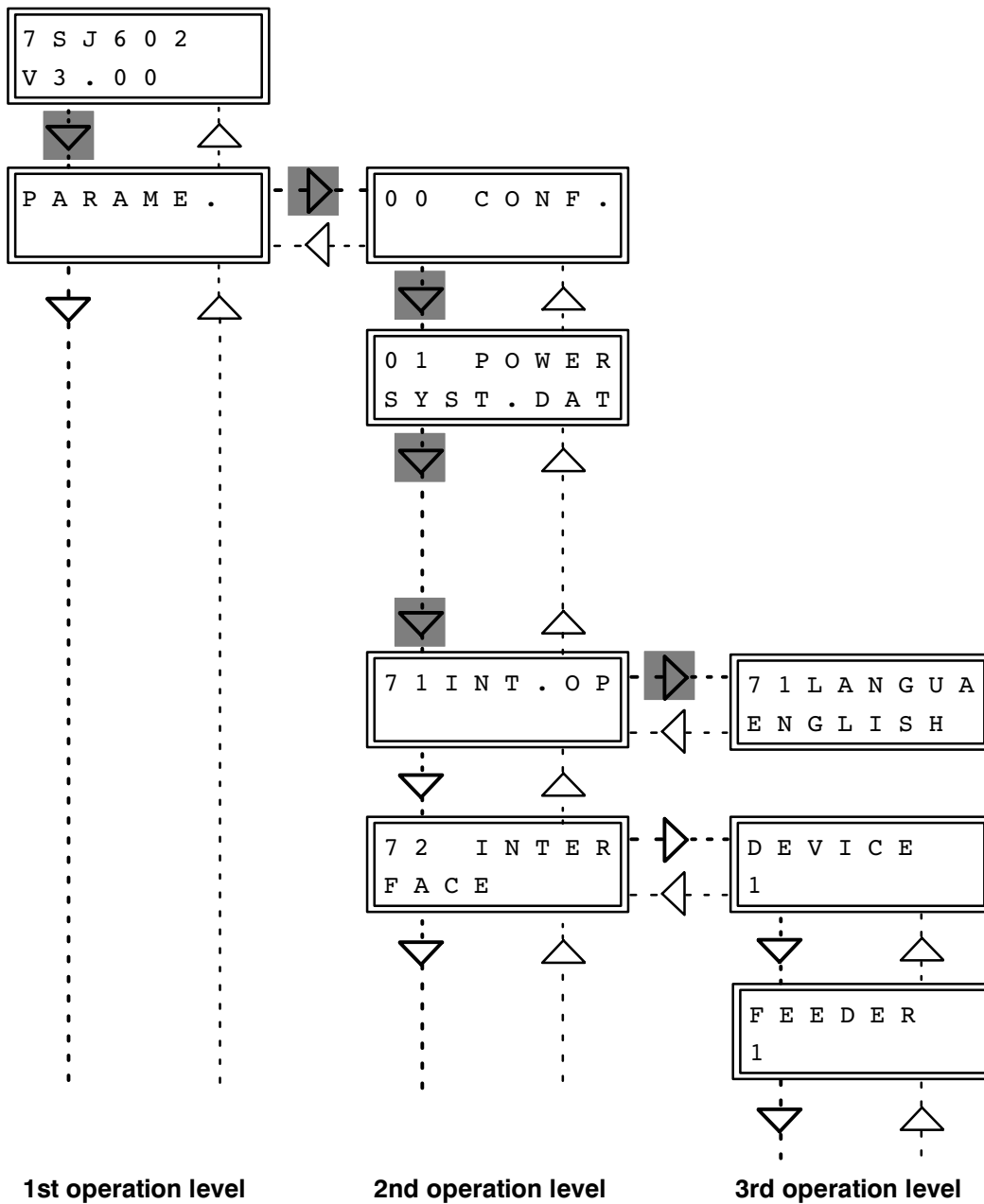

Figure 5.3 Extract from the operation structure and illustration of selection of the configuration blocks

When the relay is operated from a personal computer by means of the protection data processing program DIGSI[®], each configuration parameter is identified by a four-digit address number. In the following clarifications, this number is indicated at the beginning of the explanations in brackets.

For text parameters, an alternative text appears which is illustrated in the explanations below. Multiple alternatives may be possible. The alternative which is chosen, **is confirmed with the enter key E**. When the last possible alternative is reached, no further changing with the key \boxplus is possible. The same is valid when one tries to change the first alternative with the key \boxminus .

If a numerical value of the parameter is required, the preset number can equally be changed with the keys \boxplus or \boxminus in order to get a higher or lower number. The desired value **must be confirmed with the enter key E!**

When one of the keys, \boxplus or \boxminus , is pressed continuously, the numbers will change with an accelerating sequence. Thus, a fast and fine adjustment is possible within a wide setting range.

If one tries to leave an operating item or operating level by pressing one of the arrow keys without having confirmed an alteration with the enter key **E**, the display will show the question "SAVE NEW SETTING?". Confirm with the "Yes" – key **Y/J** that the new settings shall become valid now. If you press the "No" – key **N** instead, codeword operation will be aborted, and the alteration which has been changed since the last entry is lost. Thus, erroneous alterations can be made ineffective. Press the arrow key once again in order to change really the operating item or level.

When the configuration or setting process is terminated by pressing the enter key **E**, the altered parameters are permanently secured in EEPROMs and protected against power outage.

If no operation has taken place for more than 10 minutes, the relay terminates the setting mode and reverts to the default display, i.e. indication of the measured values. Alterations which have not yet been saved are lost. With the \blacktriangleleft – key the last used operating level is reached.

5.3.2 Settings for the integrated operation – address block 71

Operating parameters can be set in address block 71. This block allows the operating language to be selected.

When the relay is delivered from the factory, the device is programmed to give function names and outputs in the English language. This can be changed

under address block 71. This item is reached from the second operation level, address block 71 (as described above) by changing with the key \blacktriangleright to the third operation level where the operation language may be changed. The operator languages available at present are shown in the boxes below.

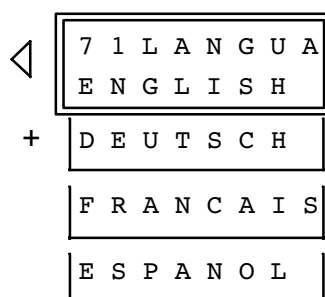

[7101]

The available languages can be called up by repeatedly pressing the key \boxplus or \boxminus . Each language is spelled in the corresponding national language. If you don't understand a language, you should find your own language, nevertheless.

The required language is chosen with the enter key **E**.

5.3.3 Configuration of the serial interfaces – address block 72

The device provides a serial operator interface (or PC interface) and – dependent on the version – a serial system interface. Communication via this interfaces requires some data prearrangements: identification of the relay, transmission format, transmission speed.











These data are entered to the relay in address block 72. Codeword input is necessary (refer to Section 5.3.1). The data must be coordinated with the connected devices.

The setting of the GAPS is relevant only when the relay is intended to communicate via a modem. The setting is the maximum time period which is tolerated by the relay when gaps occur during transmission of a telegram. Gaps may occur, when modems

are used, by compression of data, error correction, and differences of the Baud-rate. With good transmission quality, 1.0 s is adequate. The value should be increased when transmission quality is not so good. It must be noted that GAPS must be smaller than the setting of "reaction time protection relay" in the protection software DIGSI® V3. Recommended value:

$$\text{GAPS} \approx \frac{\text{"reaction time protection relay"}}{2}$$

Higher values for "reaction time protection relay" reduce the transmission speed in case of transmission errors. If the relay interface is connected directly to a personal computer, then GAPS may be set to 0.0 s.

 <div style="border: 1px solid black; padding: 5px; display: inline-block;"> 7 2 I N T E R F A C E </div> 	<p>[7200] Beginning of the block "Interface for personal computer"</p>
 <div style="border: 1px solid black; padding: 5px; display: inline-block;"> 7 2 D E V I C E 1 </div> 	<p>[7201] Identification number of the relay within the substation; The number can be chosen at liberty, but must be used only once within the plant system Smallest permissible number: 1 Largest permissible number: 254</p>
 <div style="border: 1px solid black; padding: 5px; display: inline-block;"> 7 2 F E E D E R 1 </div> 	<p>[7202] Number of the feeder within the substation; Smallest permissible number: 1 Largest permissible number: 254</p>
 <div style="border: 1px solid black; padding: 5px; display: inline-block;"> 7 2 S U B S T A 1 </div> 	<p>[7203] Identification number of the substation, in case more than one substation can be connected to a central device Smallest permissible number: 1 Largest permissible number: 254</p>
 <div style="border: 1px solid black; padding: 5px; display: inline-block;"> 7 2 F - T Y P E 1 6 0 </div> 	<p>[7208] Function type in accordance with IEC 60870–5–103; for time overcurrent protection no. 160. This address is mainly for information, it should not be changed.</p>

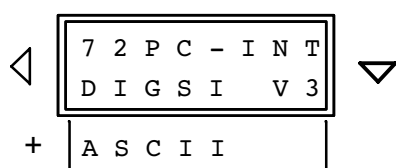

[7211]

Data format for the PC (operating) interface:

format for Siemens protection data processing program
DIGSI® Version V3

ASCII format

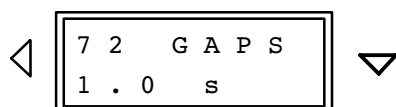

[7214]

Maximum time period of data gaps which may occur during
data transmission via modem

Smallest setting value:

0.0 s

Largest setting value:

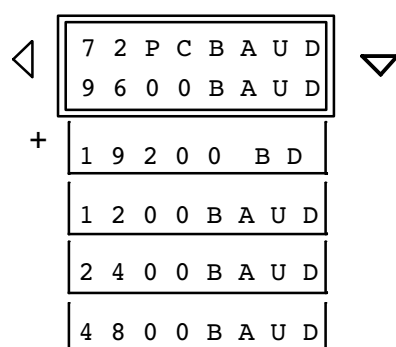
5.0 s

[7215]

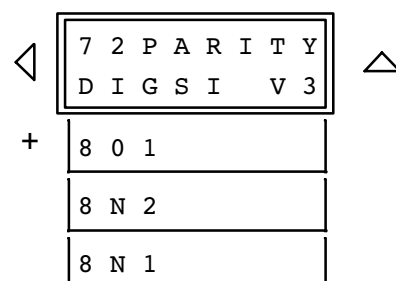
The transmission baud rate for communication via the PC
(operating) interface can be adapted to the operator's com-
munication interface, e.g. personal computer, if necessary.
The available possibilities can be displayed by repeatedly
depression of the key + or -. Confirm the desired Baud-
rate with the entry key E.

[7216]

Parity and stop-bits for the PC (operating) interface:

format for Siemens protection data processing program
DIGSI® Version V3 with even parity and 1 stop-bit

transmission with Odd parity and 1 stop-bit

transmission with No parity and 2 stop-bits

transmission with No parity and 1 stop-bit

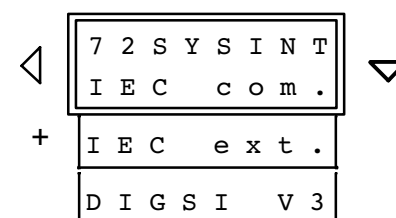

[7221]

Data format for system interface

compatible with IEC 60870-3-105

compatible with IEC 60870-3-105 and extended

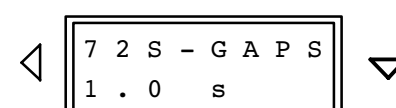
Format for *DIGSI*® version V3

[7224]

Transmission gaps for system interface

Smallest setting value:

0.0 s

Largest setting value:

5.0 s

◁

7 2 S - B A U D
9 6 0 0 B A U D

 ▾

+

1 9 2 0 0 B D
1 2 0 0 B A U D
2 4 0 0 B A U D
4 8 0 0 B A U D

[7225]

The transmission baud rate for system interface can be adapted.

The available possibilities can be displayed by repeatedly depression of the key + or -. Confirm the desired baud rate with the entry key **E**.

◁

7 2 S - P A R I
I E C / D I G S

 △

+

8 O 1
8 N 2
8 N 1

[7226]

The parity of the system interface can be adapted:

format for Siemens protection data processing program *IEC/DIGSI*® V3/LSA with even parity and 1 stop-bit

transmission with Odd parity and 1 stop-bit

transmission with No parity and 2 stop-bits

transmission with No parity and 1 stop-bit

◁

7 2 S - S W I T
N O

 △ ▾

+

Y E S

[7227]

Online switch IEC – DIGSI enabled

◁

7 2 S - T O U T
1 . 0 s

 ▾

[7233]

Supervision time for system interface

Smallest setting value: **1.0 s**

Largest setting value: **600,0 s**
and ∞

◁

7 2 S - P A R A
N O

 △ ▾

+

Y E S

[7235]

Parameterizing via system interface

◁

7 2 S W . R E M
O F F

 ▾

+

O N

[7240]

Blocking of monitoring direction via system interface

OFF or ON

5.3.4 Settings for fault recording – address block 74











The time overcurrent protection relay is equipped with a fault data store (see Section 4.8.2). Distinction must be made between the reference instant and the storage criterion. Normally, the general fault detection signal of the protection is the reference instant. The storage criterion can be the general fault detection, too (*RECbyFT*), or the trip command (*RECbyTP*). Alternatively, the trip command can be selected as reference instant (*SRTwitTP*), in this case, the trip command is the storage criterion, too.

A fault event begins with the fault detection of any protection function and ends with drop-off of the latest fault detection. The scope of a fault record is nor-

mally this fault event.

The actual recording time starts with the pre-trigger time T–PRE before the reference instant and ends with the post-fault time T–POS after the recording criterion has disappeared. The permissible recording time for each record is set as T–MAX. Altogether 5 s are available for fault recording. In this time range up to 8 fault records can be stored.

Note: The set times are related on a system frequency of 50 Hz. They are to be matched, accordingly, for different frequencies.

 <div style="border: 1px solid black; padding: 5px; display: inline-block;"> 7 4 F A U L T R E C O R D E R </div> 	<p>[7400] Beginning of block "Fault recordings"</p>
 <div style="border: 1px solid black; padding: 5px; display: inline-block;"> 7 4 R E C i n i R E C b y F T </div> <div style="border: 1px solid black; padding: 5px; display: inline-block;"> + R E C b y T P </div> <div style="border: 1px solid black; padding: 5px; display: inline-block;"> S R T w i t T P </div> 	<p>[7402] Data storage is initiated:</p> <ul style="list-style-type: none"> – fault detection is reference instant fault detection is storage criterion – fault detection is reference instant trip command is storage criterion – trip command is reference instant trip command is storage criterion
 <div style="border: 1px solid black; padding: 5px; display: inline-block;"> 7 4 T - M A X 1 . 0 0 s </div> 	<p>[7410] Maximum time period of one fault record Smallest setting value: 0.30 s Largest setting value: 5.00 s</p>
 <div style="border: 1px solid black; padding: 5px; display: inline-block;"> 7 4 T - P R E 0 . 1 0 s </div> 	<p>[7411] Pre-trigger time before the reference instant Smallest setting value: 0.05 s Largest setting value: 0.50 s</p>
 <div style="border: 1px solid black; padding: 5px; display: inline-block;"> 7 4 T - P O S 0 . 1 0 s </div> 	<p>[7412] Post-fault time after the storage criterion disappears Smallest setting value: 0.05 s Largest setting value: 0.50 s</p>

5.4 Configuration of the protective functions

5.4.1 Introduction

The device 7SJ602 provides a series of protection and additional functions. The scope of the hard- and firm-ware is matched to these functions. Furthermore, individual functions can be set (configured) to be effective or non-effective by configuration parameters. A preselection of the characteristics of the time overcurrent protection can be made, additionally.

Example for configuration of the scope of functions: Assume a network comprising overhead lines and cable sections. Overload protection is only reasonable for the cable sections, this function will be "de-configured" for the devices protecting the overhead line sections.

The configuration parameters are input through the integrated operation keyboard at the front of the device or by means of a personal computer, connected to the operation interface. The use of the integrated operating keyboard is described in detail in Section 6.2. Alteration of the programmed parameters requires the input of the codeword (see Section 5.3.1). Without codeword, the setting can be read out but not altered.

For the purpose of configuration, address block 00 is provided. This block is reached from the initial display in operation level 1 with the key ▽ ("PARAME.") and changing with key ▷ to the second operation level. Address block 00 CONFiguration appears (Figure 5.4).

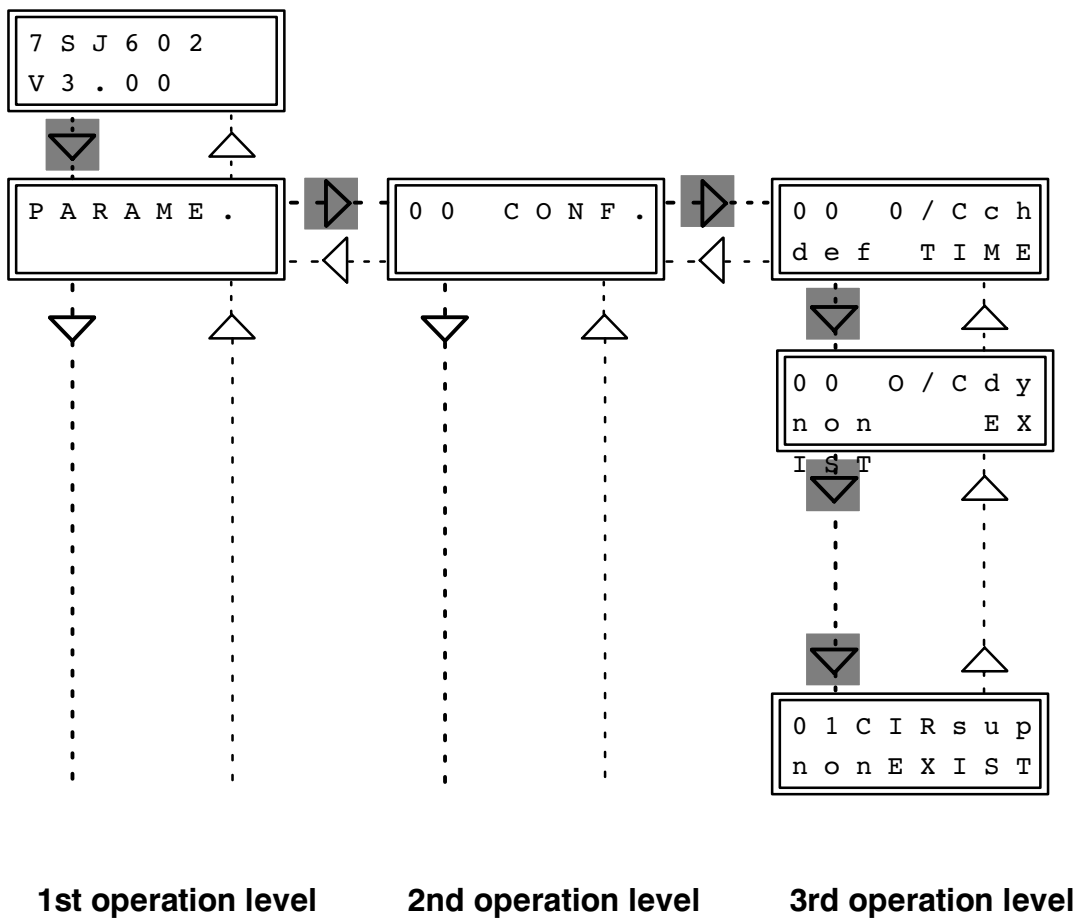

Figure 5.4 Extract from the operation structure and illustration of selection of the configuration block

Within the block 00 one can page with key \triangleright to the third operation level and scroll on with key ∇ or scroll back with key Δ . Each paging action leads to a further operation object for the input of a configuration parameter. In the following sections, each operating object is shown in a box and explained. In the upper line of the display, behind the block number, stands the associated device function. In the second line is the associated text (e.g. "EXIST"). If this text is appropriate the arrow keys ∇ or Δ can be used to page the next or previous operating item. If the text should be altered, press the keys \boxplus or \boxminus , after having input the codeword; an alternative text then appears (e.g. "nonEXIST"). There may be other alternatives which can then be displayed by repeated depression of the keys \boxplus or \boxminus . When the last possible alternative is reached, no further changing with the key \boxplus is possible. The same is valid when one tries to change the first alternative with the key \boxminus . The required alternative **must be confirmed with the key E!**

When the relay is operated from a personal computer by means of the protection data processing program DIGSI[®], each configuration parameter is identified by a four-digit address number. In the following clarifications, this number is indicated at the begin-

ning of the explanations in brackets.

If one tries to leave an operating item or operating level by pressing one of the arrow keys without having confirmed an alteration with the enter key **E**, the display will show the question "SAVE NEW SETTING?". Confirm with the "Yes"–key **Y/J** that the new settings shall become valid now. If you press the "No"–key **N** instead, codeword operation will be aborted, and the alteration which has been changed since the last entry is lost. Thus, erroneous alterations can be made ineffective. Press the arrow key once again in order to change really the operating item or level.

When the configuration or setting process is terminated by pressing the enter key **E**, the altered parameters are permanently secured in EEPROMs and protected against power outage.

With the arrow key \blacktriangleleft (one level back), the second operation level can be reached where you may scroll with key ∇ to the next address block. If you press the arrow key \blacktriangleleft once again, the first operation level is reached.

5.4.2 Programming the scope of functions – address block 00

The available protective and additional functions can be programmed as existing or not existing. For some functions it may also be possible to select between multiple alternatives.

Functions which are **configured** as *nonEXIST* will not be processed in 7SJ602: There will be no annunciations and the associated setting parameters (functions, limit values) will not be requested during setting (Section 6.3). In contrast, **switch-off** of a

function means that the function will be processed, that indication will appear (e.g. "... switched off") but that the function will have no effect on the result of the protective process (e.g. no tripping command).

The following boxes show the possibilities for the maximum scope of the device. In an actual case, functions which are not available will not appear in the display.



[7800]
Beginning of block "Configuration of the scope of functions"

Overcurrent protection:

Preselection of tripping characteristic

◁

0 0	O / C c h
d e f	T I M E

 ▷

+

I > > >	I > >
---------	-------

I E C	i n v .
-------	---------

A N S I	i n v
---------	-------

I E C	O / C
-------	-------

A N S I	O / C
---------	-------

n o n E X I S T

[7801]

Only definite time characteristics (for phase and earth currents) are available

Only the high current stage I>> and the instantaneous very high current stage I>>> (for phase currents) and the high current stage I_E>> (for earth current) are available

Attention! This option must only be used without auto-reclosure, as these stages will be blocked after the first auto-reclose cycle!

The four inverse time characteristics according IEC are available (refer to Figures 3.1 and 3.2, Section 3.3), besides the high-current and very high current stages

The eight inverse time characteristics according ANSI are available (refer to Figures 3.3 and 3.4, Section 3.3), besides the high-current and very high current stages

The definite time stages as well as the four inverse time characteristics according IEC are available (refer to Figures 3.1 and 3.2, Section 3.3), besides the high-current and very high current stages

The definite time stages as well as the eight inverse time characteristics according ANSI are available (refer to Figures 3.3 and 3.4, Section 3.3), besides the high-current and very high current stages

No overcurrent protection is available

[7802] Dynamic switch-over of pick-up values

◁

0 0	O / C d y
n o n E X I S T	

 ▷

+

E X I S T

[7805] Start-up time supervision:

◁

0 1	S T R T
n o n E X I S T	

 ▷

+

E X I S T

[7803] Unbalanced load protection:

◁

0 1	U N B . L
n o n E X I S T	

 ▷

+

E X I S T

[7834] Automatic reclosure:

◁

0 1	A R
n o n E X I S T	

 ▷

+

E X I S T

[7804] Thermal overload protection:

◁

0 1	O / L
n o n E X I S T	

 ▷

+

p r e L O A D

 with total memory (preload considered)

n o p r e L D

 without memory (no preload)

[7839] Trip circuit supervision:

◁

0 1	C I R s u p
n o n E X I S T	

 ▷

+

w i t h 2 B I

b y p a s s - R

5.5 Marshalling of binary inputs, binary outputs and LED indicators

5.5.1 Introduction

The functions of the binary inputs and outputs represented in the general diagrams (Appendix A) relate to the factory settings. The assignment of the inputs and outputs of most of the internal functions can be rearranged and thus adapted to the on-site conditions.

Marshalling of the inputs, outputs and LEDs is performed by means of the integrated operator panel or via the operating interface. The operation of the operator panel is described in detail in Section 6.2. Marshalling begins at the address block 60.

The input of the codeword is required for marshalling (refer to Section 5.3.1). Without codeword entry, parameters can be read out but not be changed. A flashing cursor indicates that the relay operates now in alteration mode, starting with the first alteration and ending after confirmation of the altered item with the enter key **E**. The alteration mode is equally ended when the setting menu is left or after an internal waiting time.

When the firmware programs are running the specific logic functions will be allocated to the physical input and output modules or LEDs in accordance with the selection.

Example: A fault is registered from any of the integrated protection functions. This event is generated in the device as an "Annunciation" (logical function) and should be available at certain terminals of the unit as a N.O. contact. Since specific unit terminals are hard-wired to a specific (physical) signal relay, e.g. to the signal relay 2, the processor must be advised that the logical signal "FT det" (fault detected) should be transmitted to the signal relay 2. Thus, when marshalling is performed two statements of the operator are important: **Which** (logical) annunciation generated in the protection unit program should trigger **which** (physical) signal relay? Up to 20 logical annunciations can trigger one (physical) signal relay.

A similar situation applies to binary inputs. In this case external information (e.g. blocking of I>> stage) is connected to the unit via a (physical) input module and should initiate a (logical) function, namely blocking. The corresponding question to the operator is then: **Which** signal from a (physical) input relay should initiate **which** reaction in the device? One physical input signal can initiate up to 10 logical functions.

The trip relays can also be assigned different functions. Each trip relay can be controlled by each command function or combination of command functions.

The logical annunciation functions can be used in multiple manner. E.g. one annunciation function can trigger several signal relays, several trip relays, additionally be indicated by LEDs, and be controlled by a binary input unit.

The marshalling procedure is set up such that for each (physical) binary input, each output relay, and for each marshallable LED, the operator will be asked which (logical) functions should be allocated.

The offered logical functions are tabulated for the binary inputs, outputs and LEDs in the following sections.

The marshalling block is reached with the keys ∇ (scrolling forwards) or Δ (scrolling backwards), \triangleright (next operation level) or \triangleleft (previous operation level), i.e. from the initial display (Figure 5.5):

- key ∇ (forwards),
- key \triangleright (second operation level),
- key ∇ (forwards) until address block 60 appears in the display.



[6000]
Beginning of marshalling blocks

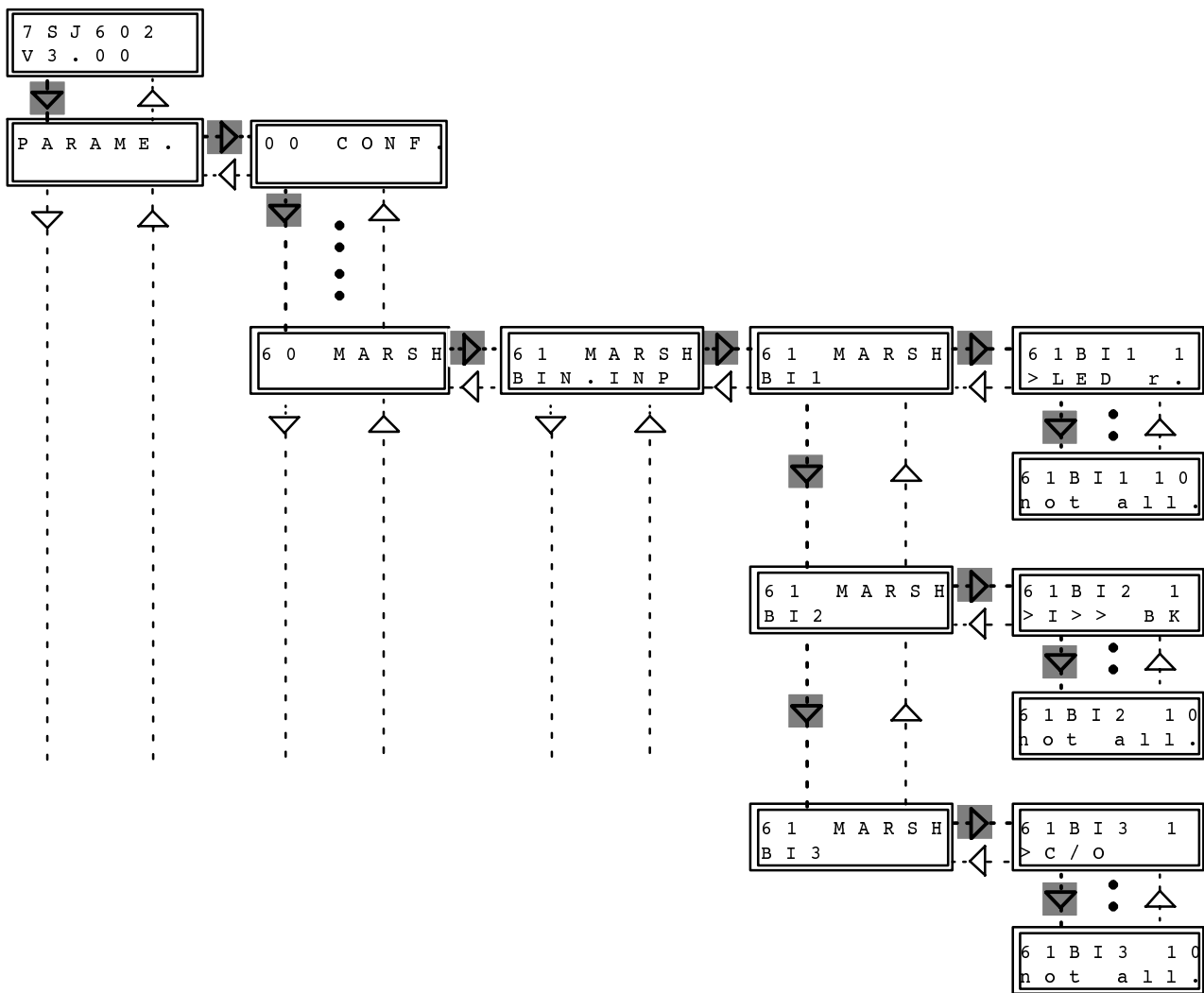

1st operation level

2nd operation level

3rd operation level

4th operation level

5th operation level

Figure 5.5 Extract from the operation structure and illustration of selection of the marshalling blocks

You may, for example, change with the key \triangleright to the next operation menu level, then with key \triangleleft back to the previous operation menu level, as shown in Figure 5.5. Within a menu level, key ∇ is used to scroll forwards or \triangle to scroll backwards. Each forward or backward step in the fourth operation level leads to display of the next input, output or LED position. In the display the physical input/output unit forms the heading.

Key \triangleright leads to the selection level of an individual input/output module. The display shows, in the upper line, the physical input/output unit, this time with a one to two digit index number. The second display line shows the logical function which is presently allocated.

On this selection level the allocated function can be changed after codeword input by pressing the key \oplus . By repeated use of the key \oplus all marshallable functions can be paged through the display. Back-paging is possible with the key \ominus . When the required function appears press the execute key **E**. After this, further functions can be assigned to the same physical input or output module (with further index numbers) by using the key ∇ . **Each selection must be confirmed by pressing the key E!** If a selection place shall not be assigned to a function, selection is made with the function "not all." (not allocated).

You can leave the selection level by pressing the key \triangleleft . The display shows again the previous selection level. Now you can page with key ∇ to the next input/output module or with \triangle to the previous to repeat selection procedure, as above.

In the following paragraphs, allocation possibilities for binary inputs, binary outputs and LED indicators are given. The arrows ∇ Δ or \triangleright \triangleleft at the left hand side of the display box indicate paging from operation level to another operation level, within the operation level or selection level. Those arrows which lead to the next operating step in a logical sequence are indicated in bold figures.

The function numbers and designations are listed completely in Appendix C.

When the relay is operated from a personal computer by means of the protection data processing program DIGSI[®], each configuration parameter is identified by a four-digit address number. In the following clarifications, this number is indicated at the beginning of the explanations in brackets.

If one tries to leave an item or operating level by pressing one of the arrow keys without having confirmed the allocation with the enter key **E**, the display will show the question "SAVE NEW SETTING?". Confirm with the "Yes"–key **Y/J** that the new settings shall become valid now. The new text is displayed now. If you press the "No"–key **N** instead, all alterations which has been changed since the last entry of the key **E** are lost and the old text is displayed. Thus, erroneous alterations can be made ineffective. Press the arrow key once again in order to change really the operating item or level.

When the marshalling process is terminated by pressing the enter key **E**, the allocations are permanently secured in EEPROMs and protected against power outage.

5.5.2 Marshalling of the binary inputs – address block 61

The unit contains 3 binary inputs which are designated INPUT 1 to INPUT 3. They can be marshalled in address block 61. The block is reached from the initial display by pressing the key ∇ to the first main menu item "PARAME." (parameters) in the first operation level of the menu tree. Press key \triangleright to reach the second operation menu level, which starts with the first parameter block "00 CONF." (configuration). Press the key ∇ repeatedly until address block "60 MARSH" (marshalling) appears. Key \triangleright leads to operation level 3 with address block "61 MARSH BIN INP" (marshalling of binary inputs) (refer also to Figure 5.5).

The selection procedure is carried out as described in Section 5.5.1.

A choice can be made for each individual input function as to whether the desired function should become operative in the "normally open" mode or in the "normally closed" mode, whereby:

- (no index) "normally open" mode: the input acts as a NO contact, i.e. the control voltage at the input terminals activates the function;

- n – "normally closed" mode: the input acts as a NC contact, i.e. control voltage present at the terminals turns off the function, control voltage absent activates the function.

When paging through the display with \boxplus or \boxminus , each input function is displayed without any index which indicates the "normally open" mode and with the index "n" which indicates the "normally closed" mode, as above. The changed function then must be re-confirmed by the entry key **E**.

Table 5.5 shows a complete list of all the binary input functions with their associated function number **FNo**. Input functions naturally have no effect if the corresponding protection function has been programmed out ("de-configured", refer Section 5.4.2).

The assignment of the binary inputs as delivered from factory is shown in the general diagrams in Appendix A. The following boxes show, as an example, the allocation for binary input 1. Table 5.6 shows all binary inputs as preset from the factory.

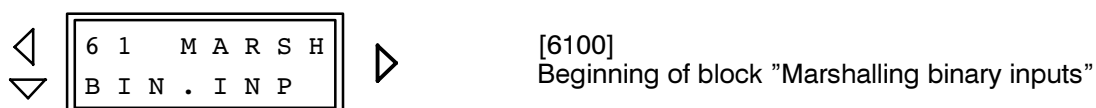

The first binary input is reached with the key \triangleright :



Change over to the selection level with \triangleright :

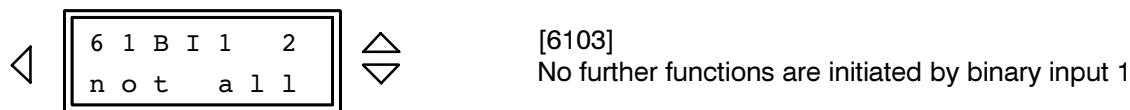
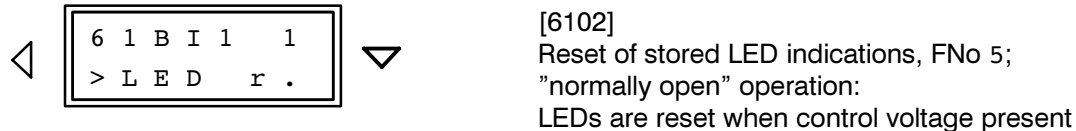

Following codeword input, all marshallable functions can be paged through the display by repeated use of the key \boxplus . Back-paging is possible with the key \boxminus . When the required function appears press the execute key **E**. After this, further functions can be allocated to the same physical input or output module (with further index numbers 1 to 10) by using the key ∇ . **Each selection must be confirmed by pressing the key E!** If a selection place shall not be assigned to a function, selection is made with the function "not all." (not allocated).

Leave the selection level with key \triangleleft . You can go then to the next binary input with the arrow key ∇ .

FNo	Abbreviation	Description
1	not all.	Binary input is not allocated to any input function
5	>LED r.	Reset LED indicators
11	>Annu.1	>User defined annunciation 1
12	>Annu.2	>User defined annunciation 2
13	>Annu.3	>User defined annunciation 3
14	>Annu.4	>User defined annunciation 4
15	>SysTst	>Testing via system interface
16	>SysMMb	>Block. of monitoring dir. via sys.-int
356	>mCLOSE	Circuit breaker is manually closed (from discrepancy switch)
1157	>CBclo	Circuit breaker closed (from CB auxiliary contact)
1501	>O/L on	Switch on thermal overload protection
1502	>O/L off	Switch off thermal overload protection
1503	>O/L bk	Block thermal overload protection
1701	>O/Cpon	Switch on time overcurrent protection for phase currents
1702	>O/Cpof	Switch off time overcurrent protection for phase currents
1704	>O/Cpbk	Block time overcurrent protection for phase currents
1711	>O/Ce on	Switch on time overcurrent Xprotection for earth current
1712	>O/Ce of	Switch off time overcurrent Xprotection for earth current
1714	>O/Ce bk	Block time overcurrent Xprotection for earth current
1721	>I>> bk	Block I>> stage of time overcurrent Xprotection (phase faults)
1722	>I> blk	Block I> stage of definite time overcurrent protection (phase faults)

Table 5.5 Marshalling possibilities for binary inputs (continued next page)

FNo	Abbreviation	Description
1723	>Ip blk	Block I _p stage of inverse time overcurrent protection (phase faults)
1724	>IE>>bk	Block I _{E>>} stage of time overcurrent protection (earth faults)
1725	>IE> bk	Block I _{E>} stage of definite time overcurrent protection (earth faults)
1726	>IEp bk	Block I _{E_p} stage of inverse time overcurrent protection (earth faults)
1727	>C/O	Change over of overcurrent fault detection level
2701	>AR on	Switch on internal auto-reclosure function
2702	>AR off	Switch off internal auto-reclosure function
2732	>AR St.	Start internal auto-reclosure function (initiation)
2733	>ARblSt	Block initiation of internal auto-reclosure function
2734	>ARblCl	Block reclose command of internal auto-reclosure function
4632	>SWblo.	Block control facility
5143	>I2 blk	Block unbalanced load protection
5144	>revPhR	Reversed phase rotation
6758	>I>>>bk	Block I>>> stage (inst.. very high stage) of time overcurrent protection
6801	>SRT bk	Block start-up time supervision
6851	>SUP bk	Blocking trip circuit supervision
6852	>TrpRel	Trip circuit supervision: Trip relay
6853	>CBaux	Trip circuit supervision: CB auxiliary

Table 5.5 Marshalling possibilities for binary inputs

The complete pre-settings are listed in Table 5.6.

4th selection level	5th selection level	FNo	Remarks
MARSHALLING	BINARY INPUTS		Heading of the address block
6 1 M A R S H B I 1	6 1 B I 1 1 > L E D r .	5	Acknowledge and reset of stored LED and displayed fault indications, LED-test
6 1 M A R S H B I 2	6 1 B I 2 1 > I > > b k	1721	Block I>> stage of time overcurrent protection for phase faults
6 1 M A R S H B I 3	6 1 B I 3 1 > m C L O S E	356	Circuit breaker is manually closed (from discrepancy switch)

Table 5.6 Preset binary inputs

5.5.3 Marshalling of the output relays – address block 64

The unit contains 4 binary outputs (output relays for commands and signalling). These output relays are designated CMD.RE 1 to CMD.RE 4 and can be marshalled in address block 64. The block is reached from the initial display by pressing the key ▽ to the first main menu item "PARAME." (parameters) in the first operation level of the menu tree. Press key ▷ to reach the second operation menu level, which starts with the first parameter block "00 CONF." (configuration). Press the key ▽ repeatedly until address block "60 MARSH" (marshalling) appears. Key ▷ leads to operation level 3 with address block "61 MARSH BIN INP" (marshalling of binary inputs); key ▽ leads to address block "64 MARSH CMD REL" (marshalling command/signal relays).

The selection procedure is carried out as described in Section 5.5.1. Multiple annunciations are possible, i.e. one logical annunciation function can be routed to several physical output relays (see also Section 5.5.1).

Table 5.7 gives a listing of all annunciation functions with the associated function numbers FNo. Annunciation functions are naturally not effective when the corresponding protection function is not available or has been programmed out ("de-configured" – refer Section 5.4.2).

The assignment of the output relays as delivered from factory is shown in the general diagrams in Appendix A. The following boxes show an example for marshalling for output relay 1. Table 5.8 shows all output relays as preset from the factory.

Note as to Table 5.7: Annunciations which are indicated by a leading ">" sign, represent the direct confirmation of the binary inputs and are available as long as the corresponding binary input is energized.

Further information about annunciations see Section 6.4.

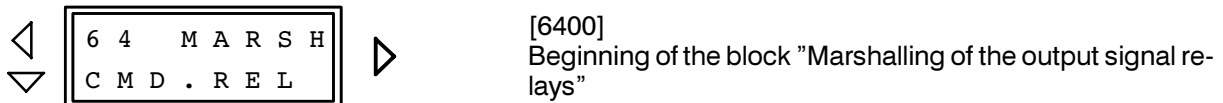

The first signal relay is reached with the key ▷ :



Change over to the selection level with ▽ :

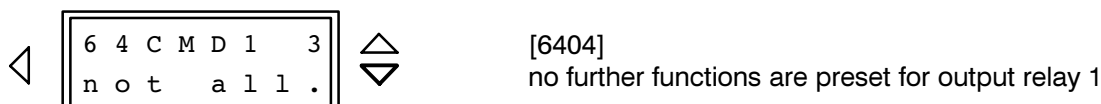
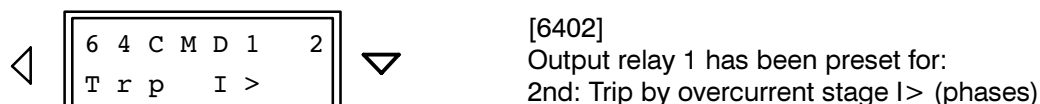
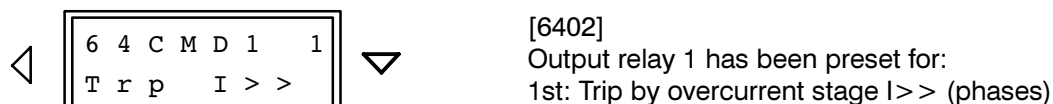

Following codeword input, all marshallable functions can be paged through the display by repeated use of the key \boxplus . Back-paging is possible with the key \boxminus . When the required function appears press the execute key **E**. After this, further functions can be allocated to the same output relay (with further index numbers 1 to 20) by using the key ∇ . **Each selection must be confirmed by pressing the key E!** If a selection place shall not be assigned to a function, selection is made with the function "not all." (not allocated).

Leave the selection level with key \blacktriangleleft . You can go then to the next output relay with the arrow key ∇ .

FNo	Abbreviation	Description
1	not all.	No annunciation allocated
5	>LED r.	Reset LED indicators
11	>Annu.1	>User defined annunciation 1
12	>Annu.2	>User defined annunciation 2
13	>Annu.3	>User defined annunciation 3
14	>Annu.4	>User defined annunciation 4
52	operat.	At least one protection function is operative
60	LED res	Stored annunciations are reset
110	ANNlost	Annunciations lost (buffer overflow)
111	PCannLT	Annunciations for personal computer interface lost
115	ANNovfl	Fault annunciation buffer overflow
162	Fail Σ I	Failure: Current summation supervision
203	REC del	Fault recording data deleted
301	Sys.Flt	Fault in the power system
302	FAULT	Fault event with consecutive number
356	>mCLOSE	Circuit breaker is manually closed (from discrepancy switch)
501	FT det	General fault detection of device
511	DEV.Trp	General trip of device
563	CBA sup	CB alarm suppressed
1157	>CBclo	Circuit breaker closed
1174	CBtest	Circuit breaker test in progress
1185	CBtpTST	Circuit breaker test: Trip 3pole
1188	CBTwAR	Circuit breaker test: Trip 3pole with auto-reclosure
1501	>O/L on	Switch on thermal overload protection
1502	>O/Loff	Switch off thermal overload protection
1503	>O/Lblk	Block thermal overload protection
1511	O/L off	Thermal overload protection is switched off
1512	O/L blk	Thermal overload protection is blocked
1513	O/L act	Thermal overload protection is active
1516	O/L wrn	Thermal overload protection: Thermal warning stage
1518	O/L p/u	Thermal overload protection: Pick-up
1521	O/L Trp	Thermal overload protection: Trip
1701	>O/Cpon	Switch on time overcurrent protection for phase currents
1702	>O/Cpof	Switch off time overcurrent protection for phase currents
1704	>O/Cpbk	Block time overcurrent time protection for phase currents
1711	>O/Ceon	Switch on time overcurrent protection for earth current
1712	>O/Ceof	Switch off time overcurrent protection for earth current
1714	>O/Cebk	Block time overcurrent protection for earth current
1721	>I>>blk	Block I>> stage of time overcurrent protection (phase currents)
1722	>I> blk	Block I> stage of definite time overcurrent protection (phase currents)
1723	>Ip blk	Block I _p stage of inverse time overcurrent protection (phase currents)

Table 5.7 Marshalling possibilities for signal relays and LEDs (continued next page)

FNo	Abbreviation	Description
1724	>IE>>bk	Block $I_E>>$ stage of time overcurrent protection (earth current)
1725	>IE> bk	Block $I_E>$ stage of definite time overcurrent protection (earth current)
1726	>IEp bk	Block I_{Ep} stage of inverse time overcurrent protection (earth current)
1727	>C/O	Dynamic change-over of overcurrent fault detection pick-up values
1751	O/Cpoff	Time overcurrent protection phase is switched off
1752	O/Cpblk	Time overcurrent protection phase is blocked
1753	O/Cpact	Time overcurrent protection phase is active
1756	O/Ceoff	Time overcurrent protection earth is switched off
1757	O/Ceblk	Time overcurrent protection earth is blocked
1758	O/Ceact	Time overcurrent protection earth is active
1762	O/C L1	Fault detection of time overcurrent protection phase L1
1763	O/C L2	Fault detection of time overcurrent protection phase L2
1764	O/C L3	Fault detection of time overcurrent protection phase L3
1765	O/C E	Fault detection of time overcurrent protection earth fault
1800	FD I>>	Fault detection of time overcurrent protection stage $I>>$ phase currents
1805	Trp I>>	Trip by high-set $I>>$ stages for phase currents
1810	FD I>	Fault detection of time overcurrent protection stage $I>$ phase currents
1815	Trp I>	Trip by overcurrent $I>$ stage for phase currents
1820	FD Ip	Fault detection of overcurrent stage I_p for phase currents
1825	Trp Ip	Trip by overcurrent I_p stage for phase currents
1831	FD IE>>	Fault detection of high-set stage $I>>$ for phase currents
1833	Trp IE>>	Trip by overcurrent $I_E>>$ stage for earth currents
1834	FD IE>	Fault detection of overcurrent $I_E>$ stage for earth current
1836	Trp IE>	Trip by overcurrent $I_E>$ stage for earth current
1837	FD IEp	Fault detection of overcurrent I_{Ep} stage for earth current
1839	Trp IEp	Trip by overcurrent I_{Ep} stage for earth current
1850	FD dyn	Dynamic switch-over of overcurrent pick-up values
2701	>AR on	Switch on internal auto-reclosure function
2702	>AR off	Switch off internal auto-reclosure function
2732	>AR St.	Start internal auto-reclosure function (initiation)
2733	>ARblSt	Block initiation of internal auto-reclosure function
2734	>ARblCl	Block reclose command of internal auto-reclosure function
2736	AR act.	Internal auto-reclose function is active
2781	AR off	Internal auto-reclose function is switched off or blocked
2801	AR i pg	Internal auto-reclose cycle in progress
2851	AR ClCm	Internal auto-reclose function close command
2863	AR dTrp	Internal auto-reclose function definitive (final) trip
2872	AR Strt	Internal auto-reclosure function started
2873	AR blSt	Internal auto-reclosure function initiation is blocked
2874	AR blCl	Internal auto-reclosure function close command is blocked
2875	AR blMC	Internal auto-reclosure function is blocked by manual closure
2876	AR DT	Internal auto-reclosure function dead time is running
4632	>SWblo.	Block control facility
4640	Q0 Clo.	Control–Close–Command CB–Q0
4641	Q0 Trp.	Control–Trip–Command CB–Q0
5143	>I2 blk	Block unbalanced load protection
5144	>revPhR	Reversed phase rotation
5151	I2 off	Unbalanced load protection is switched off
5152	I2 blk	Unbalanced load protection is blocked
5153	I2 act	Unbalanced load protection is active
5159	FD I2>>	Fault detection of unbalanced load protection stage $I_2>>$
5165	FD I2>	Fault detection of unbalanced load protection stage $I_2>$
5170	Trp I2	Trip by unbalanced load protection stage $I_2>$

Table 5.7 Marshalling possibilities for signal relays and LEDs (continued next page)

FNo	Abbreviation	Description
6757	TrpI>>>	Trip by very high overcurrent stage I>>>, phases
6758	>I>>>bk	Instantaneous very high stage of time overcurrent protection is blocked
6801	>SRT bk	Block start-up time supervision
6811	SRT off	Start-up time supervision is switched off
6812	SRT blk	Start-up time supervision is blocked
6813	SRT act	Start-up time supervision is active
6821	SRT Trp	Trip by start-up time supervision
6851	>SUP bk	Block trip circuit supervision
6852	>TrpRel	Trip circuit supervision: binary input in parallel to trip relay
6853	>CBaux	Trip circuit supervision: binary input in parallel to CB auxiliary contact
6861	SUP off	Trip circuit supervision is switched off
6862	SUP blk	Trip circuit supervision is blocked
6863	SUP act	Trip circuit supervision is active
6864	SUPnoBI	Trip circuit supervision is inactive, binary input is not marshalled
6865	CIR int	Trip circuit is interrupted

Table 5.7 Marshalling possibilities for signal relays and LEDs

1st display line	2nd display line	FNo	Remarks
M A R S H	C M D . R E L		Heading of the address block
6 4 M A R S H	C M D 1		Trip by overcurrent protection phase currents (definite time I>>-stage or I>-stage)
6 4 C M D 1 - 1	T r p I > >	1805	
6 4 C M D 1 - 2	T r p I >	1815	
6 4 M A R S H	C M D 2		Trip by overcurrent protection earth current (definite time I _E >>-stage or I _E >-stage)
6 4 C M D 2 - 1	T r p I E > >	1833	
6 4 C M D 2 - 2	T r p T E >	1836	
6 4 M A R S H	C M D 2		General trip of the device: protection trip, control trip, and trip test
6 4 C M D 3 - 1	D E V . T r p	511	
6 4 C M D 3 - 2	Q 0 T r p .	4641	
6 4 C M D 3 - 3	C B t p T S T	1185	
6 4 M A R S H	C M D 2		General fault detection of the device
6 4 C M D 4 - 1	F T d e t	501	

Table 5.8 Preset annunciations for output relays

5.5.4 Marshalling of the LED indicators – address block 63

The unit contains 6 LEDs for optical indications, 4 of which can be marshalled. They are designated LED 1 to LED 4 and can be marshalled in address block 63. The block is reached from the initial display by pressing the key ∇ to the first main menu item "PARAM." (parameters) in the first operation level of the menu tree. Press key \triangleright to reach the second operation menu level, which starts with the first parameter block "00 CONF." (configuration). Press the key ∇ repeatedly until address block "60 MARSH" (marshalling) appears. Key \triangleright leads to operation level 3 with address block "61 MARSH BIN INP" (marshalling of binary inputs); key ∇ (twice) leads to address block "63 MARSH LED IND" (marshalling LED indicators).

The selection procedure is carried out as described in Section 5.5.1. Multiple annunciations are possible, i.e. one logical annunciation function can be routed to several LEDs (see also Section 5.5.1).

Apart from the logical function, each LED can be marshalled to operate either in the stored mode or unstored mode. Each annunciation function is displayed with the index m (for memorized) or without index (for not memorized) when proceeding with the key \boxplus .

The marshallable annunciation functions are the same as those listed in Table 5.7. Annunciation functions are, of course, not effective when the corresponding protection function has been programmed out (de-configured).

The changed function must be re-confirmed by the enter–key **E**.

The assignment of the LEDs as preset by the factory is shown in the front of the unit (Fig 6.1). The following boxes show, as an example, the assignment for LED 1. Table 5.9 shows all LED indicators as they are preset from the factory.



[6300]
Beginning of the block "Marshalling of the LED indicators"

The first marshallable LED is reached with the key \triangleright :

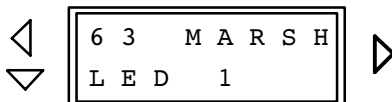

[6301]
Allocations for LED 1"

Change over to the selection level with \triangleright :

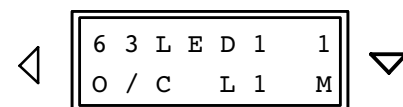

[6302]
LED 1 has been preset for:
1st: Fault detection of time overcurrent protection phase L1,
memorized, FNo 1762

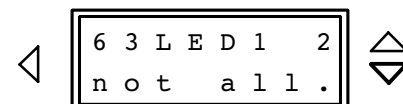

[6303]
No further functions are preset for LED 1

Following codeword input, all marshallable functions can be paged through the display by repeated use of the key \boxplus . Back-paging is possible with the key \boxminus . When the required function appears press the execute key **E**. After this, further functions can be allocated to the same LED indicator (with further index numbers 1 to 20) by using the key ∇ . **Each selection must be confirmed by pressing the key E!** If a selection place shall not be assigned to a function, selection is made with the function "not all." (not allocated).

Leave the selection level with key \triangleleft . You can go then to the next LED indicator with the arrow key ∇ .

4th selection level	5th selection level	FNo	Remarks
MARSHALLING	LEDs		Heading of the address block
6 3 M A R S H L E D 1	6 3 L E D 1 1 O / C L 1 M	1762	Fault detection of time overcurrent protection phase L1; memorized
6 3 M A R S H L E D 2	6 3 L E D 2 1 O / C L 2 M	1763	Fault detection of time overcurrent protection phase L2; memorized
6 3 M A R S H L E D 3	6 3 L E D 3 1 O / C L 3 M	1764	Fault detection of time overcurrent protection phase L3; memorized
6 3 M A R S H L E D 4	6 3 L E D 4 1 D E V . T r i p M	511	General trip of device; memorized

Table 5.9 Preset LED indicators

5.5.5 Marshalling of the auto-reclosure conditions – address block 65

The conditions of initiation and blocking of the internal auto-reclosure function can be freely assigned in address block 65. These are the input signals:

- Initiation (start) of the auto-reclosure function with the designation "AR MAR START",
- blocking of initiation of the auto-reclosure function with the designation "AR MAR ST.BLOCK",
- blocking of the auto-reclose command (statically) with the designation "AR MAR CL. BLOCK".

With these marshalling possibilities, it is, for example, possible to initiate the auto-reclose function by trip of the I>> stage of the time overcurrent protection but not to initiate it by trip of the I> stage or I_p stage. Each of the AR input signals may be controlled by up to 20 conditions. Additionally, external conditions can be included via binary inputs (refer to Section 5.5.2). If, for example, a binary input has been assigned to an AR input signal in address block 61, e.g. the function ">AR st" (FNo 2732) for AR initiation, this allocation need not be repeated here. All conditions which have been assigned to an AR input signal, are combined in OR mode.

Principally, the manual closing signal for the circuit breaker, if repeated to the relay via a binary input to

the function "manual close" (">mCLOSE", FNo 356), blocks auto-reclosure. This need not be considered here.

If readiness of the circuit breaker should be a condition for auto-reclosure, this condition can be entered to the relay via the binary input ">ARb1C1" (FNo 2734), which must then have been allocated to a physical input module in accordance with Section 5.5.2. Use the "normally closed" contact mode to release AR when the breaker is ready. This signal prevents from reclosing when it is present at the moment where reclosure command should be given. The blocking of start of the auto-reclose function ">ARb1St." (FNo 2733) is interrogated by the AR function only before and as long as initiation signal is present.

The block 65 is reached from the initial display by pressing the key ▽ to the first main menu item "PARAM." (parameters) in the first operation level of the menu tree. Press key ▾ to reach the second operation menu level, which starts with the first parameter block "00 CONF." (configuration). Press the key ▽ repeatedly until address block "60 MARSH" (marshalling) appears. Key ▾ leads to operation level 3 with address block "65 AR MARSHALL" (marshalling of auto-reclosure input signals).

In principle, all annunciation functions according to Table 5.7 can be assigned as condition for any AR input signal, but not all are meaningful. Conditions are naturally not effective when the corresponding protection function is not available in the actual mod-

el or has been programmed out (de-configured).

The following boxes show an example for marshalling of the "Start" signal (initiation of the auto-reclosure function).

◀
▼

6 5	A R
M A R S H A L L	

▶

[6500]
Beginning of the block "Marshalling of auto-reclosure input signals"

The first AR input signal is reached with the key ▶ :

◀
▼

6 5	A R M A R
S T A R T	

▶

[6501]
Allocations for the starting conditions of the auto-reclose function

Change over to the selection level with ▶ :

◀
▼

6 5	A R S 0 1
T r p I > >	

▼

Conditions for start of the AR may be for example:

[6502]
1st: Trip signal given by the phase time overcurrent protection high-set I>> stage

◀
▼

6 5	A R S 0 1
T r p I E > >	

▼

[6503]
2nd: Trip signal given by the earth time overcurrent protection high-set I>> stage

◀
▼

6 5	A R S 0 1
T r p I > > >	

▼

[6504]
3rd: Trip signal given by the phase time overcurrent protection instantaneous I>>> stage

◀
▼

6 4	A R S 0 1
n o t a l l .	

▶
▼

[6501]
no further functions are preset for AR initiation

Following codeword input, all marshallable functions can be paged through the display by repeated use of the key Ⓜ. Back-paging is possible with the key Ⓜ. When the required function appears press the execute key E. After this, further functions can be allocated to the same AR input (with further index numbers 1 to 20) by using the key ▼. **Each selection must be confirmed by pressing the key E!** If a selection place shall not be assigned to a function, selection is made with the function "not all." (not allocated).

Leave the selection level with key ◀. You can go then to the next AR input with the arrow key ▼.

6 Operating instructions

6.1 Safety precautions



Warning

All safety precautions which apply for work in electrical installations are to be observed during tests and commissioning.



Caution!

Connection of the device to a battery charger without connected battery may cause impermissibly high voltages which damage the device. See also Section 3.1.1 under Technical data for limits.

6.2 Dialog with the relay

Setting, operation and interrogation of digital protection and automation systems can be carried out via the integrated membrane keyboard and display panel located on the front plate. All the necessary operating parameters can be entered and all the information can be read out from here. Operation is, additionally, possible via the interface socket by means of a personal computer or similar.

6.2.1 Membrane keyboard and display panel

Figure 6.1 illustrates the front view.

A two-line, each 8 character, liquid crystal display presents the information. Each character comprises a 5 x 8 dot matrix. Numbers, letters and a series of special symbols can be displayed.

During dialog, the upper line gives a two figure number. This number presents the **setting address block**.

The keyboard comprises 9 keys with paging, Yes/No and control buttons. The significance of the keys is explained in detail in the following:

Keys for alteration of numerical values and alternative texts:



increasing a value or text item



decreasing a value or text item

Yes/No keys:



Yes key: operator affirms the displayed question



No key: operator denies the displayed question; this key serves either as reset key for stored LED indicators and fault annunciations

Keys for scrolling and paging:



Scrolling forwards: the next display line or menu item is displayed



Scrolling backwards: the previous display line or menu item is displayed





Paging to the next operation level: the operation object of the next operating level is displayed



Paging to the previous operation level: the operation object of the previous operating level is displayed

Confirmation key:



Enter or confirmation key: each change via the "Yes"/"No"-keys or the  or  keys must be confirmed by the enter key; only then does the device accept the change. The enter key can also be used to acknowledge and clear a fault prompt in this display; a new input and repeated use of the enter key is then necessary.

Stored LED indications on the front and the fault annunciation buffer can be erased via the "No"-key **N**. During reset operation the assigned LEDs on the front will be illuminated thus performing a LED test. With this reset, additionally, the fault event indications in the display on the front panel of the device are acknowledged; the display shows then the operational values of the quiescent state.

6.2.2 Operation with a personal computer

A personal computer (with operating system MS WINDOWS) allows, just as the operator panel, all the appropriate settings, initiation of test routines and read-out of data, but with the added comfort of screen-based visualization and a menu-guided procedure. The PC program DIGSI® is available for setting and processing of all digital protection data.

All data can be read in from, or copied onto, magnetic data carrier (floppy disc) (e.g. for settings and configuration).

Additionally, all the data can be documented on a connected printer.

For operation of the personal computer, the instruction manuals of this device are to be observed. The PC program DIGSI® is available for setting and processing of all digital protection data. A survey of the suitable operating programs and further accessories is shown in Section 2.3 Ordering data.

6.2.3 Operational preconditions

For most operational functions, the input of a codeword is necessary. This applies for all entries via the membrane keyboard or interface which concern the operation on the relay, for example

- setting of functional parameters (thresholds, functions),
- allocation or marshalling of trip relays, signals, binary input, LED indicators,
- configuration parameters for operation language, interface and device configuration,
- initiation of test procedures.

The codeword is not required for the read-out of annunciations, operating data or fault data, or for the read-out of setting parameters.

The method of entry of the codeword is explained in detail in the installation instructions under Section 5.3.1.

6.2.4 Representation of the relay (front view)

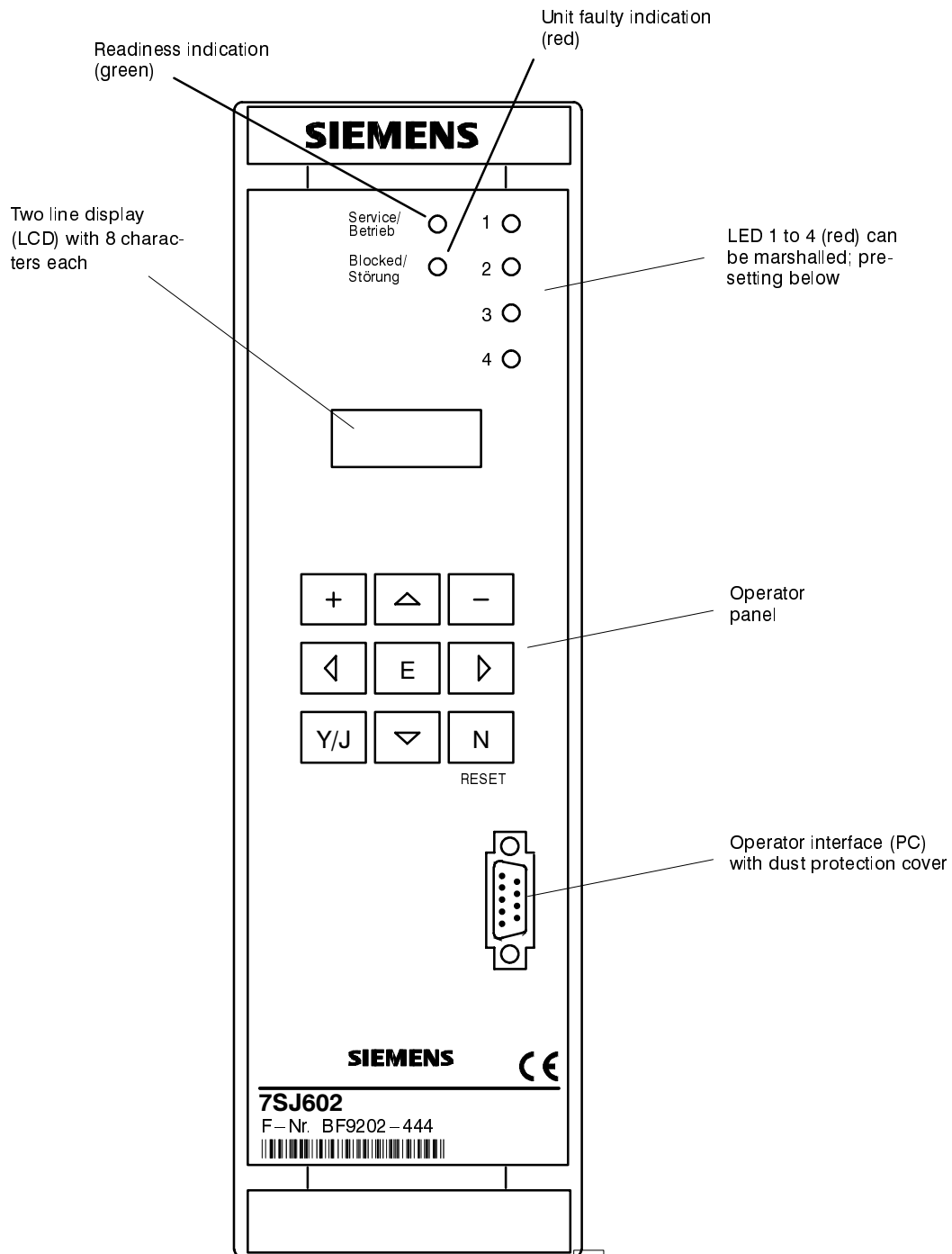

Factory presetting LEDs:

- 1 Fault L1
- 2 Fault L2
- 3 Fault L3
- 4 General trip

Figure 6.1 Front view of operating key board and display panel

6.3 Setting the functional parameters

6.3.1 Introduction

6.3.1.1 Parameterizing procedure

The operating surface is built up by a hierarchically structured menu tree, which can be passed through by means of the scrolling keys \triangleright , \triangleleft , ∇ , and Δ . Thus, each operation object can be reached. A complete overview is listed in Appendix C.

From the initial display, the key ∇ is used to switch to the first operation item "PARAME." (parameters) which contains all setting and configuration blocks of the device (see Figure 6.2). Key \triangleright is pressed to change to the next operation level. The display shows the first item "CONF." (configuration), which is described in Section 5.3 and 5.4.

Pressing the key ∇ leads to the first parameter block "01 POWER SYST.DAT" (power system data). Further parameter blocks can be called up with the scrolling keys ∇ or Δ .

The key \triangleright changes to the third operation level where the individual functions and values are set; refer to Figure 6.2. They are explained in detail in the following sections.

If no user operation has taken place for more than 10 Minutes, the relay terminates the setting mode and reverts to the default display, i.e. indication of the measured values. Alterations which have not yet been saved are lost. With the \triangleleft –key the last used operating level is reached.

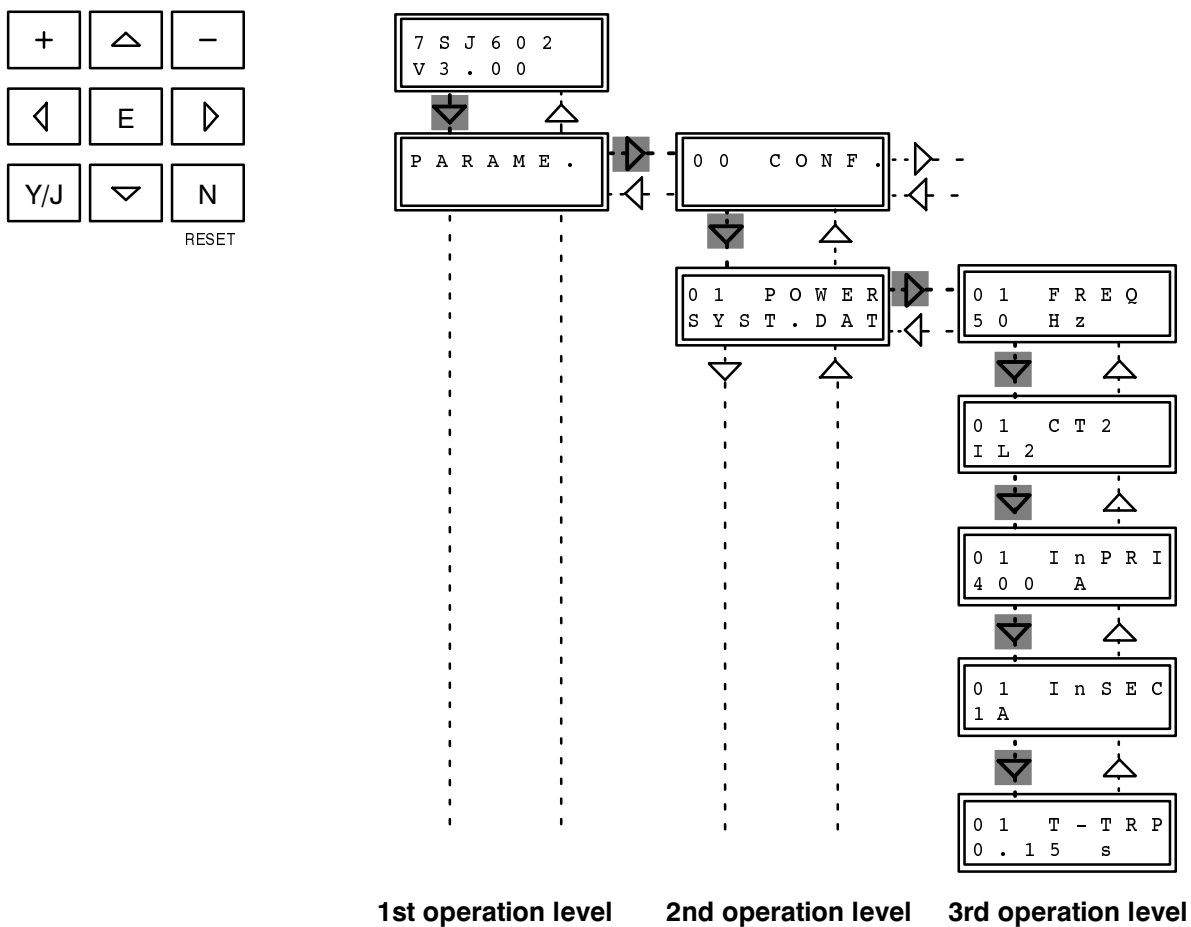

Figure 6.2 Selection of the power system data

For setting the functional parameters it is necessary to enter the codeword (see Section 5.3.1). Without codeword entry, parameters can be read out but not be changed.

If the codeword is accepted, parameterizing can begin. In the following sections each address is illustrated in a box and is explained. There are three forms of display:

– Addresses without request for operator input

Displayed text forms the heading of this address block. The address block is identified by the block number (two digit number). No input is expected. By using keys ∇ or Δ the next or the previous block can be selected. By using the key \triangleright the next operation level can be reached.

– Addresses which require numerical input

The display shows the two-digit block number in the first line. Behind the block number appears the meaning of the required parameter in abbreviated form, in the second display line, the value of the parameter. When the relay is delivered a value has been preset. In the following sections, this value is shown. If this value is to be retained, no other input is necessary. One can page forwards or backwards within the block or to the next (or previous) operation level. If the value needs to be altered, it can – after codeword input – be increased with the keys \oplus or decreased with the key \ominus . When one of the keys, \oplus or \ominus , is pressed continuously, the numbers will change with an accelerating sequence. Thus, a fast and fine adjustment is possible within a wide setting range. The permissible setting range is given in the following text, next to the associated box. When the highest possible value is reached, no further changing with the key \oplus is possible. The same is valid when one tries to change the lowest value with the key \ominus . **The selected value must be confirmed with the entry key E!** The display then confirms the accepted value. The changed parameter is effective after this confirmation.

– Addresses which require text input

The display shows the two-digit block number and the meaning of the required parameter and

in the second display line, the applicable text. When the relay is delivered, a text has been preset. In the following sections, this text is shown. If it is to be retained, no other input is necessary. One can page forwards or backwards within the block or to the next (or previous) operation level. If the text needs to be altered, press – after codeword input – the key \oplus (or \ominus). The next (or previous) alternative text, also printed in the display boxes illustrated in the following sections, then appears. If the alternative text is not desired, then the key \oplus (or \ominus) is pressed again, etc. The alternative which is chosen, **is confirmed with the entry key E.** When the last possible alternative is reached, no further changing with the key \oplus is possible. The same is valid when one tries to change the first alternative with the key \ominus .

For each of the addresses, the possible parameters and text are given in the following sections. If the meaning of a parameter is not clear, it is usually best to leave it at the factory setting. The arrows ∇ Δ or \triangleright \triangleleft besides the illustrated display boxes indicate the method of moving from block to block or within the block. Unused addresses are automatically passed over.

When the relay is operated from a personal computer by means of the protection data processing program DIGSI[®], each functional parameter is identified by a four-digit address number. In the following clarifications, this number is indicated at the beginning of the explanations in brackets.

If one tries to leave an operating item or operating level by pressing one of the arrow keys without having confirmed an alteration with the enter key **E**, the display will show the question "SAVE NEW SETTING?". Confirm with the "Yes" –key **Y/J** that the new settings shall become valid now. If you press the "No" –key **N** instead, codeword operation will be aborted, and the alteration which has been changed since the last entry is lost. Thus, erroneous alterations can be made ineffective. Press the arrow key once again in order to change really the operating item or level.

When the setting process is terminated by pressing the enter key **E**, the altered parameters are permanently secured in EEPROMs and protected against power outage.

6.3.1.2 Setting of date and time

The date and time should be set when the relay is finally installed and connected to the supply voltage.

From the initial display, the key ∇ is pressed (three times) until the menu item "ADDITION FUNCTION" ("additional functions") is displayed. Key \triangleright is pressed to change to the next operation level. The display shows the first item "TIME SETTING". Change to the third operation level with key \triangleright . The actual date and time is displayed now. Scroll on with key ∇ to find the setting items for date and time, as illustrated below.

After the relay has been switched on, first the date "01.01.95" appears and the time since the start-up of the processor system.

The next two addresses allow to set date and time. Codeword entry is not required. Day, month, and year can be altered using the keys \oplus and \ominus . Each time a value is changed, the enter key **E** must be pressed, before the next number can be changed. Proceed in analog manner to change the time.

Note: When the day is changed, the display firstly allows 31 days. Only when the month and year is changed, the relay can check plausibility of the complete date. After confirmation with the enter key **E**, the day may be reduced to an existing number.

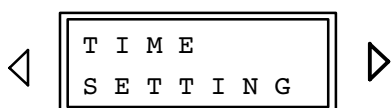

[8100]
Beginning of the block "Setting the real time clock"

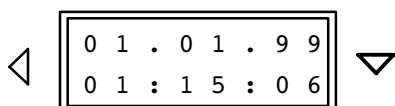

[8101]
At first, the "actual" date (**DD.MM.YY**) and the "actual" time (**HH.MM.SS**) are displayed.
Continue with ∇ .

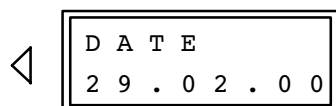

[8102]
Enter the new date: 2 digits for day, 2 digits for month and 2 digits for year: **DD** \triangleright **MM** \triangleright **YY**

Use key \oplus to increase the day or \ominus to decrease;
use key \triangleright to change over to the month;
use key \oplus to increase the month or \ominus to decrease;
use key \triangleright to change over to the year;
use key \oplus to increase the year or \ominus to decrease;
confirm with enter key **E**.



[8103]
Key ∇ is used to come to the time setting. Enter the new time: 2 digits for hour, 2 digits for minute: **HH** \triangleright **MM**

Use key \oplus to increase the hour or \ominus to decrease;
use key \triangleright to change over to the minute;
use key \oplus to increase the minute or \ominus to decrease;

the seconds are not changed. They are automatically set to "00" when the enter key **E** is pressed.

6.3.2 Initial display

When the relay is switched on, firstly the type identification of the relay and the version of the implemented firmware appears. All Siemens relays have an MLFB (machine readable order number). Approximately 30 s after the relay has been switched on, the display shows the quiescent messages, i.e. the measured values of the currents I_{L1} and I_{L2} . When the keys ∇ and subsequently Δ is pressed, the initial display is shown again.

7	S	J	6	0	2
V	3	.	*	*	

The relay introduces itself by giving its type number. The second display line shows the version of firmware with which it is equipped.

The setting parameters start at address block 01. This block is reached by pressing the key ∇ (refer also to Figure 6.2), with \triangleright to the second operation level ("00 CONFIG."), with ∇ to block "01 POWER SYST.DAT" (power system data). Further address possibilities are listed under "Annunciations" and "Tests".

6.3.3 Power system data – address block 01

The relay requests basic data of the power system and the switchgear.

\triangleleft	0 1 P O W E R	\triangleright	[1100]
	S Y S T . D A T		Beginning of the block "Power system data"

Firstly, the rated system frequency can be changed. It must comply with the setting. If the system frequency is not 50 Hz, the address must be changed.

\triangleleft	0 1 F R E Q	∇	[1101]
	5 0 H z		Rated system frequency 50 Hz or 60 Hz
+	6 0 H z		

The following rated currents do not affect the protection functions but are used only for scaling of the primary measured values and fault recording data:

\triangleleft	0 1 I n P R I	Δ	[1105]
	4 0 0 A	∇	Current transformer primary rated current
			Smallest setting value: 10 A
			Largest setting value: 50000 A

\triangleleft	0 1 I n S E C	Δ	[1106]
	1 A	∇	Current transformer secondary rated current
+	5 A		1 A or 5 A

The device provides four measured current inputs, three of which are connected to the current transformer set of the feeder. The following possibilities exist for the fourth input:

- Connection of the earth current from the star-point of the current transformers (standard circuit arrangement, see also Appendix B, Figure B.1):

Address 1110 is set as $I_e/I_{ph} = 1.000$

- Connection of the earth current from a separate earth current transformer (e.g. summation c.t., see also Appendix B, Figure B.3).

Address 1110 is set as

$$I_e/I_{ph} = \frac{\text{ratio of the earth current CT}}{\text{ratio of the phase current CT}}$$

Example:

Phase current transformers	500A/5A
Summation current transformer	300A/5A

$$I_e/I_{ph} = \frac{300/5}{500/5} = 0.600$$

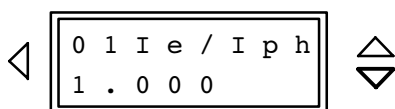

[1110]
 Matching factor I_e/I_{ph} for earth current
 Setting range: **0.010 to 5.000**

The minimum trip command duration T-TRP can be set. This is then valid for all protection functions of the device which can issue a trip signal. The close command duration T-CL is relevant if the relay is equipped with auto-reclosure. It must be long enough to ensure reliable closure of the circuit breaker. An excessively long time does not present any danger, since the closing command will be interrupted at once on renewed trip of any of the protection functions.

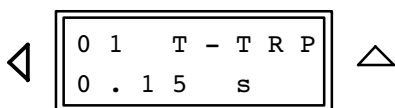

[1134]
 Minimum duration of the **trip** command
 Smallest setting value: **0.01 s**
 Largest setting value: **32.00 s**

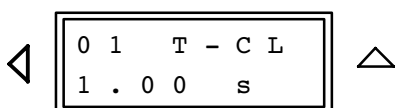

[1135]
 Maximum duration of the **close** command
 Smallest setting value: **0.01 s**
 Largest setting value: **60.00 s**

In order to come to the next address block, key \leftarrow is pressed to return to the previous operation level, and subsequently ∇ is pressed which will lead to the next address block 10. The individual parameters are listed in the next operation level.

6.3.4 Settings for phase fault time overcurrent protection – address block 10

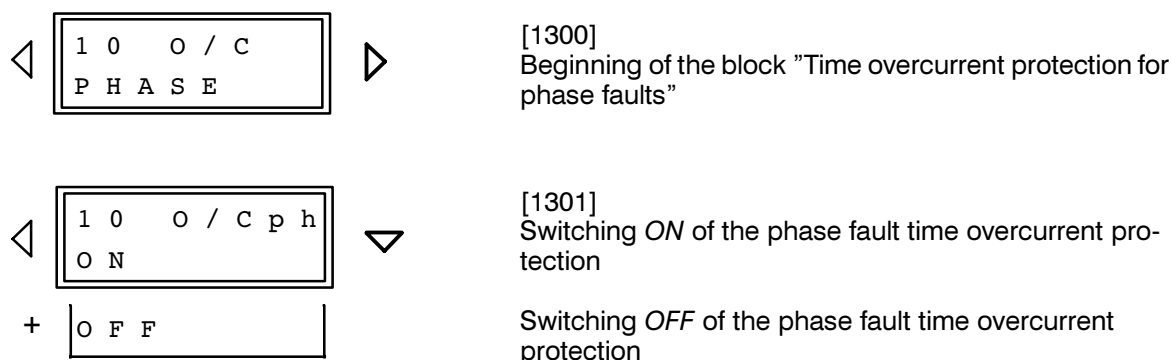

Dependent on the scope of functions of the relay (refer to Section 5.4.2), only those parameters are available which have a meaning for the selected functions. The settings for dynamic switch-over of pick-up values are only accessible when the dynamic switch-over had been configured as EXIST (Section 5.4.2).

If the dynamic switch-over facility is used and an adequate binary input has been assigned to this function, the duration T_{dyn} of this dynamic switch-over is set.

Then, the very high set and the high set overcurrent stages $I_{>>>}$ and $I_{>>}$, and – if appropriate – their dynamic thresholds $I_{>>>dy}$ and $I_{>>dy}$, are set. These stages are often used for current grading before high impedances, e.g. transformers.

They are set such that they pick up on short-circuits into the protected impedance, e.g. for transformers to 1.5 times of the value

$$\frac{I_{>>>}}{I_N} \approx \frac{I_{>>}}{I_N} \approx 1.5 \cdot \frac{1}{u_{K \text{ transf}}} \cdot \frac{I_{N \text{ transf}}}{I_{N \text{ c.t.}}}$$

In order to bridge out high inrush currents it may be advisable to set a short delay time for the $I_{>>}$ stage. Normally, 30 ms to 100 ms are sufficient.

For use on motors, it must be considered, that the high-set overcurrent element must not be exceeded by the motor start-up current, so that this stage does not trip the motor during start-up.







The very high instantaneous stage $I_{>>>}$ picks up on few instantaneous values of the current amplitude (converted to r.m.s. value). With short-circuit currents of more than 2 times setting value this stage operates immediately. Thus it should be set equal or higher than the high set stage $I_{>>}$. The $I_{>>>}$ stage

is always instantaneous, the $I_{>>}$ stage is always a definite time (or instantaneous) stage, independent on which characteristic is set for the overcurrent stage.

If the relay is intended to operate with auto-reclosure then the $I_{>>}$ and $I_{>>>}$ stage are used as rapid tripping stage before auto-reclosure: Before the first auto-reclosure, the $I_{>>}$ stage is valid without delay or with short-time delay, or the instantaneous $I_{>>>}$ stage, for the auto-reclosure sequence to be successful. After unsuccessful auto-reclosure, the $I_{>>}$ and $I_{>>>}$ stages are blocked. The delayed overcurrent stage $I_{>}$ (definite time) or I_p (inverse time) remains effective and, for reasons of selectivity, will clear the fault in accordance with the time grading plan of the network. The pick-up values of the $I_{>>}$ and $I_{>>>}$ stages need not be different from the overcurrent stage because it is the short tripping time of these stages which is of interest in this case. Note that these stages are blocked, in relays with auto-reclose function, after the first auto-reclosure. They can either be blocked via a binary input, together with blocking of the AR function (refer also to Section 5.5.2 Marshalling of the binary inputs).

A further application of the $I_{>>}$ stage is in conjunction with the reverse interlocking principle (as described in Section 4.2.4). The different tripping time is of interest in this case, too. The $I_{>>}$ stage is used for rapid tripping in case of a bus-bar fault, with only a short safety time. The overcurrent stage is the back-up for fault on an outgoing feeder.

The set times are pure delay times which do not include the operating time of the protection. If the high-set overcurrent stage $I_{>>>}$ or $I_{>>}$ are not used then set the pick-up values to ∞ . This is accomplished by pressing the key \oplus beyond the highest setting value.

<div style="border: 1px solid black; padding: 5px; display: inline-block;"> 1 0 T d y n 6 0 0 . 0 s </div>		<p>[1302] Duration of the dynamic switch-over of pick-up values; valid for phase as well as for earth currents Setting range: 0.1 s to 10000.0 s</p>
<div style="border: 1px solid black; padding: 5px; display: inline-block;"> 1 0 I > > > ∞ </div>		<p>[1303] Pick-up value of the very high set instantaneous stage I>>> for phase faults Setting range: 0.3 to 12.5 · I_N and ∞ (no trip with I>>> for phase faults)</p>
<div style="border: 1px solid black; padding: 5px; display: inline-block;"> 1 0 I > > > d y ∞ I n </div>		<p>[1304] Dynamic pick-up value of the very high set instantaneous stage I>>> (dyn) Setting range: 0.3 to 12.5 · I_N and ∞ (no trip with I>>>dyn)</p>
<div style="border: 1px solid black; padding: 5px; display: inline-block;"> 1 0 I > > 2 . 0 I n </div>		<p>[1305] Pick-up value of the high set stage I>> for phase faults Setting range: 0.1 to 25.0 · I_N and ∞ (no trip with I>> for phase faults)</p>
<div style="border: 1px solid black; padding: 5px; display: inline-block;"> 1 0 I > > d y 3 . 0 I n </div>		<p>[1306] Dynamic pick-up value of the high-set stage I>> (dyn) Setting range: 0.1 to 25.0 · I_N and ∞ (no trip with I>>dyn)</p>
<div style="border: 1px solid black; padding: 5px; display: inline-block;"> 1 0 T I > > 0 . 0 3 s </div>		<p>[1307] Trip time delay of the high-set stage I>> Setting range: 0.00 s to 60.00 s</p>

The overcurrent stage can be used as definite time overcurrent protection or inverse time overcurrent protection or both at the same time. A choice can be made whether the inverse time characteristics meet the IEC standards or the ANSI standards. This function mode has been preselected during configuration in Section 5.4.2. In this block 10, only those parameters are available which are associated with the preselected function mode.

If a definite time the function mode is chosen, i.e. "def TIME" or "IEC O/C" or "ANSI O/C", the following setting parameters are presented. The maximum load current determines the setting of the overcurrent stage I>. Pick-up on overload must be excluded since the unit operates in this mode as short circuit protection with adequate short tripping time and not

as overload protection. Therefore, the overcurrent stage is set to 120 % for feeder lines, and 150 % for transformers or motors referred to maximum (over)load current.

For use on motors, it must be considered, that the motor takes increased start-up current. Either the overcurrent stage must be set accordingly high, or the dynamic stage I>dy must be used during start-up. This stage must then be set above the start-up current; furthermore, the relay must be switched over to the dynamic stage via a binary input as long as the motor is starting.

The time delay TI> depends on the grading plan for the network. If the overcurrent stage I> is not used then set the pick-up value I> to ∞.

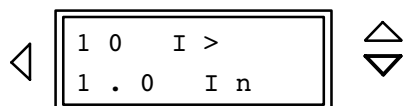

[1308]

For definite time overcurrent protection only (def TIME, IEC O/C, ANSI O/C):

Pick-up value of the overcurrent stage I> for phase faults

Setting range: **0.1 to 25.0** · I_N

and ∞ (no trip with I> for phase faults)

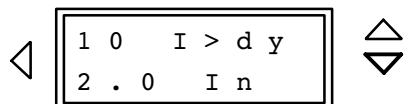

[1309]

For definite time overcurrent protection only (def TIME, IEC O/C, ANSI O/C):

Dynamic pick-up value of the overcurrent stage I> (dyn)

Setting range: **0.1 to 25.0** · I_N

and ∞ (no trip with I>dyn)

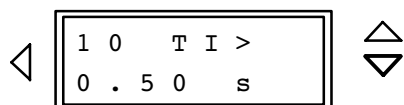

[1310]

For definite time overcurrent protection only (def TIME, IEC O/C, ANSI O/C):

Trip time delay for the overcurrent stage I>

Setting range: **0.00 s to 60.00 s**

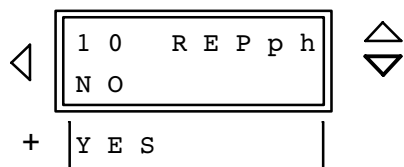

[1311]

Measurement repetition for all phase current stages except the I>>> and I>>>dyn stage; normal setting: NO

With setting YES the operating time is increased by approx. 10 ms

If the function mode is "IECinv" or "IEC O/C", one of four inverse time characteristics defined in IEC 60255–3 can be selected. It must be considered that, according to IEC 60255–3, the protection picks up only when at least 1.1 times the set value is exceeded.

If the overcurrent stage I_p is not used then set "never" as characteristic for phase currents.

For use on motors, it must be considered, that the motor takes increased start-up current. Either the overcurrent stage must be set accordingly high, or the dynamic stage I_p dy must be used during start-up. This stage must then be set above the start-up current; furthermore, the relay must be switched over to the dynamic stage via a binary input as long as the motor is starting.

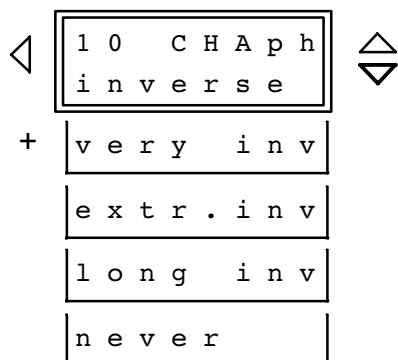

[1312]

For "IEC inv." or "IEC O/C" only: Characteristic of the overcurrent stage I_p for phase faults, can be normal *inverse* time lag (IEC 60255–3 type A)

very inverse time lag (IEC 60255–3 type B)

extremely inverse time lag (IEC 60255–3 type C)

long inverse time lag (IEC 60255–3 type B)

I_p stages for phase currents operate *never*

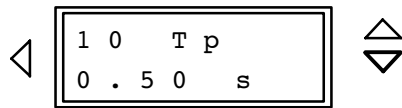

[1313]
For "IEC inv." or "IEC O/C" only:
 Time multiplier for the inverse time overcurrent stage I_p for phase currents
 Setting range: **0.05 s to 3.20 s**

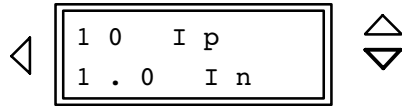

[1316]
For "IEC inv." or "IEC O/C" only:
 Pick-up value of the inverse time overcurrent stage I_p for phase currents
 Setting range: **0.1 to 4.0 · I_N**

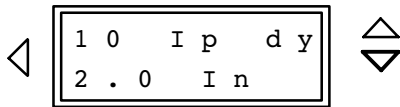

[1317]
For "IEC inv." or "IEC O/C" only:
 Dynamic pick-up value of inverse time O/C stage I_p (dyn)
 Setting range: **0.1 to 4.0 · I_N**

If the function mode is "ANSI inv" or "ANSI O/C", one of the following eight inverse time characteristics can be selected.

It must be considered that, according to ANSI/IEEE, the protection picks up only when at least 1.06 times the set value is exceeded.

If the overcurrent stage I_p is not used then set "never" as characteristic for phase currents.

For use on motors, it must be considered, that the motor takes increased start-up current. Either the overcurrent stage must be set accordingly high, or the dynamic stage $I_{>dy}$ must be used during start-up. This stage must then be set above the start-up current; furthermore, the relay must be switched over to the dynamic stage via a binary input as long as the motor is starting.

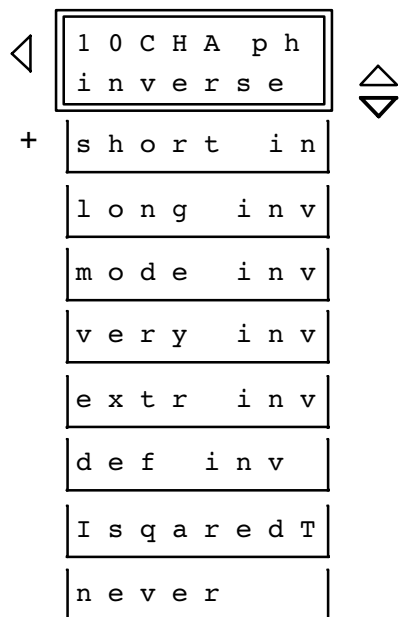

[1314]
For "ANSI O/C" or "ANSI inv":
 Characteristic for phase faults, can be
 normal *inverse* time lag acc. ANSI/IEEE
short inverse time lag acc. ANSI/IEEE
long inverse time lag acc. ANSI/IEEE
moderately inverse time lag acc. ANSI/IEEE
very inverse time lag acc. ANSI/IEEE
extremely inverse time lag acc. ANSI/IEEE
definite inverse time lag acc. ANSI/IEEE
I-squared-T
 I_p stages for phase currents operate *never*

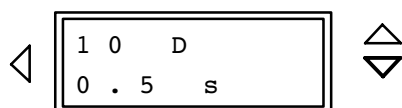

[1315]

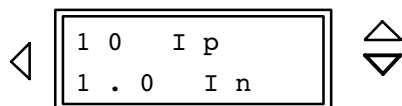
For "ANSI O/C" or "ANSI inv":Time multiplier for the inverse time overcurrent stage I_p for phase currentsSetting range: **0.5 s to 15.0 s**

[1316]

For "ANSI O/C" or "ANSI inv":Pick-up value of the inverse time overcurrent stage I_p for phase currentsSetting range: **0.1 to 4.0 · I_N** 

[1317]

For "ANSI O/C" or "ANSI inv":Dynamic pick-up value of inverse time O/C stage I_p (dyn)Setting range: **0.1 to 4.0 · I_N**

When the definite time characteristic is chosen, the fundamental waves of the measured currents are evaluated for pick-up. When one of the **inverse time** characteristic is chosen, a choice can be made whether the fundamental waves of the measured currents are evaluated, or if the true r.m.s. values including harmonics and d.c. component are calcu-

lated for evaluation. As the relay is used as short-circuit protection, the preset value is recommended. If the time grading is to be coordinated with conventional relays which operate with true r.m.s. values, then the evaluation with harmonics and d.c. component may be advantageous.



[1318]

For inverse time overcurrent protection only:

The fundamental waves of the measured currents are evaluated

The true r.m.s. values of the measured currents are evaluated

The next parameter in address block 10 determines which stage is effective when the circuit breaker is manually closed. A pre-requisite is, that the manual close command for the breaker is repeated via a

binary input to the relay 7SJ602 so that it is informed about manual closing of the breaker. *INEFFECTIVE* means that the stages operate according to the settings.

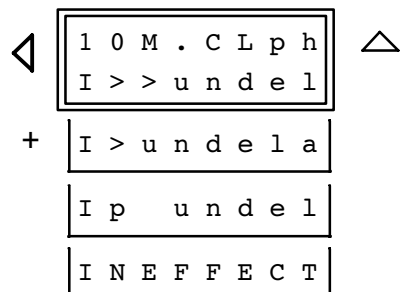

[1319]

Phase overcurrent stage which is effective during manual closing of the circuit breaker:

 $I > >$ i.e. $I > >$ stage but *undelayed* $I >$ i.e. $I >$ stage (definite time), but *undelayed* I_p i.e. I_p stage (inverse time), but *undelayed**INEFFECTIVE*, i.e. stages operate as parameterized

6.3.5 Settings for earth fault time overcurrent protection – address block 11

◀	1 1 O / C E A R T H	▶	[1400] Beginning of the block "Time overcurrent protection for earth faults"
◀	1 1 O / C e O N	▼	[1401] Switching ON of the earth fault time overcurrent protection
+	O F F		Switching OFF of the earth fault time overcurrent protection

Dependent on the scope of functions of the relay (refer to Section 5.4.2), only those parameters are available which have a meaning for the selected functions. The settings for dynamic switch-over of pick-up values are only accessible when the dynamic switch-over had been configured as *EXIST* (Section 5.4.2).

If the dynamic switch-over facility is used and an adequate binary input has been assigned to this function, the appropriate threshold values are set. The

duration of the dynamic switch-over is the same as set for phase currents (Section 6.3.4).

The high-set overcurrent stage $I_{E>>}$ is set, if used; if not used, set $I_{E>>}$ to ∞ . For determination of the setting values similar considerations are valid as for the phase fault stage $I>>$ (refer Section 6.3.4). Blocking of the $I_{E>>}$ stage after unsuccessful AR is valid as with the $I>>$ stage.

◀	1 1 I E >> 0 . 5 0 I n	△ ▽	[1402] Pick-up value of the high-set stage $I_{E>>}$ for earth faults Setting range: 0.05 to 25.00 · I_N and ∞ (no trip with $I_{E>>}$ for earth faults)
◀	1 1 I E >> d y 0 . 5 0 I n	△ ▽	[1403] Dynamic pick-up value of the high-set stage $I_{E>>}$ (dyn) for earth current Setting range: 0.05 to 25.00 · I_N and ∞ (no trip with $I_{E>>}$ dyn)
◀	1 1 T I E >> 0 . 1 0 s	△ ▽	[1404] Trip time delay of the high-set stage $I_{E>>}$ Setting range: 0.00 s to 60.00 s

The earth current stage can be used as definite time overcurrent protection or inverse time overcurrent protection or both at the same time, independent on the phase current stage.

If a definite time the function mode is chosen, i.e. "def TIME" or "IEC O/C" or "ANSI O/C", the following setting parameters are presented. For earth faults, all parameters of the time overcurrent protection can

be set separately and independently. This allows separate time grading for earth faults with e.g. shorter times. The minimum earth fault current determines the setting of the overcurrent stage $I_{E>}$.

The time delay $TIE>$ depends on the grading plan for the network.

If the overcurrent stage $I_{E>}$ is not used then set the pick-up value $I_{E>}$ to ∞ .

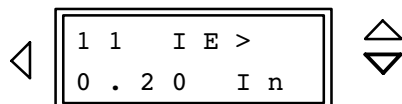

[1405]

For definite time overcurrent protection only (def TIME, IEC O/C, ANSI O/C):

Pick-up value of the overcurrent stage $I_{E>}$ for earth faults

Setting range: **0.05 to 25.00** · I_N

and ∞ (no trip with $I_{E>}$ for earth faults)

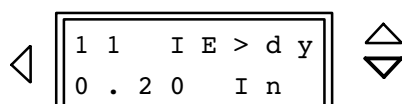

[1406]

For definite time overcurrent protection only (def TIME, IEC O/C, ANSI O/C):

Dynamic pick-up value of the stage $I_{E>}$ (dyn)

Setting range: **0.05 to 25.00** · I_N

and ∞ (no trip with $I_{E>}$ dyn)

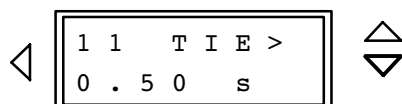

[1407]

For definite time overcurrent protection only (def TIME, IEC O/C, ANSI O/C):

Trip time delay for the overcurrent stage $I_{E>}$

Setting range: **0.00 s to 60.00 s**

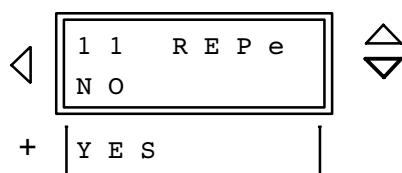

[1408]

Measurement repetition for all earth current stages; normal setting: *NO*

With setting *YES* the operating time is increased by approx. 10 ms

If the function mode is "*IECinv*" or "*IEC O/C*", one of four inverse time characteristics defined in IEC 60255–3 can be selected. It must be considered that, according to IEC 60255–3, the protection picks up only when at least 1.1 times the set value is exceeded.

rent protection can be set separately and independently. This allows separate time grading for earth faults with e.g. shorter times. The minimum earth fault current determines the setting of the overcurrent stage I_{Ep} .

For earth faults, all parameters of the time overcur-

If the overcurrent stage I_{Ep} is not used then set "*never*" as characteristic for earth current.

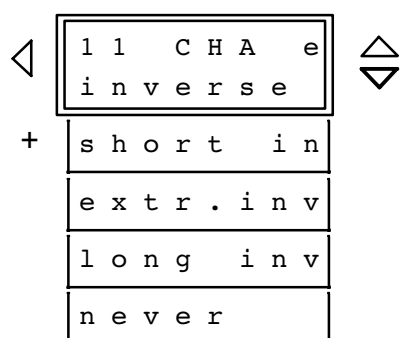

[1409]

For inverse time overcurrent protection "IEC O/C" or "IEC inv" only: Characteristic of the overcurrent stage I_{Ep} for earth faults, can be

normal *inverse* time lag (IEC 60255–3 type A)

short inverse time lag (IEC 60255–3 type B)

extremely inverse time lag (IEC 60255–3 type C)

long inverse time lag (IEC 60255–3 type B)

I_{Ep} stage for earth current operates *never*



[1410]
For inverse time overcurrent protection "IEC O/C" or "IEC inv" only:
 Time multiplier for the inverse time overcurrent stage I_{Ep} for earth current
 Setting range: **0.05 s to 3.20 s**



[1413]
For inverse time overcurrent protection "IEC O/C" or "IEC inv" only:
 Pick-up value of the inverse time overcurrent stage I_{Ep} for earth current
 Setting range: **0.05 to 4.00 · I_N**

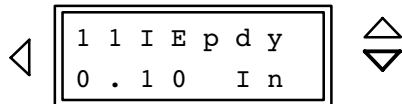

[1414]
For inverse time overcurrent protection "IEC O/C" or "IEC inv" only:
 Dynamic pick-up value of inverse time O/C stage I_{Ep} (dyn)
 Setting range: **0.05 to 4.00 · I_N**

If the function mode is "ANSIinv" or "ANSI O/C", one of the following eight inverse time characteristics can be selected. It must be considered that, according to ANSI/IEEE, the protection picks up only when

at least 1.06 times the set value is exceeded.

If the overcurrent stage I_{Ep} is not used then set "never" as inverse time characteristic for earth current.

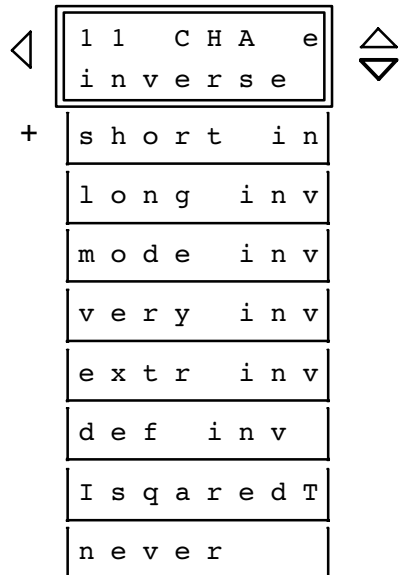

[1411]
For inverse time overcurrent protection "ANSI O/C" or "ANSI inv" only:
 Characteristic for earth faults, can be
 normal *inverse* time lag acc. ANSI/IEEE
 short *inverse* time lag acc. ANSI/IEEE
 long *inverse* time lag acc. ANSI/IEEE
 moderately *inverse* time lag acc. ANSI/IEEE
 very *inverse* time lag acc. ANSI/IEEE
 extremely *inverse* time lag acc. ANSI/IEEE
 definite *inverse* time lag acc. ANSI/IEEE
I-squared-T
 I_{Ep} stage for earth current operates *never*



[1412]
For inverse time overcurrent protection "ANSI O/C" or "ANSI inv" only:
 Time multiplier for the inverse time overcurrent stage I_{Ep}
 Setting range: **0.5 s to 15.0 s**



[1413]
For inverse time overcurrent protection "ANSI O/C" or "ANSI inv" only:
 Pick-up value of the inverse time overcurrent stage I_{Ep} for earth faults
 Setting range: **0.05 to 4.00** · I_N

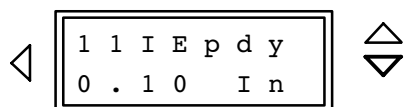

[1414]
For inverse time overcurrent protection "ANSI O/C" or "ANSI inv" only:
 Dynamic pick-up value of inverse time O/C stage I_{Ep} (dyn)
 Setting range: **0.05 to 4.00** · I_N

When the definite time characteristic is chosen, the fundamental waves of the measured currents are evaluated for pick-up. When one of the **inverse time** characteristic is chosen, a choice can be made whether the fundamental waves of the measured currents are evaluated, or if the true r.m.s. values including harmonics and d.c. component are calcu-

lated for evaluation. As the relay is used as short-circuit protection, the preset value is recommended. If the time grading is to be coordinated with conventional relays which operate with true r.m.s. values, then the evaluation with harmonics and d.c. component may be advantageous.



[1415]
For inverse time overcurrent protection only:
 The fundamental waves of the measured currents are evaluated
 The true r.m.s. values of the measured currents are evaluated

The next parameter in address block 11 determines which stage is effective if the circuit breaker is manually closed. A pre-requisite is, that the manual close command for the breaker is repeated via a binary in-

put to the relay 7SJ602 so that it is informed about manual closing of the breaker. *INEFFECTIVE* means that the stages operate according to the settings.

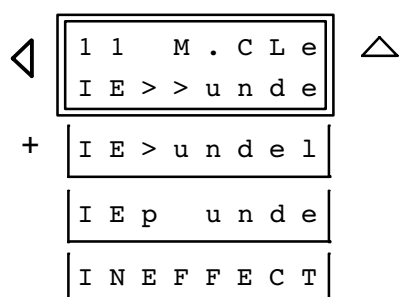

[1416]
 Earth overcurrent stage which is effective during manual closing of the circuit breaker:
 $I_{E>>}$ i.e. $I_{E>>}$ stage but undelayed
 $E>$ i.e. $I_{E>}$ stage (definite time), but undelayed
 I_{Ep} i.e. I_{Ep} stage (inverse time), but *undelayed*
INEFFECTIVE, i.e. stages operate as parameterized

6.3.6 Settings for unbalanced load protection – address block 24

The relay includes an unbalanced load protection (refer to Section 4.3). This can operate only when it is configured to UNB. L = *EXIST* under address block 00 during configuration of the device functions (refer to Section 5.4.2).

The unbalanced load protection can be set to be in-operative or operative.

The preset values are adequate for most motors. If limit values have been stated by the manufacturer, these should be preferred.

◁	2 4 U N B A L L O A D	▷	[1500] Beginning of the block "Unbalanced load protection"
---	------------------------------	---	---

◁	2 4 U N B . L O N	▽	[1501] Switch <i>ON</i> of unbalanced load protection
+	O F F		Switch <i>OFF</i> of unbalanced load protection

◁	2 4 I 2 > 1 0 %	△ ▽	[1502] Pick-up value for stage $I_{2>}$ Setting range: 8 % to 80 % (referred to rated current of the relay I_N)
---	------------------------	--------	--

◁	2 4 T I 2 > 5 . 0 0 s	△ ▽	[1503] Time delay for stage $I_{2>}$ Setting range : 0.00 s to 60.00 s
---	------------------------------	--------	--

◁	2 4 I 2 >> 5 0 %	△ ▽	[1504] Pick-up value for stage $I_{2>>}$ Setting range: 8 % to 80 % (referred to rated current of the relay I_N)
---	-------------------------	--------	---

◁	2 4 T I 2 >> 1 . 0 0 s	△	[1505] Time delay for stage $I_{2>>}$ Setting range : 0.00 s to 60.00 s
---	-------------------------------	---	---

6.3.7 Settings for thermal overload protection – address block 27

The relay includes a thermal overload protection (refer to Section 4.4). This can operate only when it is configured (refer Section 5.4.2) either as overload protection with total memory ("preLOAD") or without memory ("no preLD"), and when it is switched "ON". Dependent on the configuration, only the parameters associated with the corresponding function are available.

When the thermal overload function with total memory is selected, all load cycles of the protected object are evaluated in a thermal replica. Thus, the relay can be adapted optimally to the protected object. When the overload function without memory is selected, then only those currents are evaluated, which exceed 1.1 times the set threshold value. Currents below this value are ignored.

Cables, transformers, and electrical machines are particularly endangered by overloads of longer duration. These overloads cannot and should not be detected by the short-circuit protection. The time overcurrent protection, for example, must be set sufficiently high so as to only detect short-circuits. Only short delays are permitted for short-circuit protection. These short time delays, however, do not permit measures to unload the overloaded object nor to utilize its (limited) overload capacity.

This function is usually not required for overhead lines as the current carrying capacity of overhead lines is generally not defined.

The overload protection function can be set to be inoperative or to initiate tripping (including alarm).

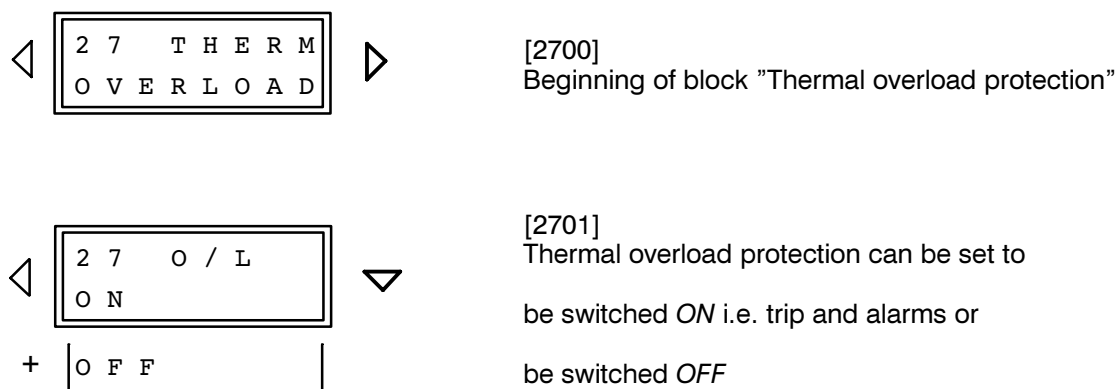

6.3.7.1 Overload protection with total memory

The rated current of the device is used as the base current for the overload measurement. The setting factor k is determined by the ratio of the continuously permissible thermal current I_{max} to the rated current:

$$k = \frac{I_{max}}{I_N} \quad \text{where } k = \text{factor acc. IEC 60255-8 or VDE 0435 part 303}$$

The permissible continuous current depends on cross-section, insulation material, type of construction and method of installation of the cable, etc. In general, the magnitude of the current can be taken

from widely available tables or otherwise is to be stated by the manufacturer.

Since the rated current of the protected object (e.g. motor) is rarely identical with the rated current of the current transformers, the ratio

$$\frac{I_{N \text{ mach}}}{I_{N \text{ pri}}}$$

must be considered when the maximum current I_{max} is determined:

$$k = \frac{I_{max \text{ mach}}}{I_{N \text{ mach}}} \cdot \frac{I_{N \text{ mach}}}{I_{N \text{ pri}}} = \frac{I_{max \text{ mach}}}{I_{N \text{ pri}}}$$

The heating-up time constant τ depends on the cable data and the cable surroundings or the motor data. If the time constant is not readily available, it can be calculated from the short-term overload capacity. Frequently, the 1 s current, i.e. the maximum permissible current for 1 s duration, is known or can be taken from tables. The time constant can then be calculated according to the following formula:

Setting value τ [min] =

$$\frac{1}{60} \cdot \left(\frac{\text{permissible 1 s current}}{\text{continuously permissible current}} \right)^2$$

If the short-time overload capacity is stated for a duration other than 1 s, then that short-term current is inserted into the above formula instead of the 1 s current. However, the result is then multiplied with the

stated duration, i.e. in case of an 0.5 s current:

$$\frac{0.5}{60} \cdot \left(\frac{\text{permissible 0.5 s current}}{\text{continuously permissible current}} \right)^2$$

It should be noted that the result becomes more inaccurate the longer the stated duration of the current becomes.

For motors, often the t_6 -time is given instead of the thermal time constant; that is the time for which a current of 6 times rated current of the motor is permissible. The time constant can then be approximated by the equation:

$$\text{Setting value } \tau \text{ [min]} = \frac{t_6/\text{s}}{60} \cdot 36 = 0.6 \cdot t_6/\text{s}$$

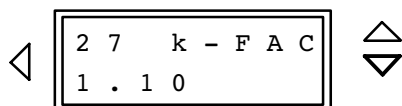

[2702]

Setting value of k-factor = I_{\max}/I_N
Setting range: **0.40 to 2.00**

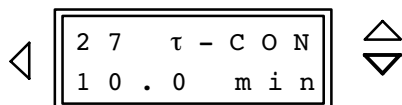

[2703]

Time constant τ
Setting range: **1.0 to 999.9 min**

When the motor is at stand-still, the cooling-down time constant may strongly differ from the heating-up time constant, if the motor is self-ventilated. This can be taken into account by the following parameter, which represents the factor how much times the cooling-down time constant exceeds the heating-up time constant, i.e.

$$\text{Setting value } f - T_{co} = \frac{\tau_{\text{cooling down}}}{\tau_{\text{heating up}}}$$

The criterion that the motor is at stand-still is that all currents are smaller than 0.1 times rated current.

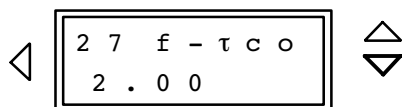

[2704]

Prolongation factor of the time constant at stand-still referred to the time constant during running
Setting range: **1.00 to 10.00**

By setting a warning temperature rise, an alarm can be output before the trip temperature rise is

reached, so that, for example, by prompt load shedding tripping may be prevented.

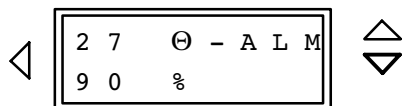

[2705]

Thermal warning stage, in % of trip temperature rise $\Theta_{\text{warn}}/\Theta_{\text{trip}}$
Setting range: **50 % to 99 %**

6.3.7.2 Overload protection without memory

The criterion for overload for overload protection without memory is that an adjustable limit value is exceeded. This threshold is 1.1 times the set value I_L where I_L is the permissible load current, normally the rated current of the protected object. The applied formula, as given in Section 3.5.2 is, nevertheless, based on one times the current I_L . Thus, as the safety factor 1.1 for pick-up is already considered in the relay, the recommended setting value for I_L is:

$$\text{Setting value} \quad \frac{I_L}{I_{N \text{ Device}}} = \frac{I_{N \text{ mach}}}{I_{N \text{ pri}}}$$

The time multiplier t_L must be set in accordance with the thermal capability of the protected object. It represents the so-called t_6 -time, i.e. the tripping time when 6 times the base current I_L is flowing; this is often stated by the motor manufacturer. If the heating-up time constant is stated instead of the t_6 -time, then the latter (and thus the setting value t_L) can be approximated by the following equation:

$$\frac{t_6}{s} = \frac{1}{36} \frac{\tau}{s}$$

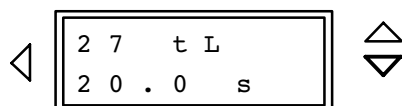

[2706]
Time multiplier t_L for overload stage without memory
Setting range: **1.0 s to 120.0 s**

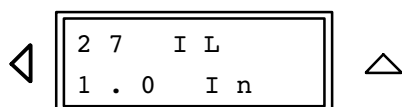

[2707]
Base value I_L for overload stage without memory (pick-up at 1.1 times I_L)
Setting range: **0.4 to 4.0 · I_N**

6.3.8 Settings for start-up time monitoring – address block 28

The device incorporates a start-up time monitor (refer to Section 4.5), which represents a useful supplement in case of motors. This function can operate only when it is configured as "EXIST" (refer to Section 5.4.2) and switched "ON" in address block 28.

The start-up criterion is the increased current that the motor takes during start-up. Consequently, the critical current value I_{strt} must be set such that it is exceeded by the start-up current under all load and voltage conditions. On the other hand, this value must not be exceeded by permissible short-term overloads.

The tripping time T_{strt} must be coordinated with the motor such, that the motor is not thermally endangered during this time. On the other hand, it must be long enough that the motor has terminated the start-up period under normal, healthy conditions. When this time is exceeded, it is assumed that the rotor is locked, so that ventilation may be reduced.

Calculation example:

Motor	rated current	$I_N = 115 \text{ A}$
	start-up current	$I_{start} = 575 \text{ A}$
	start-up time	$T_{start} = 10 \text{ s}$
Current transformers		
150 A / 5 A		

For safety reasons, the start-up time monitor is set to approximately half the start-up current, i.e. 288 A. In secondary referred value:

$$\text{Setting } I_{strt} = \left(\frac{288 \text{ A}}{150 \text{ A}} \right) = 1.92$$

The parameter T_{strt} is calculated according the following equation which is derived from the protection characteristic:

$$\text{Setting } T_{strt} = t_{start} \cdot \left(\frac{I_{rms}}{I_{strt}} \right)^2$$

For the given example results:

$$\text{Setting } T_{strt} = 10 \text{ s} \cdot \left(\frac{575}{288} \right)^2 = 40 \text{ s}$$

Thus, tripping at rated start-up current will occur after approximately 10 s.

Note: The thermal characteristics of the overload protection (with or without memory) are effective even during start-up of the motor.

Address 2804 determines whether the overcurrent stage of the time overcurrent protection ($I >$ stage and/or I_p stage, dependent on configuration) should be blocked during start-up of a motor.

◁	<table border="1"><tr><td>2 8</td><td>S T A R T</td></tr><tr><td>T I M E</td><td>S U P</td></tr></table>	2 8	S T A R T	T I M E	S U P	▷	[2800] Beginning of the block "Supervision of start-up time"
2 8	S T A R T						
T I M E	S U P						
◁	<table border="1"><tr><td>2 8</td><td>S T R T</td></tr><tr><td>O N</td><td></td></tr></table>	2 8	S T R T	O N		▽	[2801] Switching ON the supervision of start-up time
2 8	S T R T						
O N							
+	<table border="1"><tr><td>O F F</td><td></td></tr></table>	O F F			Switching OFF the supervision of start-up time		
O F F							
◁	<table border="1"><tr><td>2 8</td><td>t s t r t</td></tr><tr><td>1 0 . 0</td><td>s</td></tr></table>	2 8	t s t r t	1 0 . 0	s	◁	[2802] Setting value of the permissible start-up time T_{strt} at I_{strt} Setting range: 1.0 s to 360.0 s
2 8	t s t r t						
1 0 . 0	s						

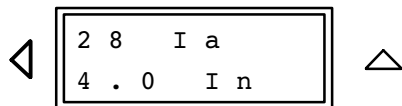

[2803]
Base value I_{strt} of the permissible start-up current
Setting range: **0.4 · I_N to 20.0 · I_N**

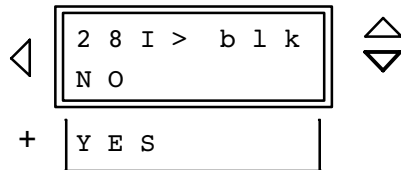

[2804]
Blocking of the I>/I_p stages during motor start-up

6.3.9 Settings for measured value supervision – address block 29

The sensitivity of the measured value monitoring can be changed in block 29. The factory settings are suitable in most cases.

If, during operation, the monitoring function reacts sporadically, then sensitivity should be reduced.

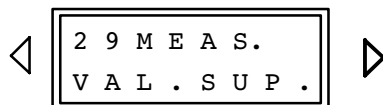

[2900]
Beginning of the block "Current symmetry supervision"

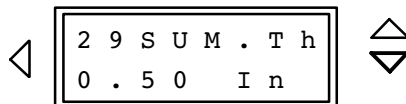

[2901]
Current threshold above which the sum monitoring is effective (see Figure 4.14)
Setting range: **0.05 I_N to 2.00 I_N**

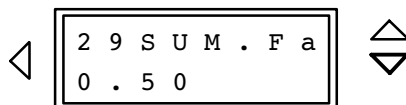

[2902]
Sum factor for the current sum = slope of the sum characteristic (see Figure 4.14)
Setting range: **0.00 to 0.95**

6.3.10 Settings for auto-reclosure – address block 34

Auto-reclose function is effective only if it is incorporated in the relay and configured as *EXIST* (refer to Section 5.4.2).

When no auto-reclosure is to be carried out on the feeder which is protected by the time overcurrent protection (e.g. cables, transformers, motors, etc.), then the internal AR function must be configured as *nonEXIST* (refer to Section 5.4.2). The AR function is then not effective at all, i.e. 7SJ602 does not process the AR function. No corresponding annunciations are given, binary inputs for auto-reclosure are ignored. All parameters in block 34 are irrelevant and unavailable.

7SJ602 allows up to nine auto-reclose attempts to be carried out. The number of desired auto-reclosure attempts is set as ARcnt.

The dead times can be separately and individually set for the first three auto-reclosure cycles (AR T1, AR T2, and AR T3). If further auto-reclosure attempts are required, they operate with the dead time AR T4. The duration of the dead times is determined by the application philosophy. For longer lines it should be long enough to ensure that the fault arc is extinguished and the air surrounding the arc is de-ionized, so that auto-reclosure can be successful. (0.6 s to 1.0 s). With multiple-end fed lines the stability of the network is the important consideration. Since the disconnected line can no longer produce any synchronizing power, only a short dead time is per-

mitted in most cases. Conventional values lie between 0.3 s and 0.6 s. In radial networks, longer dead times can be tolerated.









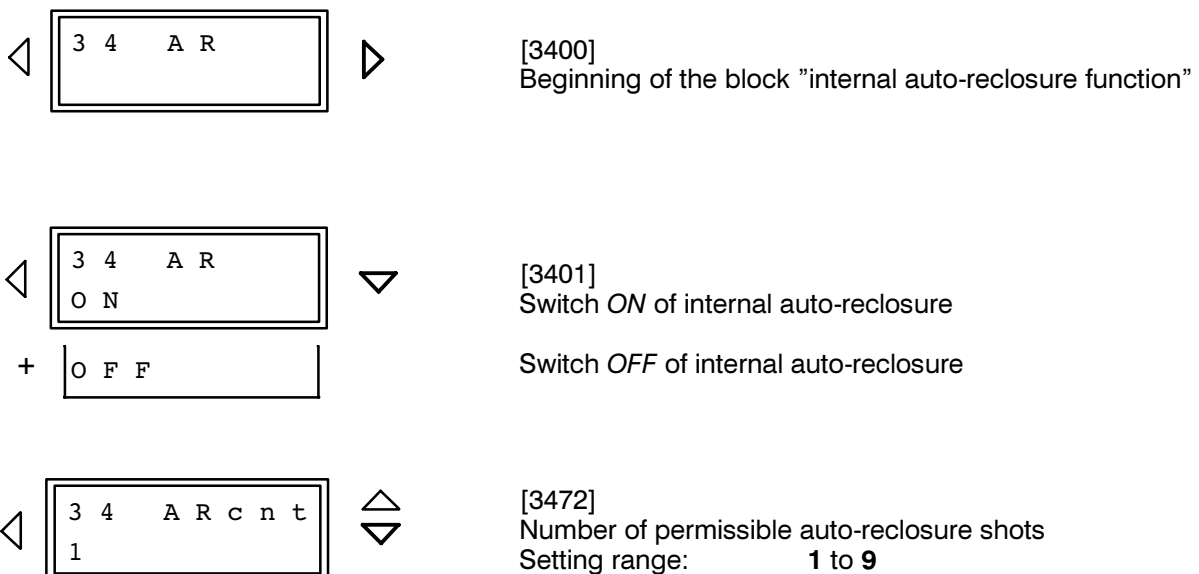





The reclaim time T-REC is the time period after which the network fault is supposed to be terminated after a successful auto-reclose cycle. A renewed AR initiation within this time increments the AR counter (when multi-shot AR is used) so that the next AR cycle starts; if no further AR is allowed the last AR is treated as unsuccessful. The reclaim time must be set longer than the expected time for a renewed initiation condition of a persistent fault, i.e. normally longer than the maximum trip time of the time overcurrent protection.

The lock-out time T-LOC is the time period during which after an unsuccessful auto-reclosure further reclosures by 7SJ602 are locked. This time must be longer than the renewed readiness for operation of the circuit breaker.

The blocking time after manual closure of the breaker T-BLM must cover the time for safe closing and opening of the circuit breaker (0.5 s to 1 s). If a renewed initiation condition appears within this time, definitive trip command is issued and reclosure is blocked.

The duration of the closing command has already been set when setting the general parameters of the device (see Section 6.3.3).



 <div style="border: 1px solid black; padding: 5px; display: inline-block;"> 3 4 A R T 1 0 . 1 0 s </div> 	<p>[3465] Dead time for the first auto-reclose cycle Setting range: 0.05 s to 1800.00 s</p>
 <div style="border: 1px solid black; padding: 5px; display: inline-block;"> 3 4 A R T 2 0 . 1 0 s </div> 	<p>[3466] Dead time for the second auto-reclose cycle, if used Setting range: 0.05 s to 1800.00 s</p>
 <div style="border: 1px solid black; padding: 5px; display: inline-block;"> 3 4 A R T 3 0 . 1 0 s </div> 	<p>[3467] Dead time for the third auto-reclose cycle, if used Setting range: 0.05 s to 1800.00 s</p>
 <div style="border: 1px solid black; padding: 5px; display: inline-block;"> 3 4 A R T 4 0 . 1 0 s </div> 	<p>[3468] Dead time for the fourth and any further auto-reclose cycle, if used Setting range: 0.05 s to 1800.00 s</p>
 <div style="border: 1px solid black; padding: 5px; display: inline-block;"> 3 4 T - R E C 1 0 . 0 0 s </div> 	<p>[3469] Reclaim time after successful auto-reclosure Setting range: 0.05 s to 320.00 s</p>
 <div style="border: 1px solid black; padding: 5px; display: inline-block;"> 3 4 T - L O C 3 . 0 0 s </div> 	<p>[3470] Lock-out time after unsuccessful AR Setting range: 0.05 s to 320.00 s</p>
 <div style="border: 1px solid black; padding: 5px; display: inline-block;"> 3 4 T - B L M 1 . 0 0 s </div> 	<p>[3471] Blocking time after manual closing of circuit breaker Setting range: 0.50 s to 320.00 s</p>

6.3.11 Settings for circuit breaker control – address block 37



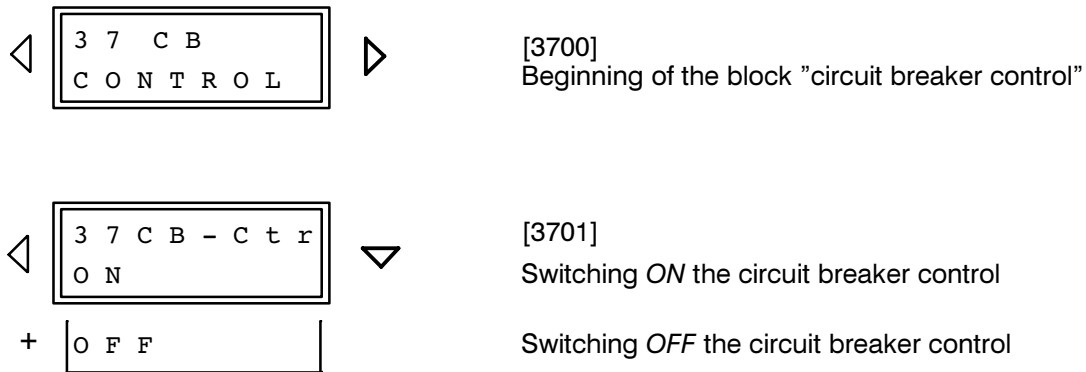







The circuit breaker control can be set *ON* or *OFF* in address 3701.



6.3.12 Settings for user definable logic functions – address block 38

Four user definable logical functions are available. Each function can be triggered by binary inputs and marshalled to binary outputs (LEDs, signal relays, trip relays). For pick-up, delay times can be set in address block 38.

Note that the set times are pure delay times which do not include the inherent operating times of the binary inputs and outputs.

 <div style="border: 1px solid black; padding: 5px; display: inline-block;"> 3 8 D E L A Y A N N U N C . </div> 	<p>[3800] Beginning of block "User definable logical functions"</p>
 <div style="border: 1px solid black; padding: 5px; display: inline-block;"> 3 8 T - A n c 1 0 . 0 1 s </div> 	<p>[3801] Pick-up time delay for the first user definable logical function Smallest setting value: 0.00 s Largest setting value: 10.00 s and ∞, i.e. no start</p>
 <div style="border: 1px solid black; padding: 5px; display: inline-block;"> 3 8 T - A n c 2 0 . 0 1 s </div> 	<p>[3802] Pick-up time delay for the second user definable logical function Smallest setting value: 0.00 s Largest setting value: 10.00 s and ∞, i.e. no start</p>
 <div style="border: 1px solid black; padding: 5px; display: inline-block;"> 3 8 T - A n c 3 0 . 0 1 s </div> 	<p>[3803] Pick-up time delay for the third user definable logical function Smallest setting value: 0.00 s Largest setting value: 10.00 s and ∞, i.e. no start</p>
 <div style="border: 1px solid black; padding: 5px; display: inline-block;"> 3 8 T - A n c 4 0 . 0 1 s </div> 	<p>[3804] Pick-up time delay for the fourth user definable logical function Smallest setting value: 0.00 s Largest setting value: 10.00 s and ∞, i.e. no start</p>

6.3.13 Settings for trip circuit supervision – address block 39

The relay includes a trip circuit supervision function (refer to Section 4.7), which requires one or two binary inputs. This can operate only when it is configured (refer to Section 5.4.2) using one ("*bypass-R*") or two ("*with 2 BI*") binary inputs. Furthermore, the adequate number of binary inputs must be allocated to this function and the external wiring must be correct.

If one binary input is used, trip circuit faults like interruption or control voltage failure can be detected but

not trip circuit fault which occur during closed trip relay of the device. But if the trip command lasts more than 60 s to 90 s, then the trip circuit supervision will give alarm even without any other fault.

Details about the function of this supervision are given in Section 4.7. Section 5.2.3 contains information about connection and dimensioning hints as to the resistor in case of supervision with one single binary input.



[3900]
Beginning of the block "Trip circuit supervision"



[3901]
Switch *ON* the trip circuit supervision

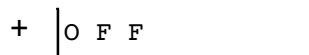

Switch *OFF* the trip circuit supervision

6.4 Annunciations

6.4.1 Introduction

After a network fault, annunciations and messages provide a survey of important fault data and the function of the relay, and serve for checking sequences of functional steps during testing and commissioning. Further, they provide information about the condition of measured data and the relay itself during normal operation.

To read out recorded annunciations, no codeword input is necessary.

The annunciations generated in the relay are presented in various ways:

- LED indications in the front plate of the relay (Figure 6.1),
- Binary outputs (output relays) via the connections of the relay,
- Indications in the display on the front plate or on the screen of a personal computer, via the operating interface,

Most of these annunciations can be freely allocated to the LEDs and binary outputs (see Section 5.5). Also, within specific limitations, group and multiple indications can be formed.

To call up annunciations on the operator panel scroll with the key ▽ to the item "ANNUNC." (annunciations), refer to Figure 6.3. The key ▷ changes over to the second operation level, where you can reach the different groups of annunciations with the scrolling keys ▽ and Δ.

When the relay is operated from a personal computer by means of the protection data processing pro-

gram DIGSI[®], the annunciation groups are identified by a four-digit address number. In the following clarifications, this number is indicated at the beginning of the explanations in brackets.

The annunciations are arranged as follows:

Block 81 Operational annunciations; these are messages which may appear during the operation of the relay: information about condition of relay functions, measurement data etc.

Block 82 Event annunciations for the last eight network faults: pick-up, trip, AR (if fitted and used), expired times, or similar. As defined, a network fault begins with pick-up of any fault detector and ends after drop-off of the last protection function. If auto-reclosure is carried out, the network fault ends after expiry of the last reclaim or lock-out time; thus an AR-shot (or all shots) occupy only one fault data store. Within a network fault, several fault events can occur, from pick-up of any fault detection until drop-off of the latest protection function.

Block 84 Indication of operational measured values (current magnitudes, values of the thermal overload protection).

The annunciations and measured values are arranged in lists. After paging to a certain annunciation block, an extract (two lines) of a list is shown in the display; the list can be scrolled by the keys ▽ and Δ, as illustrated in Figure 6.4.



[5000]
Commencement of "annunciation blocks"

A comprehensive list of the possible annunciations and output functions with the associated function number FNo is given in Appendix C. It is also indicated to which device each annunciation can be routed.

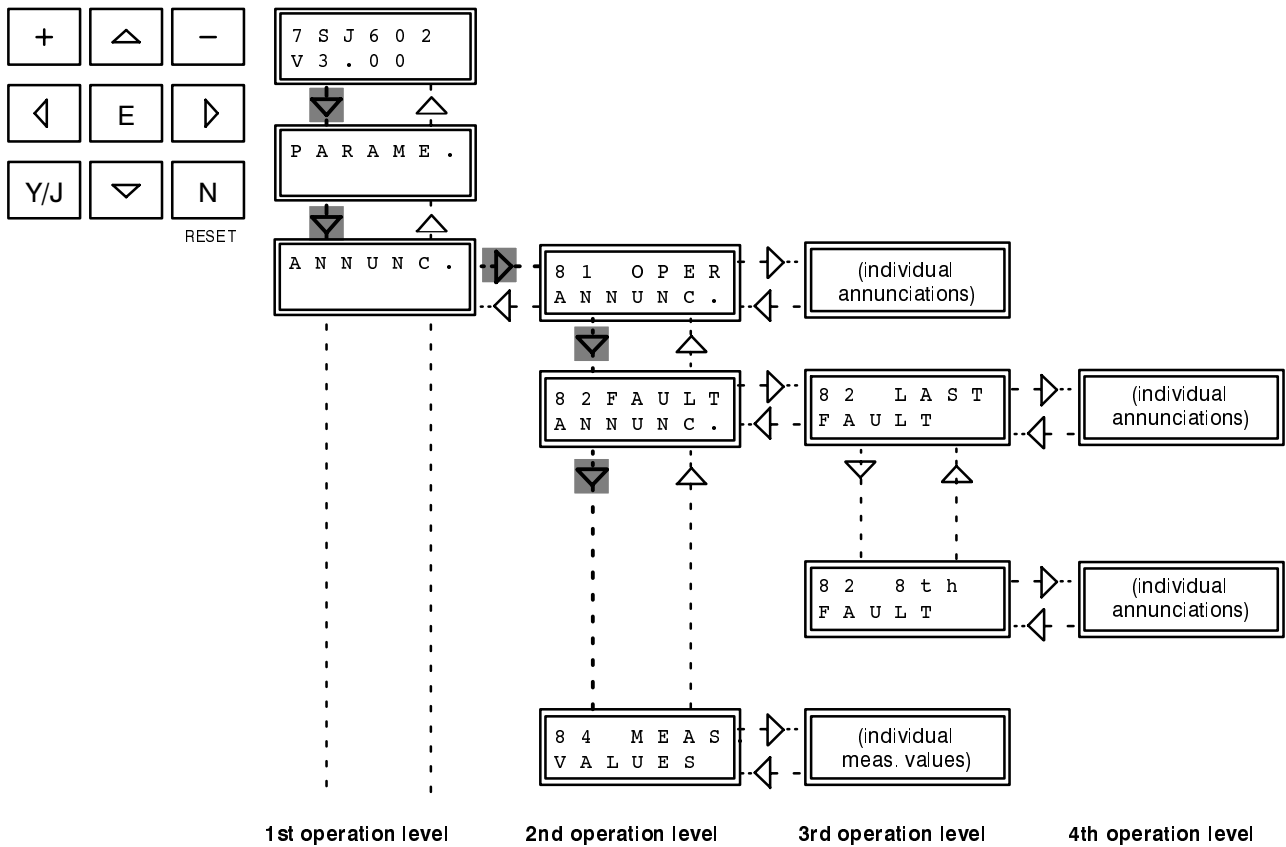

Figure 6.3 Selection of annunciation blocks

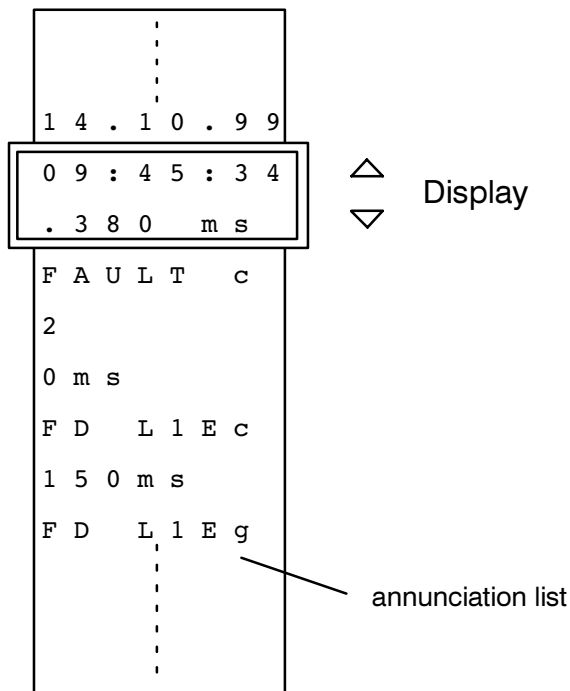

Figure 6.4 Display of an annunciation list – example

6.4.2 Operational annunciations – address block 81



Operational and status annunciations contain information which the unit provides during operation and about the operation. They begin at address block 81. Important events and status changes are chronologically listed, starting with the most recent message. Time information is shown in hours, minutes and seconds. Up to 30 operational indications can be stored. If more occur, the oldest are erased in sequence.



Faults in the network are only indicated as "FAULT" together with the sequence number of the fault. Detailed information about the history of the fault is contained in the block "Fault annunciations"; refer to Section 6.4.3.

The input of the codeword is not required. The boxes below show all available operational annunciations. In each specific case, of course, only the associated annunciations appear in the display.



Next to the boxes below, the abbreviated forms are explained. It is indicated whether an event is announced on occurrence (**c** = "coming") or a status is announced "coming" and "going" (**c/g**).

The first listed message is, as example, assigned with date and time in the first two lines; the third line shows the beginning of a condition with the character **c** to indicate that this condition occurred at the displayed time.

 <div style="border: 1px solid black; padding: 5px; display: inline-block;"> 8 1 O P E R . A N N U N C . </div> 	[5100] Beginning of the block "Operational annunciations"
---	--

 <div style="border: 1px solid black; padding: 5px; display: inline-block;"> 1 4 . 1 0 . 9 9 0 9 : 4 5 : 3 4 </div> 	1st line: Date of the event or status change 2nd line: Time of the event or status change
---	--

Use the arrow keys to scroll through the displayed annunciation list.

 <div style="border: 1px solid black; padding: 5px; display: inline-block;"> 0 9 : 4 5 : 3 4 L E D r e s c </div> 	1st line: Time of the event or status change 2nd line: Annunciation text, in the example coming
---	--

When date and time have not yet been set (refer also to Section 6.5.1), the date is shown as 01.01.95, the time is given as relative time from the last re-start of the processor system.

Direct response from binary inputs:

> m C L O S E	Manual close command (c/g)
> C B c l o	Circuit breaker closed (from CB auxiliary contact) (c/g)
> I > > b l k	Block I>> stage of phase overcurrent protection from an external device (c/g)
> I > b l k	Block I> stage of definite time phase overcurrent protection from an external device (c/g)
> I p b l k	Block I _p stage of inverse time phase overcurrent protection from an external device (c/g)
> I E > > b k	Block I _E >> stage of earth overcurrent protection from an external device (c/g)

> I E > b k	Block I _{E>} stage of definite time earth overcurrent protection from an external device (c/g)
> I E p b k	Block I _{Ep} stage of inverse time earth overcurrent protection from an external device (c/g)
> A R S t .	Start internal auto-reclosure (initiation) (c/g)
> A R b l S t	Block initiation of internal auto-reclosure (c/g)
> A R b l C l	Block reclose command of internal auto-reclosure (statically) (c/g)
> r e v P h R	Reversed phase rotation (c/g)
> I > > > b k	Block instantaneous very high set stage I>>> of the phase overcurrent protection via binary input (c/g)
> T r p R e l	Trip circuit supervision: binary input in parallel to trip contact (c/g)
> C B a u x	Trip circuit supervision: binary input in parallel to CB auxiliary contact (c/g)

General operational annunciations of the protection device:

o p e r a t .	At least one protection function operative (c/g)
L E D r e s	Stored LED indications reset (c)
R E C d e l	Fault recording data deleted (c)
S y s . F l t	Network system fault (c), detailed information in the fault annunciations
F A U L T	Fault with associated sequence number (c)
> m C L O S E	Manual close command (c/g)
> C B c l o	Circuit breaker is closed (c/g)

Annunciations of monitoring functions:

A N N l o s t	Annunciations lost (buffer overflow) (c)
P C a n n L T	Annunciations for operating (PC) interface lost (c)
F a i l Σ I	Failure: Current summation supervision (c/g)

Operational annunciations of time overcurrent protection:

<code>O / C p o f f</code>	Phase overcurrent protection is switched off (c/g)
<code>O / C p b l k</code>	Phase overcurrent protection is blocked (c/g)
<code>O / C p a c t</code>	Phase overcurrent protection is active (c/g)
<code>O / C e o f f</code>	Earth overcurrent protection is switched off (c/g)
<code>O / C e b l k</code>	Earth overcurrent protection is blocked (c/g)
<code>O / C e a c t</code>	Earth overcurrent protection is active (c/g)
<code>> I >> b l k</code>	Block I>> stage of phase overcurrent protection via binary input (c/g)
<code>> I > b l k</code>	Block I> stage of definite time phase overcurrent protection via binary input (c/g)
<code>> I p b l k</code>	Block I _p stage of inverse time phase overcurrent protection via binary input (c/g)
<code>> I E >> b k</code>	I _E >> stage of earth overcurrent protection blocked via binary input (c/g)
<code>> I E > b k</code>	I _E > stage of definite time earth overcurrent protection blocked via binary input (c/g)
<code>> I E p b k</code>	I _E p stage of inverse time earth overcurrent protection blocked via binary input (c/g)
<code>F D d y n</code>	O/C prot. : dynamic parameters active (c/g)

Operational annunciations of thermal overload protection:

<code>O / L o f f</code>	Overload protection is switched off (c/g)
<code>O / L b l k</code>	Overload protection is blocked (c/g)
<code>O / L a c t</code>	Overload protection is active (c/g)
<code>O / L w r n</code>	Overload protection with memory thermal warning stage (c/g)
<code>O / L p / u</code>	Overload protection without memory pick-up (c/g)

Operational annunciations of unbalanced load protection:

I 2 o f f	Unbalanced load protection is switched off (c/g)
I 2 b l k	Unbalanced load protection is blocked (c/g)
I 2 a c t	Unbalanced load protection is active (c/g)

Operational annunciations of start-up time supervision:

S R T o f f	Start-up time supervision is switched off (c/g)
S R T b l k	Start-up time supervision is blocked (c/g)
S R T a c t	Start-up time supervision is active (c/g)
S R T T r p	Start-up time supervision trip (c/g)

Operational annunciations of the internal auto-reclose function:

A R o f f	Auto-reclosure is switched off or blocked (c/g)
A R a c t .	Auto-reclosure is active (c/g)
A R b l M C	Auto-reclosure is blocked by manual close command (c/g)
A R D T	Auto-reclosure: dead time started with number of AR cycle (c)
> A R S t .	Internal auto-reclosure started via binary input (initiation) (c/g)
> A R b l S t	Initiation of internal auto-reclosure blocked via binary input (c/g)
> A R b l C l	Close command of internal auto-reclosure blocked via binary input (statically) (c/g)

Operational annunciations of trip circuit supervision:

S U P o f f

Trip circuit supervision is switched off (c/g)

S U P b l k

Trip circuit supervision is blocked (c/g)

S U P a c t

Trip circuit supervision is active (c/g)

S U P n o B I

Trip circuit supervision is blocked, because binary input is not marshalled (c/g)

C I R i n t

Trip circuit is interrupted (c/g)

Operational annunciations of the circuit breaker test function:

C B t e s t

Circuit breaker test in progress (c/g)

C B t p T S T

Trip by internal circuit breaker test function (c/g)

C B T w A R

Internal circuit breaker trip test with auto-reclosure (c/g)

6.4.3 Fault annunciations – address block 82

The annunciations which occurred during the last eight network faults can be read off on the front panel or via the operating interface. The indications are recorded in the sequence from the youngest to the oldest. When a ninth fault occurs, the data relating to the oldest are erased. Each of the eight fault data buffer can contain up to 30 annunciations. When more occur, the last message signals "buffer overflow".

Input of the codeword is not required.

When the relay is operative and the initial display or the quiescent messages are displayed, press the key ▽ to reach the item "ANNUNC." Key ▷ is used to change over to the second operation level, where one can go with the key ▽ to the address block 82 which forms the heading of the fault annunciations. The third operation level, with key ▷ contains the eight system faults. The individual annunciations can be found in the fourth operation level (key ▷), see Figure 6.3. Use the keys ▽ and △ to scroll

through the annunciation list (Figure 6.4).

For these purposes, the term "system fault" means the period from short-circuit inception up to final clearance. If auto-reclosure is carried out, the network fault ends after expiry of the last reclaim or lock-out time. Within a network fault, several fault events can occur, from pick-up of any fault detection until drop-off of the latest protection function.

When date and time have not yet been set (refer also to Section 6.5.1), the date is shown as 01.01.95, the time is given as relative time from the last re-start of the processor system. Thereafter, the fault annunciations are listed in chronological sequence with the relative time referred to the first fault detection.

In the following clarification, all the available fault annunciations are indicated. In the case of a specific fault, of course, only the associated annunciations appear in the display. At first, an example is given for a system fault, and explained.

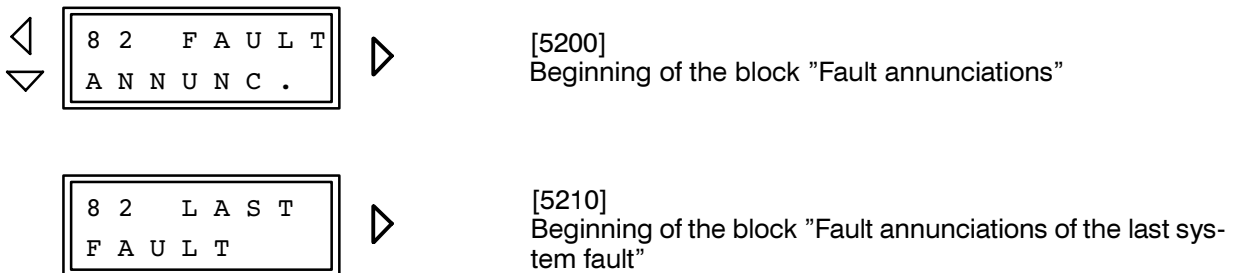

Use the arrow keys to scroll through the displayed annunciation list.

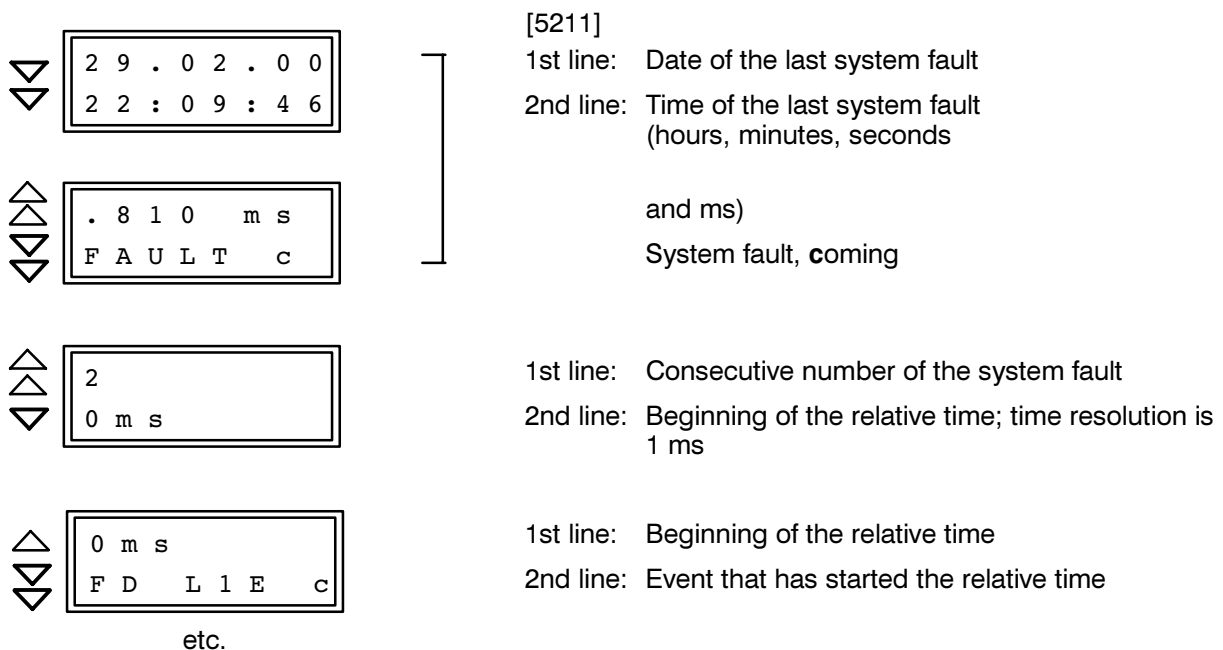

General fault annunciations of the device:

S y s . F l t	Network system fault
F A U L T	Beginning of fault
A N N o v f l	Fault annunciations lost (buffer overflow)
F T d e t	General fault detection of device
D E V . T r p	General trip of device
I L 1	Interrupted fault current of phase L1 (I_{L1}/I_N)
I L 2	Interrupted fault current of phase L2 (I_{L2}/I_N)
I L 3	Interrupted fault current of phase L3 (I_{L3}/I_N)

Fault annunciations of time overcurrent protection:

F D L 1	Fault detection overcurrent protection, phase L1
F D L 1 E	Fault detection overcurrent protection, phase L1 – E
F D L 2	Fault detection overcurrent protection, phase L2
F D L 2 E	Fault detection overcurrent protection, phase L1 – E
F D L 1 2	Fault detection overcurrent protection, phases L1 – L2
F D L 1 2 E	Fault detection overcurrent protection, phases L1 – L2 – E
F D L 3	Fault detection overcurrent protection, phase L3
F D L 3 E	Fault detection overcurrent protection, phase L1 – E
F D L 1 3	Fault detection overcurrent protection, phases L1 – L3
F D L 1 3 E	Fault detection overcurrent protection, phases L1 – L3 – E
F D L 2 3	Fault detection overcurrent protection, phases L2 – L3
F D L 2 3 E	Fault detection overcurrent protection, phases L2 – L3 – E
F D L 1 2 3	Fault detection overcurrent protection, phases L1 – L2 – L3
F D L 1 2 3 E	Fault detection overcurrent protection, phases L1 – L2 – L3 – E
F D E	Fault detection overcurrent protection, earth fault

F D I > >	Fault detection of the I>> phase current stage
T r p I > > >	Trip by overcurrent protection, stage I>>> (phases)
F D I >	Fault detection of the I> phase current stage (definite time)
T r i p I >	Trip by overcurrent protection, stage I> (phases)
T r p I > >	Trip by overcurrent protection, stage I>> (phases)
F D I p	Fault detection of the I _p phase current stage (inverse time)
T r i p I p	Trip by overcurrent protection, stage I _p (phases, inverse time)
F D I E > >	Fault detection of the I _E >> earth current stage
T r p I E > >	Trip by overcurrent protection, stage I _E >> (earth)
F D I E >	Fault detection of the I _E > earth current stage (definite time)
T r p I E >	Trip by overcurrent protection, stage I _E > (earth)
F D I E p	Fault detection of the I _{Ep} earth current stage (inverse time)
T r p I E p	Trip by overcurrent protection, stage I _{Ep} (earth, inverse time)

Fault annunciations of unbalanced load protection:

F D I 2 > >	Fault detection unbalanced load protection, stage I ₂ >>
F D I 2 >	Fault detection unbalanced load protection, stage I ₂ >
T r p I 2	Trip by unbalanced load protection

Fault annunciations of thermal overload protection:

O / L w r n	Overload protection with memory: Thermal warning stage
O / L p / u	Overload protection without memory: Pick-up
O / L T r p	Trip by overload protection

Fault annunciation of start-up time monitor:

S R T T r p	Trip by start-up time monitor
-------------	-------------------------------

Fault annunciations of the internal auto-reclosure function:

> A R S t .	Internal auto-reclosure started via binary input (initiation)
> A R b l S t	Initiation of internal auto-reclosure blocked via binary input
> A R b l C l	Close command of internal auto-reclosure blocked via binary input (statically)
A R i p g	Auto-reclosure in progress
A R C l C m	Auto-reclosure: close command
A R d T r p	Auto-reclosure: definitive (final) trip
A R S t r t	Internal auto-reclosure started (general)
A R b l C l	Close command of internal auto-reclosure blocked (general)
A R b l S t	AR: start blocked (general)
A R D T	Auto-reclosure: dead time started with number of AR cycle

Further messages:

T A B e m p t y	means that no fault event has been recorded
T A B o v r f l	means that other fault data have occurred, however, memory is full
T A B . E N D	If not all memory places are used the last message is TAB.END

Use key ∇ to go back to the third operation level. You can reach the **second to last** system fault by pressing the key ∇ . The individual fault annunciations can be found with the key \triangleright in the fourth operation level and scrolled through with the keys ∇ and \triangle . The available annunciations are the same as for the last fault.

∇	<div style="border: 1px solid black; padding: 5px; display: inline-block;"> 8 2 2 n d F A U L T </div>	\triangleright	[5220] Beginning of the "Fault annunciations of the second to last system fault"
----------	---	------------------	---

In corresponding way the annunciations of the third to last up to the eighth to last fault can be achieved.

6.4.4 Read-out of operational measured values – address block 84

Operating measured values can be read out at any time under the address block 84. When the relay is operative and the initial display or the quiescent messages are displayed, press the key ▽ to reach the item "ANNUNC." Key ▷ is used to change over to the second operation level, where one can go with the key ▽ to the address block 84 which forms the heading of the operational measured values. The individual annunciations can be found in the third operation level (key ▷), see Figure 6.3. Use the keys ▽ and Δ to scroll through the individual measured values (Figure 6.4).

Entry of the codeword is not necessary.

The data are displayed in percent of the rated device values. During read-out, the values are not actualized, but after scrolling through the list with the keys ▽ and Δ, the actual values will be displayed.

In the following example, some example values have been inserted. In practice the actual values appear.



[5200]
Beginning of the block "Operational measured values"

Use ▽ key to move to the next address with the next measured value.

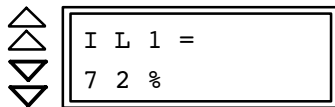



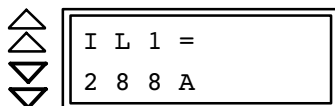
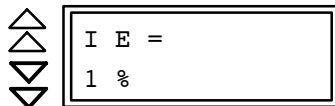
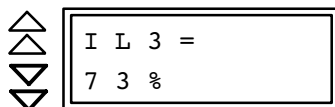
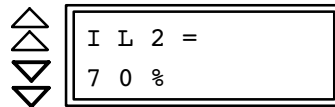

Page on with the ▽ key to read off the next measured value, or page back with Δ

The percentage is referred to rated relay current

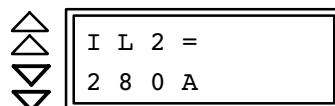



The primary values are calculated on the base of the set primary rated current (address 1105, see Section 6.3.3)





I L 3 = 2 9 1 A

I E = 5 A

T H E T A = 4 3 %

The calculated temperature rise for the overload protection with memory can be read out in percent of the trip temperature rise.





t T r p = I N V A L

When the warning temperature rise is exceeded (overload protection with total memory) or the pick-up value is exceeded (overload protection without memory) the calculated trip time (with constant current) is indicated, either in seconds or in minutes, in two messages. The inapplicable message is marked with "INVALID". "INVALID" is indicated also when no trip is expected





t r e l = I N V A L

When the overload protection with total memory is effective and the protection has tripped, the time is indicated until the temperature rise will have decreased below the warning temperature rise, i.e. the time until reset of the overload protection, is indicated, either in seconds or in minutes, in two messages. The inapplicable message is marked with "INVALID"

6.5 Operational control facilities

During operation of the protection relay it may be desired to intervene in functions or annunciations manually or from system criteria. 7SJ602 comprises facilities, e.g. to re-adjust the real time clock and to switch on or off partial functions under specific conditions, or to change over preselected pick-up values (dynamic change-over of pick-up values of the time overcurrent protection).

The functions can be controlled from the operating panel on the front of the device, via the operating interface as well as via binary inputs. Refer to the Sections 6.3.4 to 6.3.10 for the appropriate setting addresses and Section 5.5.2 for the allocation of binary inputs.

In order to control functions via binary inputs it is necessary that the binary inputs have been marshalled to the corresponding switching functions during installation of the device and that they have

been connected (refer Section 5.5.2 Marshalling of the binary inputs).

Operational control via the key pad or the operation interface is carried out under the item "ADDITION FUNCTION" (additional functions). When the relay is operative and the initial display or the quiescent messages are displayed, press the key ▽ to reach the item "ADDITION FUNCTION". Key ▷ is used to change over to the second operation level, where one can go with the key ▽ to the required control addresses.

When the relay is operated from a personal computer by means of the protection data processing program DIGSI[®], the control items are identified by a four-digit address number. In the following clarifications, this number is indicated at the beginning of the explanations in brackets.

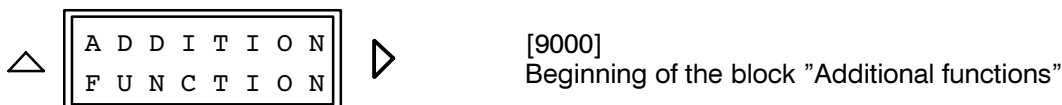

6.5.1 Adjusting and synchronizing the real time clock

Key ▷ is pressed to change to the second operation level. The display shows the first item "TIME SETTING". Change to the third operation level with key ▷. The actual date and time are displayed now. Scroll on with key ▽ to find the setting items for date and time, as illustrated below.

When date and time have not yet been set, the date "01.01.95" appears and the time since the start-up of the processor system.

The next two addresses allow to set date and time.

Codeword entry is not required. Day, month, and year can be altered using the keys ⊕ and ⊖. Key ▷ is used to switch from day to month etc. Confirm with the enter key **E** when the date is completed. Proceed in analog manner to adjust the time.

Note: When the day is changed, the display firstly allows 31 days. Only when the month and year is changed, the relay can check plausibility of the complete date. After confirmation with the enter key **E**, the day may be reduced to an existing number.

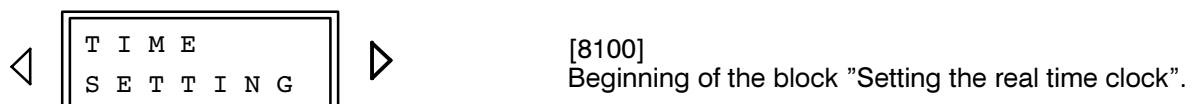

◀

0	1	.	0	1	.	9	9
0	1	:	1	5	:	0	6









 ▼

[8101]
At first, the "actual" date (**DD.MM.YY**) and the "actual" time (**HH:MM:SS**) are displayed.
Continue with ▼.

◀

D	A	T	E				
2	9	.	0	2	.	0	0





[8102]
Enter the new date: 2 digits for day, 2 digits for month and 2 digits for year: **DD** ▶ **MM** ▶ **YY**

Use key  to increase the day or  to decrease;
use key  to change-over to the month;
use key  to increase the month or  to decrease;
use key  to change-over to the year;
use key  to increase the year or  to decrease;
confirm with enter key **E**.

◀

T	I	M	E				
1	3	:	4	4	:	2	7

[8103]
Key ▼ is used to come to the time setting. Enter the new time:
2 digits for hour, 2 digits for minute: **HH** ▶ **MM**

Use key  to increase the hour or  to decrease;
use key  to change-over to the minute;
use key  to increase the minute or  to decrease;

the seconds are not changed. They are automatically set to "00" when the enter key **E** is pressed.

6.5.2 Circuit breaker control

From the item "ADDITION FUNCTION" of the first operation level, as above, you switch to the second operation level with the key \triangleright and select with ∇ the option "BREAKER CONTROL". Breaker control is only possible if this function had been switched ON during setting of the functional parameters (refer to Section 6.3.11).

\triangleleft

B R E A K E R C O N T R O L

 \triangleright [7500]
Block "Circuit breaker control"

Change with the \triangleright key to the block with the individual control commands. Select the desired control operation (open or close) with ∇ .

\triangleleft

C B O P E N ?

E [7501]
After confirmation with the enter key **E** the relay requests for codeword input. After correct codeword input, repeat confirmation with the enter key **E**. The relay checks whether breaker operation is permitted. The command is rejected when another command is already being executed or when an auto-reclose cycle is in progress.

\triangleleft

C B S T A R T E D

E The device confirms the command. With the \triangleleft key, the higher operation level can be reached.

\triangleleft

C B C L O S E ?

E [7502]
After confirmation with the enter key **E** the relay requests for codeword input. After correct codeword input, repeat confirmation with the enter key **E**. When an auto-reclose cycle is in progress, this is aborted.

\triangleleft

C B S T A R T E D

E The device confirms the command. With the \triangleleft key, the higher operation level can be reached.

6.6 Testing and commissioning

6.6.1 General

Prerequisite for commissioning is the completion of the preparation procedures detailed in Chapter 5.



Warning

Hazardous voltages are present in this electrical equipment during operation. Non-observance of the safety rules can result in severe personal injury or property damage.

Only qualified personnel shall work on and around this equipment after becoming thoroughly familiar with all warnings and safety notices of this manual as well as with the applicable safety regulations.

Particular attention must be drawn to the following:

- ▶ The earthing screw of the device must be connected solidly to the protective earth conductor before any other connection is made.
- ▶ Hazardous voltages can be present on all circuits and components connected to the supply voltage or to the measuring and test quantities.
- ▶ Hazardous voltages can be present in the device even after disconnection of the supply voltage (storage capacitors!).
- ▶ The limit values given in the Technical data (Section 3.1) must not be exceeded at all, not even during testing and commissioning.

When testing the unit with a secondary injection test set, it must be ensured that no other measured values are connected and that the tripping leads to the circuit breaker trip-coils have been interrupted.



DANGER!

Secondary connections of the current transformers must be short-circuited before the current leads to the relay are interrupted!

If a test switch is installed which automatically short-circuits the current transformer secondary leads, it is sufficient to set this switch to the "Test" position. The short-circuit switch must be checked beforehand (refer Section 5.2.4).

It is recommended that the actual settings for the relay be used for the testing procedure. If these values are not (yet) available, test the relay with the factory settings. In the following description of the test sequence the preset settings are assumed.

For the functional test a three-phase symmetrical current source with individually adjustable currents should be available. For checking the pick-up values a single-phase current source is sufficient.

NOTE! The accuracy which can be achieved during testing depends on the accuracy of the testing equipment. The accuracy values specified in the Technical data can only be reproduced under the reference conditions set down in IEC 60255 resp. VDE 0435/part 303 and with the use of precision measuring instruments. The tests are therefore to be looked upon purely as functional tests.

During all the tests it is important to ensure that the correct command (trip) contacts close, that the proper indications appear at the LEDs and the output relays for remote signalling.

After tests which cause LED indications to appear, these should be reset, at least once by each of the possible methods: the reset button **N** on the front plate and via the remote reset relay (if marshalled, see connection diagrams, Appendix A). If the reset functions have been tested, resetting the stored indications is no more necessary as they are erased automatically with each new pick-up of the relay and replaced by the new annunciations.

6.6.2 Testing the high-set overcurrent protection stages $I_{>>}$, $I_E>>$, and the instantaneous stage $I_{>>>}$

In order to test the high-set overcurrent protection stages, the related functions must be switched on (address block 10 O/C ph = ON and/or address block 11 O/C e = ON (as delivered)).

Testing can be performed with single-phase, two-phase or three-phase test current for the phase current stages; for the earth current stage, the test current must pass through the earth current input I_E .



Caution!

Test currents larger than 4 times I_N may overload and damage the relay if applied continuously (refer to Section 3.1.1 for overload capability). Observe a cooling down period!

For testing the $I_{>>}$ stages and the $I_{>>>}$ stage, therefore, measurement shall be performed dynamically. It should be stated that the relay picks up at 1.1 times setting value and does not pick up at 0.9 times setting value.

When the test current is injected via one phase and the earth path and the set value for $I_E>>$ (address block 11, factory setting $0.5 \times I_N$) is exceeded the pick-up annunciation "FD $I_E>>$ " appears, with further increase above the pick-up value of the high-set phase current stage (address block 10, factory setting $2 \times I_N$) pick-up annunciation "FD $I_{>>}$ " and the pick-up indication appears for the tested phase ("O/C AL*" and LED 1 for L1 or LED 2 for L2 or LED 3 for L3 at factory setting). Check that the assigned signal relay 2 (at factory setting) contacts close.

After expiry of the time delay (TIE>> for the earth current path, factory setting 0.1 s; TI>> for the phase path, factory setting 0.03 s), trip signal is given (LED 4 at delivery). Check that the assigned trip relay (1) contacts close.

The very high instantaneous stage $I_{>>>}$ is preset to ∞ . It can only be tested when a definite value has been set. The test current should be at least twice the setting value to ensure that this stage operates fast; but still observe thermal capability! Annunciation "TRPI>>>" appears.

If the change-over facility of dynamic pick-up values is used, this should be checked, too, in order to en-

sure that the associated binary input operates correctly. The dynamic very high instantaneous stage $I_{>>>dyn}$ is preset to ∞ . It can only be tested when a definite value has been set. The binary input assigned to the dynamic switch over is energized (not allocated when delivered). Test must be performed within the set duration for these stages T_{dyn} (600 s when delivered).

It must be noted that the set times are pure delay times; operating times of the measurement functions are not included.

6.6.3 Testing the definite time overcurrent protection stages $I_{>}$, $I_E>$

For these tests the related functions must be switched on, furthermore, a mode must have been selected in addresses block 00 (O/Cch) which includes the definite time protection, i.e. *def TIME* (as delivered), *IEC O/C*, or *ANSI O/C*.

Testing can be performed with single-phase, two-phase or three-phase test current for the phase current stages; for the earth current stage, the test current must pass through the earth current input I_E .

For test current below $4 \times I_N$, slowly increase the test current over one phase and earth until the protection picks up.



Caution!

Test currents larger than 4 times I_N may overload and damage the relay if applied continuously (refer to Section 3.1.1 for overload capability). Observe a cooling down period!

For test currents above $4 \times I_N$ measurement shall be performed dynamically. It should be stated that the relay picks up at 1.1 times setting value and does not pick up at 0.9 times setting value.

When the test current is injected via one phase and the earth path and the set value for $I_E>$ (address block 11: $I_E>$, factory setting $0.2 \times I_N$) is exceeded the pick-up annunciation "FD $I_E>$ " appears, with further increase above the pick-up value of the phase current stage (address block 10: $I_{>}$, factory setting $1 \times I_N$) pick-up indication appears for the tested phase (LED 1 for L1 or LED 2 for L2 or LED 3 for L3 at factory setting).

After expiry of the time delay (TIE > for the earth current path, factory setting 0.5 s; TI > for the phase path, factory setting 0.5 s), trip signal is given (LED 4 at delivery). Check that the assigned signal relay and trip relay contacts close.

If the change-over facility of dynamic pick-up values is used, this should be checked, too, in order to ensure that the associated binary input operates correctly. The binary input assigned to the dynamic switch over is energized (not allocated when delivered). Test must be performed within the set duration for these stages T_{dyn} (600 s when delivered).

It must be noted that the set times are pure delay times; operating times of the measurement functions are not included.

6.6.4 Testing the inverse time over-current protection stages I_p, I_{Ep}

For these tests the related functions must be switched on, furthermore, a mode must have been selected in addresses block 00 (O/Cch) which includes an inverse time protection, i.e. *IEC inv.*, *ANSI inv.*, *IEC O/C* or *ANSI O/C*. In address block 10, the valid characteristic must have been set.

Testing can be performed with single-phase, two-phase or three-phase test current for the phase current stages; for the earth current stage, the test current must pass through the earth current input I_E.

For test current below 4 x I_N, slowly increase the test current over one phase and earth until the protection picks up.



Caution!

Test currents larger than 4 times I_N may overload and damage the relay if applied continuously (refer to Section 3.1.1 for overload capability). Observe a cooling down period!

For test currents above 4 x I_N measurement shall be performed dynamically. It should be stated that the relay picks up at 1.2 times setting value and does not pick up at 1 times setting value.

When the test current is injected via one phase and the earth path and the set value for I_{Ep} (factory setting 0.1 x I_N) is exceeded by more than 1.1 times the set value (for IEC-characteristics) or 1.06 times the set value (for ANSI/IEEE-characteristic), pick-up indication for I_{Ep} appears: "FD I_{Ep}", with further increase above 1.1 times the pick-up value (for IEC-characteristics) or 1.06 times the set value (for ANSI/IEEE-characteristic) of the phase current stage (factory setting 1 x I_N) pick-up indication appears for the tested phase (LED 1 for L1 or LED 2 for L2 or LED 3 for L3 at factory setting). Check that the assigned signal relay contacts close.

With current less than 1.05 times setting value (for IEC-characteristics) or 1.03 times the set value (for ANSI/IEEE-characteristic), no pick-up must occur.

The time delay depends on which characteristic and which set time multiplier has been set. The expected time delays can be calculated from the formula given in the Technical data (Section 3.3) or read from the characteristic curves in Figures 3.1 to 3.4 (Section 3.3).

It is suggested that one point of the trip time characteristic is checked with 2 x setting value provided the thermal capability is not exceeded. Check that the assigned signal relay and trip relay contacts close.

If the change-over facility of dynamic pick-up values is used, this should be checked, too, in order to ensure that the associated binary input operates correctly. The binary input assigned to the dynamic switch over is energized (not allocated when delivered). Test must be performed within the set duration for these stages T_{dyn} (600 s when delivered).

6.6.5 Testing the unbalanced load protection

The unbalanced load protection can only be tested if this function has been configured in address block 00 as UNB.L = *EXIST* and parameterized as operative (UNB.L = *ON*).

The unbalanced load protection has two definite time delay stages (I2>, TI2> and I2>>, TI2>>).

Testing can be performed with single-phase, two-phase or three-phase test current. In the following, testing with a single-phase current is described. In this case the unbalanced load amounts to one third of the test current which is referred to the unit current.

When the pick-up value is exceeded (test current > 3 times setting values), the associated annunciations "FD I2>" and "FD I2>>" (signal relay 2 at delivery) must be indicated. After the associated time delay has expired (TI2> 5 s at delivery, TI2>> 1 s at delivery), trip annunciation "TRP I2" is issued (LED 4 at delivery). Check that the trip contacts close.

It must be noted that the set times are pure delay times; operating times of the measurement functions are not included.

6.6.6 Testing the overload protection

The overload protection can only be tested if it has been configured in address block 00 with total memory as *preLOAD* or without memory as *no preLD* and parameterized as operative under address block 27: O/L = *ON*.

Testing can be performed with single-phase, two-phase or three-phase test current.

6.6.6.1 Overload protection without memory

The overload protection without memory picks up when 1.1 times the set value IL is exceeded.

For test current below $4 \times I_N$, slowly increase the test current over one phase and earth until the protection picks up.



Caution!

Test currents larger than 4 times I_N may overload and damage the relay if applied continuously (refer to Section 3.1.1 for overload capability). Observe a cooling down period!

For test currents above $4 \times I_N$ measurement shall be performed dynamically. It should be stated that the relay picks up at 1.2 times setting value and does not pick up at 1 times setting value.

When the test current is injected via one phase and the set value for IL (factory setting $1 \times I_N$) is exceeded by more than 1.1 times the set value, pick-up indication for overload appears: "O/L p/u". Check that the assigned signal relay contacts close (signal relay 2 at factory setting).

The time delay depends on which time multiplier has been set. The expected time delays can be calculated from the formula given in the Technical data (Section 3.5.2) or read from the characteristic curves in Figures 3.7 (Section 3.5.2).

It is suggested that one point of the trip time characteristic is checked with 2 x setting value provided the thermal capability is not exceeded. Trip signal "O/L Trp" is given.

6.6.6.2 Overload protection with total memory

The basis current for the detection of overload is always the rated current of the device.

When applying the rated current (factory settings) tripping must not occur. After an appropriate time (approximately $5 \times \tau$) a steady-state temperature rise according to the following relationship is established:

$$\frac{\Theta}{\Theta_{\text{trip}}} = \frac{1}{k^2}$$

This value can be read out in address block 84. For different setting values k , test current should be lower than $k \times I_N$ (e.g. 90%).

To check the time constant, the current input is simply subjected to $1.6 \times$ the pick-up value, i. e. $1.6 \times k \times I_N$. Tripping will then be initiated after a time interval which corresponds to half the time constant.

It is also possible to check the trip characteristic (Figure 3.5). It must be noted, that before each measurement, the temperature rise must be reduced to zero. This can be achieved by either de-activating and re-activating the overload function (address block 27) or by observing a current free period of at least $5 \times k \times \tau$ or by blocking the overload protection via an correspondingly assigned binary input (>O/Lb1k).



Caution!

Test currents larger than 4 times I_N may overload and damage the relay if applied continuously (refer to Section 3.1.1 for overload capability). Observe a cooling down period!

If testing with preload is performed, then it must be ensured that a condition of thermal equilibrium has been established before time measurement commences. This is the case, when the preload has been applied constantly for a period of at least $5 \times \tau$.

6.6.7 Testing the start-up time monitor

The start-up time monitor can only be tested if it has been configured in address block 00 as $STRT = EX-IST$ and parameterized as operative ($STRT = ON$).

Testing can be performed with single-phase, two-phase or three-phase test current. Tests should be carried out dynamically, because of the high start-up currents.



Caution!

Test currents larger than 4 times I_N may overload and damage the relay if applied continuously (refer to Section 3.1.1 for overload capability). Observe a cooling down period!

For test currents above $4 \times I_N$ measurement shall be performed dynamically. It should be stated that the relay picks up at 1.1 times setting value and does not pick up at 0.9 times setting value.

The tripping time depends on the set start-up time, the set start-up current, and the test current. It can be calculated from the formula given in the Technical data (Section 3.6).

It is suggested that one point of the trip time characteristic is checked. For example, the preset values ($I_{strt} = 4 \times I_N$, $T_{strt} = 10$ s) result in a tripping time of 2.5 s when the test current amounts to 8 times I_N . Trip is annunciated with "SRT Trp".

Note: The start-up monitor operates independent on the thermal overload protection. Thus, it is possible that the overload protection may trip before the start-up time monitor does, dependent on the set parameters. If necessary, the overload protection may be switched off before testing the start-up time monitor. But do not forget to switch in on again after the tests, when it is to be used.

6.6.8 Testing the auto-reclose functions (if fitted)

The internal AR function can be tested provided it is fitted in the relay, configured in address block 00 as AR = *EXIST* (refer to Section 5.4.2) and switched to AR = *ON* (address block 34).

The binary input "circuit breaker ready" must be simulated should it be assigned to the corresponding input function (FNo 2734 ">ARb1Cl", i.e. block closing command, refer also to Section 5.5.2).

Depending of the selected AR program, a short circuit should be simulated for each of the desired auto-reclose shots, each time once with successful and once with unsuccessful AR. Check the proper

reaction of the relay according to the set AR programs.

Note that each new test can begin only after the previous test has completely terminated; otherwise an auto-reclosure cannot result: annunciation "AR i pg" (auto-reclosure in progress, FNo 2801, not allocated at delivery) must not be present or must be annunciated "Going".

If the circuit breaker is not ready and this is indicated to the relay as described above, a reclose attempt must not result.

6.6.9 Testing the trip circuit supervision

The trip circuit supervision function can only be tested if it has been configured in address block 00 (contrary to the state of delivery) *with 2 BI* (with 2 binary inputs) or *bypass-R* (with one binary input, the second is by-passed by a resistor). Furthermore, it must be switched *ON* in address block 39 (CIRsup = *ON*), and the associated binary input(s) must be marshalled for this purpose (refer to Section 5.5.2).

6.6.9.1 Trip circuit supervision with two binary inputs

In accordance with the task of this operation mode of the trip circuit supervision, the trip circuit is assumed to be disturbed when none of the two binary inputs is energized. (refer also to Section 4.7.1). This condition cannot occur steadily, i.e. over a certain time, as long as the trip circuit is operating correctly. It can only occur for a short time during the operation of the circuit breaker. Therefore, alarm is given, if this condition lasts for a time which corresponds to three measurement repetitions.

Energize the binary inputs one after the other: the fault indication disappears as long as one binary input is energized and reappears a short time after both inputs are de-energized.

When both control voltages are switched off, the annunciation "CIR int" (i.e. trip circuit interrupted, not allocated at delivery) appears after 400 ms to 700 ms.

6.6.9.2 Trip circuit supervision with one binary input

In accordance with the task of this operation mode of the trip circuit supervision, the trip circuit is assumed to be disturbed when the binary input is not energized. (refer also to Section 4.7.2). This condition cannot occur steadily, i.e. over a certain time, as long as the trip circuit is operating correctly. It can only occur for a short time during which the trip relay of the protection device is closed. Therefore, alarm is given, if this condition lasts for a time which should be longer than the duration of a trip command of the device.

Energize the binary input: the fault indication disappears.

When the control voltage is switched off, the annunciation "CIR int" (not allocated at delivery) appears after 60 s to 90 s.

6.7 Commissioning using primary tests

All secondary testing sets and equipment must be removed. Reconnect current transformers. For testing with primary values the protected object must be energized.



Warning

Primary tests shall be performed only by qualified personnel which is trained in commissioning of protection systems and familiar with the operation of the protected object as well as the rules and regulations (switching, earthing, etc.)

6.7.1 Current circuit checks

Connections to current transformers are checked with primary values. For this purpose a load current of at least 10 % of the rated current is necessary.

Currents can be read off on the display in the front or via the operating interface in block 84 and compared with the actual measured values (refer also to Section 6.4.4). If substantial deviations occur, then the current transformer connections are incorrect.



DANGER!

Secondary connections of the current transformers must be short-circuited before any current leads to the relay are interrupted!

No further tests are required for time overcurrent protection; these functions have been tested under 6.6.2 to 6.6.4. For checking the trip circuits at least one circuit breaker live trip should be performed (refer to Section 6.7.4).

6.7.2 Checking the reverse interlock scheme (if used)

For use and tests of the reverse interlock scheme it is necessary that at least one of the binary inputs has been assigned to the function ">I>> bk" and/or further blocking inputs. When delivered from factory, binary input BI 2 has been assigned to this function.

Reverse interlocking can be used in "normally open mode", i.e. the I>> stage is blocked when the binary input ">I>> bk" is energized, or "normally closed" mode, i.e. the I>> stage is blocked when the binary input ">I>> bk" is de-energized. The following procedure is valid for "normally open mode" as preset by the factory.

The protection relay on the incoming feeder and those on all outgoing circuits must be in operation. At first the auxiliary voltage for reverse interlocking should not be switched on.

Apply a test current which makes pick-up the I>> stage as well as the I> or I_p stage. Because of the absence of the blocking signal the relay trips after the (short) delay time TI>>.



Caution!

Test currents larger than 4 times I_N may overload and damage the relay if applied continuously (refer to Section 3.1.1 for overload capability). Observe a cooling down period!

Now switch on the d.c. voltage for the reverse interlocking. The test as described above is repeated, with the same result.

Simulate a pick-up on each protective device on all outgoing feeders. Simultaneously, a short circuit is simulated on the incoming feeder (as described before). Tripping now occurs after the delayed time TI> (0.5 s) or according to TIp (0.5 s).

If applicable repeat test for the earth current stages.

These tests have simultaneously proved that the wiring between the protection relays is correct.

6.7.3 Testing the user definable logic functions

The operation of the user definable logic functions is widely dependent of the application. The input condition have to be produced in accordance with the intended function, and the output conditions must be checked.

When measuring the delay times, it must be noted that the set time (pick-up and/or drop-off) delays do not include the inherent time of the input and output modules; these are additional.

6.7.4 Testing the switching conditions of binary inputs and outputs

The relay contains a test routine which interrogates the positions of the binary inputs and outputs and indicates them on the display.

Tests can be performed in address block 40. This block is reached by pressing the key ∇ three times so that the block "ADDITION FUNCTION" (additional functions) is displayed. Change to the second operation level by the key \triangleright ; "DATE/TIME" is displayed.

Key ∇ is pressed to scroll to the test blocks.

When the relay is operated from a personal computer by means of the protection data processing program DIGSI[®], the test items are identified by a four-digit address number. In the following clarifications, this number is indicated at the beginning of the explanations in brackets.



[4000]
Beginning of the block "Tests and commissioning aids"

Change over with key \triangleright to the next operation level which shows the heading of the input/output conditions. Page to the next operation level by the key \triangleright to gain access to the individual tests.

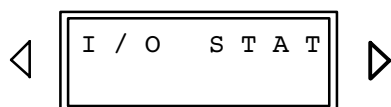

[4100]
Beginning of the block "Input/output status"



[4101]
Block "Status of the binary inputs"

Pressing the enter key **E** causes the relay to display the the question whether the states of the binary inputs shall be checked. Press the "Yes" – key **Y/J** to confirm, or the "No" – key **N** to abort. With the key ∇ the next test item can be selected.

Y e s / N o ? **Y/J**

Pressing the "Yes"-key **Y/J** makes the relay display the states of the binary inputs (BI). Each energized input is marked by its number, inputs which are not energized are marked with a -:

B I S T A T
1 2 - **▽**

- 1: BI 1 is energized (control voltage present)
- 2: BI 2 is energized (control voltage present)
- 3: BI 3 is energized (control voltage present)
- : BI is **not** energized (control voltage absent)

Indication for BI1, BI2, BI3

The illustrated example shows that the binary inputs BI 1 and BI 2 are energized, and binary input BI 3 is not energized.

Press the key **▽** to change to the conditions of the signal relays and trip relays:

△ R E - S T A T **E**

[4102]
Block "Status of the output relays"

Y e s / N o ? **Y/J**

Pressing the enter key **E** causes the relay to display the the question whether the states of the binary outputs (relays) shall be checked. Press the "Yes"-key **Y/J** to confirm, or the "No"-key **N** to abort.

R E - S T A T
S 1 - T - 2 **▽**

Pressing the "Yes"-key **Y/J** makes the relay display the states of the output relays (RE). The letter "S" indicates "Signal relay", "T" indicates "Trip relay". Each energized output is marked by its number, outputs which are not energized are marked with a -:

Indication for
signal relay 1 and 2

Indication for
trip relay 1 and 2

- 1: signal (S) or trip (T) relay 1 is energized
- 2: signal (S) or trip (T) relay 2 is energized
- : signal (S) or trip (T) relay is not energized

The illustrated example shows that the signal relay 1 is energized, signal relay 2 is not energized, trip relay 1 is not energized, trip relay 2 is energized.

Press the key **▽** to change to the conditions of the LED indicators:

△ LED
S T A T U S **E**

Y e s / N o ? **Y/J**

[4103]
Block "Status of LED indicators"

Pressing the enter key **E** causes the relay to display the the question whether the states of the LED indicators (LED) shall be checked. Press the "Yes" –key **Y/J** to confirm, or the "No" –key **N** to abort.

Pressing the "Yes" –key **Y/J** makes the relay display the states of the LEDs. Each energized LED is marked by its number, LEDs which are not energized are marked with a –:

1: LED 1 is energized
2: LED 2 is energized
3: LED 3 is energized
4: LED 4 is energized
–: LED is **not** energized

The illustrated example shows that the LED 1 is energized, LED 2 is not energized, LED 3 is not energized, LED 4 is energized.

LED
- 2 - 4 △

Indication for

LED1, LED2, LED3, LED4

6.7.5 Testing the control commands

If the circuit breaker is to be controlled via the control functions of the device this control facility must be checked. A precondition is that the control function is switched *ON* (refer to Section 6.3.11).

Before control operations are carried out, it must have been ensured that switching is allowed under the actual operating conditions of the plant. If necessary, the breaker must be isolated at both sides.

The circuit breaker is closed and tripped using the device's front panel as described in Section 6.5.2.

If the circuit breaker does not respond to the control commands, check that the control functions are allocated to the respective output relays that control the breaker (FNo 4540 and 4641), during marshalling (Section 5.5.3).

If the breaker is to be controlled via the serial interface, this must be checked, too.

Blocking the control facility by energizing the respective blocking input (FNo 4632) must be checked as well, if used.

6.7.6 Tripping test including circuit breaker

Time overcurrent protection 7SJ602 allows simple checking of the tripping circuit and the circuit breaker. For this, the circuit breaker can be tripped by initiation from the operator keyboard or via the operator interface. If the internal auto-reclose system is activated, a trip–close test cycle is also possible.

Tests can be performed in address block 40. This block is reached by pressing the key ∇ three times so that the block "ADDITION FUNCTION" (additional functions) is displayed. Change to the second operation level by the key \triangleright ; "DATE/TIME" is displayed. Key ∇ is pressed until the display shows the test block "CB–TEST".

When the relay is operated from a personal computer by means of the protection data processing program DIGSI[®], the test items are identified by a four-digit address number. In the following clarifications, this number is indicated at the beginning of the explanations in brackets.

6.7.6.1 TRIP–CLOSE test cycle

Prerequisite for the start of a trip–close test cycle is that the integrated auto-reclose function be programmed as *EXIST* (address block 00) and switched on (address block 34).

A TRIP–CLOSE test cycle is also possible with an external auto-reclose system. Since in this case, however, 7SJ602 only gives the tripping command, the procedure shall be followed as described in Section 6.7.4.2.

If the circuit breaker auxiliary contacts advise the relay, through a binary input, of the circuit breaker position, the test cycle can only be started when the circuit breaker is closed. This additional security feature should not be omitted.



DANGER!

A successfully started test cycle will lead to closing of the circuit breaker!

The individual test item is reached with the key \triangleright in the next operation level.

Prerequisites for the start of test are that no protective function fault detector has picked up and that the conditions for reclose (e.g. AR not blocked) are fulfilled. Codeword input is necessary. The circuit breaker test feature must have been allocated to the trip relay during marshalling.

The relay displays the test sequence in the second display line.

\triangleleft

C B - T E S T
T R P - C L O

 \triangleright

[4300]
Block "Test of circuit breaker – Trip–Close–Cycle"

\triangleleft

C B - T E S T
T R P - C L O ?

E

[4304]
After confirmation with the enter key **E** the relay requests for codeword input. After correct codeword input, repeat confirmation with the enter key **E**. The relay checks whether breaker test is permitted or one of the following obstacles is detected:

R U N N I N G
F A U L T
C B O P E N !

- a circuit breaker test is already running
- a system fault is in progress
- the breaker signals via a binary input that it is open

If none of the above mentioned reasons to refuse is present, the test is started. The following messages may occur during the test:

A B O R T E D	– circuit breaker test is aborted
U N S U C C .	– circuit breaker test has been unsuccessful; breaker has not opened
E X E C U T E D	– circuit breaker test executed
C B n . o p n	– breaker is not open (before reclosing)

6.7.6.2 Live tripping of the circuit breaker

To check the tripping circuits, the circuit breaker can be tripped by 7SJ602 independently on whether an auto-reclosure will occur or not. However, this test can also be made with an external auto-reclose relay.

If the circuit breaker auxiliary contacts advise the relay, through a binary input, of the circuit breaker position, the test can only be started when the circuit breaker is closed. This additional security feature should not be omitted when an external auto-reclose relay is present.

The individual test item is reached with the key \triangleright in the next operation level.



DANGER!

A successfully started test cycle may lead to closing of the circuit breaker if an external auto-reclosure relay is used!

A prerequisite for starting the test is that no protection function of the relay be picked up. Codeword input is necessary. The circuit breaker test feature must have been allocated to the trip relay during marshalling.

The relay displays the test sequence in the second display line.

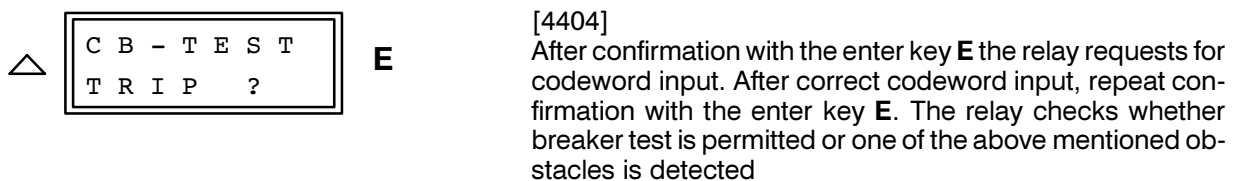

If none of the reasons to refuse is present, the test is started.

6.8 Putting the relay into operation

All setting values should be checked again, in case they were altered during the tests. Particularly check that all desired protection and ancillary functions have been programmed in the configuration parameters (address blocks 00 and 01, refer Section 5.4) and all desired protection functions have been switched *ON*.

Stored indications on the front plate should be reset by pressing the key "N" on the front so that from then on only real faults are indicated. During pushing the RESET button, the LEDs on the front will light up (except the "Blocked" –LED); thus, a LED test is performed at the same time.

Check that the module is properly inserted and fixed. The green LED must be on on the front; the red LED must not be on.

All terminal screws – even those not in use – must be tightened.

If a test switch is available, then this must be in the operating position.

The time overcurrent protection relay is now ready for operation.

7 Maintenance and fault tracing

Siemens digital protection relays are designed to require no special maintenance. All measurement and signal processing circuits are fully solid state and therefore completely maintenance free. Input modules are even static, relays are hermetically sealed or provided with protective covers.

As the protection is almost completely self-monitored, hardware and software faults are automatically annunciated. This ensures the high availability of the relay and allows a more corrective rather than preventive maintenance strategy. Tests at short intervals become, therefore, superfluous.

With detected hardware faults the relay blocks itself; drop-off of the availability relay signals "equipment fault" (when marshalled).

Recognized software faults cause the processor to reset and restart. If such a fault is not eliminated by restarting, further restarts are initiated. If the fault is still present after three restart attempts the protective system will switch itself out of service and indicate this condition by the red LED "Blocked" on the front plate. Drop-off of the availability relay signals "equipment fault".

The reaction to defects and indications given by the relay can be individually and in chronological sequence read off as operational annunciations under the address block 81, for defect diagnosis (refer to Section 6.4.2).

7.1 Routine checks

Routine checks of characteristics or pick-up values are not necessary as they form part of the continuously supervised firmware programs. The planned maintenance intervals for checking and maintenance of the plant can be used to perform operational testing of the protection equipment. This maintenance serves mainly for checking the interfaces of the unit, i.e. the coupling with the plant. The following procedure is recommended:

- Read-out of operational values (address block 84) and comparison with the actual values for checking the analog interfaces.
- Simulation of an internal short-circuit with $4 \times I_N$ for checking the analog input at high currents.



Warning

Hazardous voltages can be present on all circuits and components connected with the supply voltage or with the measuring and test quantities!



Caution!

Test currents larger than 4 times I_N may overload and damage the relay if applied continuously (refer to Section 3.1.1 for overload capability). Observe a cooling down period!

- Circuit breaker trip circuits are tested by actual live tripping. Respective notes are given in Section 6.7.6.

7.2 Fault tracing

If the protective device indicates a defect, the following procedure is suggested:

If none of the LEDs on the front plate of the module is on, then check:

- Has the module been properly pushed in and locked?
- Is the auxiliary voltage available with the correct polarity and of adequate magnitude, connected to the correct terminals (General diagrams in Appendix A)?
- Has the mini-fuse in the power supply section blown (see Figure 7.1)? If appropriate, replace the fuse according to Section 7.2.1.

If the red fault indicator "Blocked" on the front is on and the green ready LED remains dark, the device has recognized an internal fault. Re-initialization of the protection system could be tried by switching the d.c. auxiliary voltage off and on again. This, however, results in loss of fault data and messages and, if a parameterizing process has not yet been completed, the last parameters are not stored. Additionally, date and time must be set again (refer to Section 6.5.1).

7.2.1 Replacing the mini-fuse

- Select a replacement fuse 5×20 mm. Ensure that the rated value, time lag (slow) and code letters are correct. (Figure 7.1).
- Prepare area of work: provide conductive surface for the module.
- Slip away the covers at top and bottom of the housing in order to gain access to the fixing screws of the module. Unscrew these screws.
- If the device has a communication modul at the bottom side, this must be removed after unscrewing the six fixing screws.

Warning

Hazardous voltages can be present in the device even after disconnection of the supply voltage or after removal of the modules from the housing (storage capacitors)!

- Pull out the module by taking it at the front cover and place it on a surface which is suited to electrostatically endangered components (EEC);



Caution!

Electrostatic discharges via the component connections, the PCB tracks or the connecting pins of the modules must be avoided under all circumstances by previously touching an earthed metal surface.

- Remove blown fuse from the holder (Figure 7.1).
- Fit new fuse into the holder (Figure 7.1).
- Insert draw-out module into the housing;
- Fix the module into the housing by tightening the two fixing screws.
- If the device has a communication modul at the bottom side, this must be reinserted and the screws must be tightened.
- Reinsert the covers.

Switch on the device again. If a power supply failure is still signalled, a fault or short-circuit is present in the internal power supply. The device should be returned to the factory (see Chapter 8).

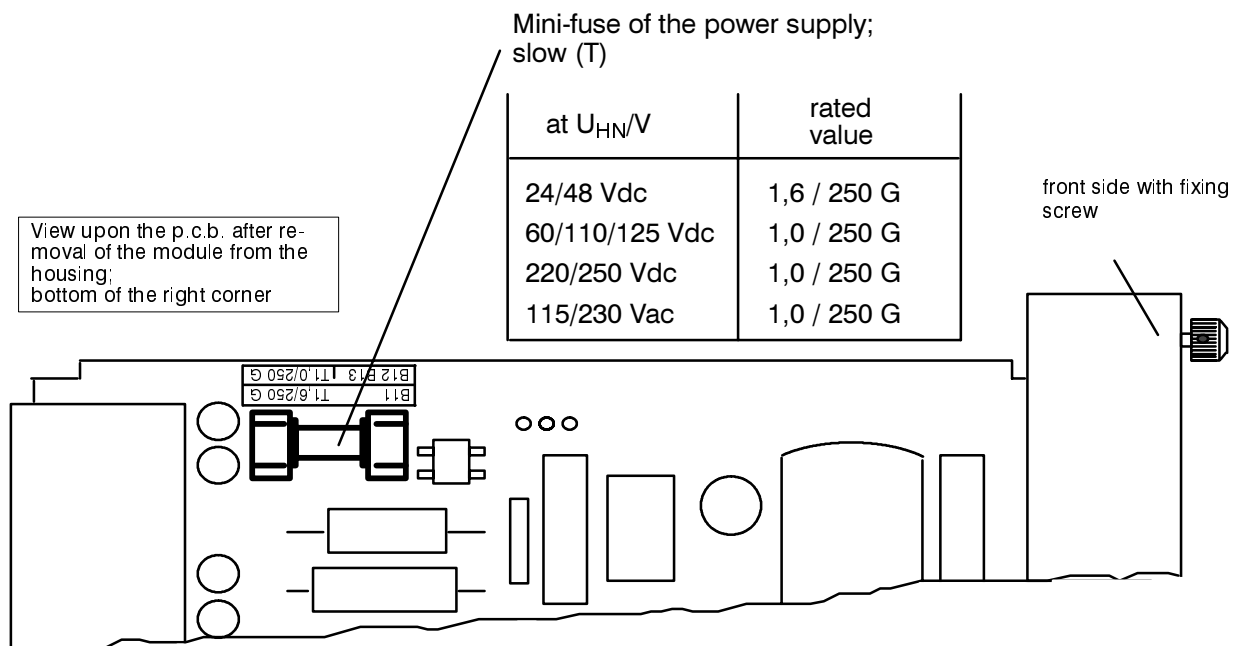

Figure 7.1 Mini-fuse of the power supply

8 Repairs

Repair of defective modules is not recommended at all because specially selected electronic components are used which must be handled in accordance with the procedures required for **Electrostatically Endangered Components (EEC)**. Furthermore, special manufacturing techniques are necessary for any work on the printed circuit boards in order to do not damage the bath-soldered multilayer boards, the sensitive components and the protective finish.

Therefore, if a defect cannot be corrected by operator procedures such as described in Chapter 7, it is recommended that the complete relay should be returned to the manufacturer. Use the original packaging for return. If alternative packing is used, this must provide the degree of protection against mechanical shock, as laid down in IEC 60255–21–1 class 2 and IEC 60255–21–2 class 1.

If it is unavoidable to replace individual modules, it is imperative that the standards related to the handling of **Electrostatically Endangered Components** are observed.



Warning

Hazardous voltages can be present in the device even after disconnection of the supply voltage or after removal of the module from the housing (storage capacitors)!



Caution!

Electrostatic discharges via the component connections, the PCB tracks or the connecting pins of the modules must be avoided under all circumstances by previously touching an earthed metal surface. This applies equally for the replacement of removable components, such as EPROM or EEPROM chips. For transport and returning of individual modules electrostatic protective packing material must be used.

Components and modules are not endangered as long as they are installed within the relay.

Should it become necessary to exchange any device or module, the complete parameter assignment should be repeated. Respective notes are contained in Chapter 5 and 6.

9 Storage

Solid state protective relays shall be stored in dry and clean rooms. The limit temperature range for storage of the relays or associated spare parts is -25 °C to $+55\text{ °C}$ (refer Section 3.1.4 under the Technical data), corresponding to -12 °F to 130 °F .

The relative humidity must be within limits such that neither condensation nor ice forms.

It is recommended to reduce the storage temperature to the range $+10\text{ °C}$ to $+35\text{ °C}$ (50 °F to 95 °F); this prevents from early ageing of the electrolytic capacitors which are contained in the power supply.

For very long storage periods, it is recommended that the relay should be connected to the auxiliary voltage source for one or two days every other year, in order to regenerate the electrolytic capacitors. The same is valid before the relay is finally installed. In extreme climatic conditions (tropics) pre-warming would thus be achieved and condensation avoided.

Before initial energization with supply voltage, the relay shall be situated in the operating area for at least two hours in order to ensure temperature equalization and to avoid humidity influences and condensation.

Appendix

- A General diagrams**

- B Current transformer circuits**

- C Operation structure, Tables**

A General diagram

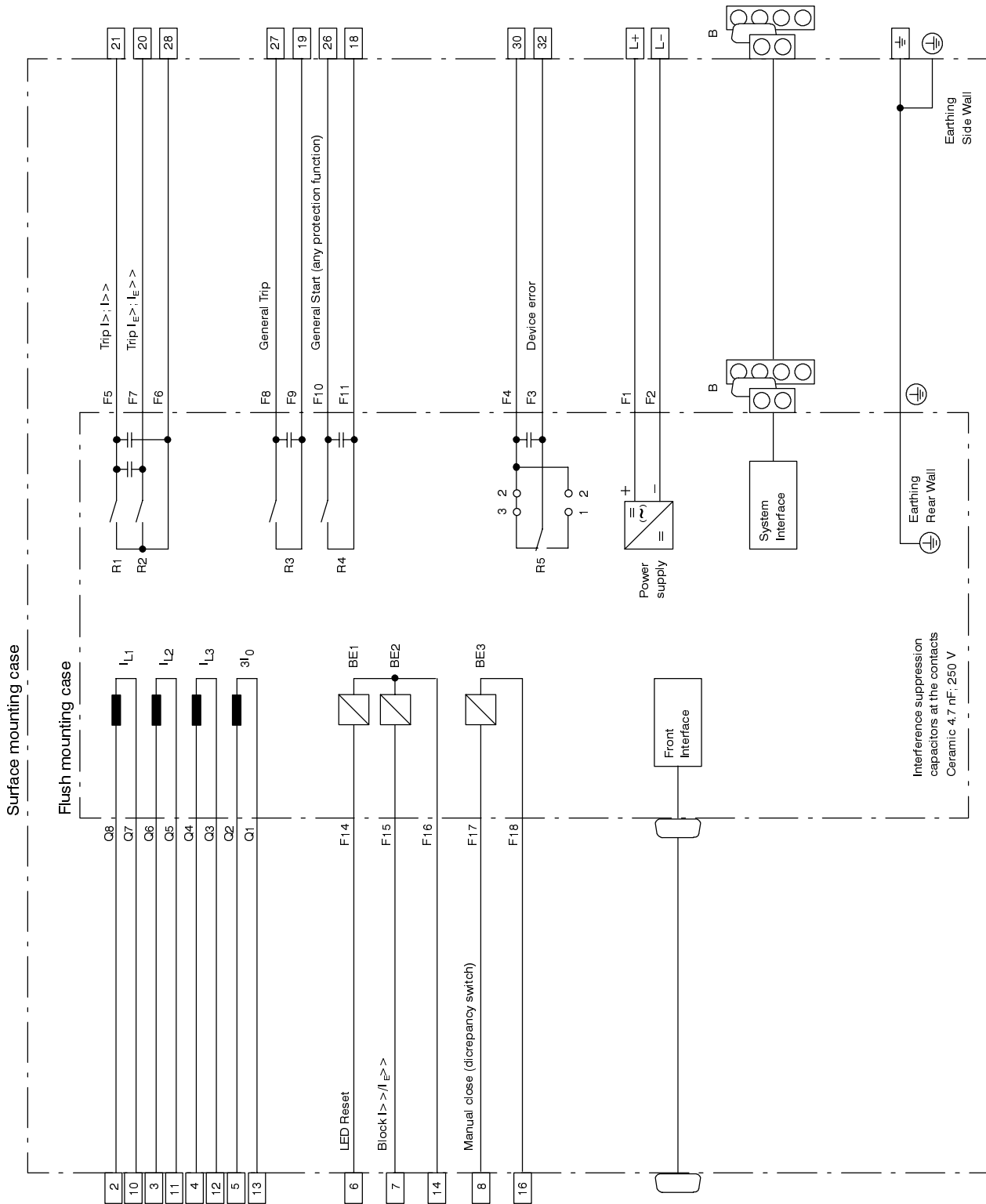

Figure A.1 General diagram of time overcurrent protection relay 7SJ600

B Current transformer circuits

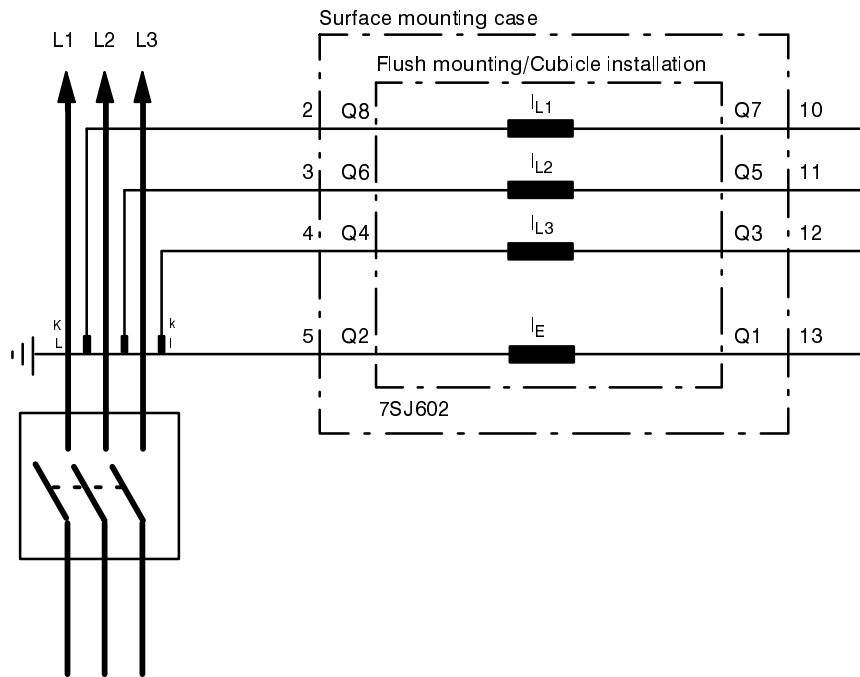

Figure B.1 **3 c.t. connection**, normal connection for all networks

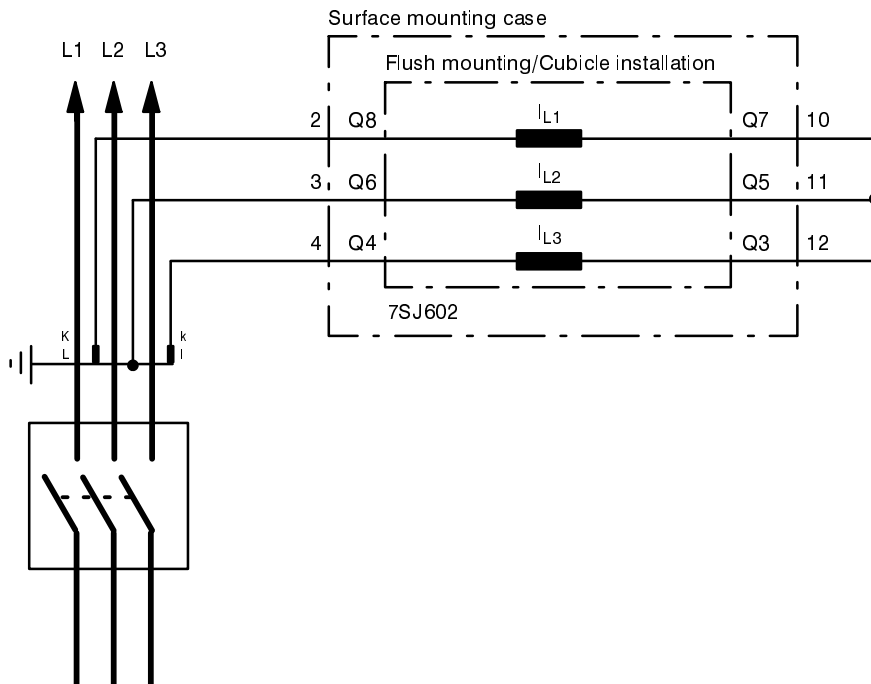

Figure B.2 **2 c.t. connection** only for isolated or compensated systems

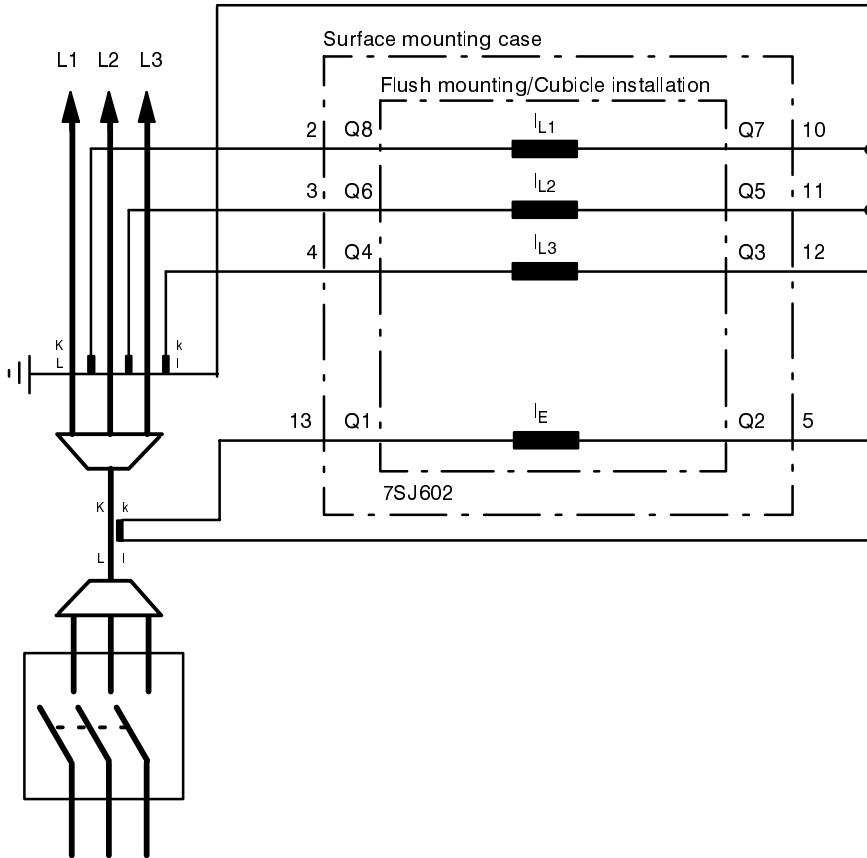

Figure B.3 3 c.t. connection with separate residual c.t. for earth currents

C Operation structure, Tables

Table C.1 Menu structure 156

Table C.2 Annunciations for LSA (according IEC 60870–5–103) 165

Table C.3 Annunciations for PC, LC-display, and binary inputs/outputs 166

Table C.4 Reference table for functional parameters 169

Table C.5 Reference table for configuration parameters 176

NOTE: The following tables list all data which are available in the maximum complement of the device. Dependent on the ordered model, only those data may be present which are valid for the individual version.

NOTE: The actual tables are attached to the purchased relay.

Menu Structure of 7SJ602

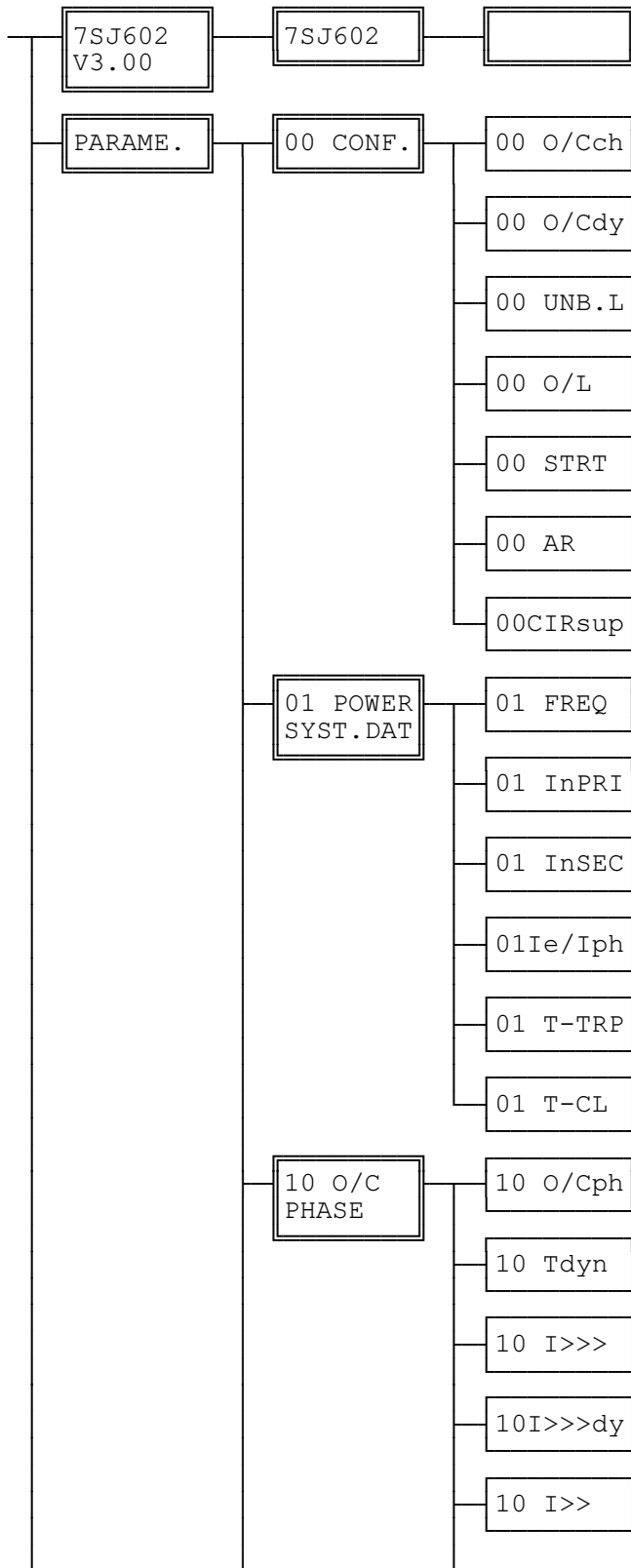

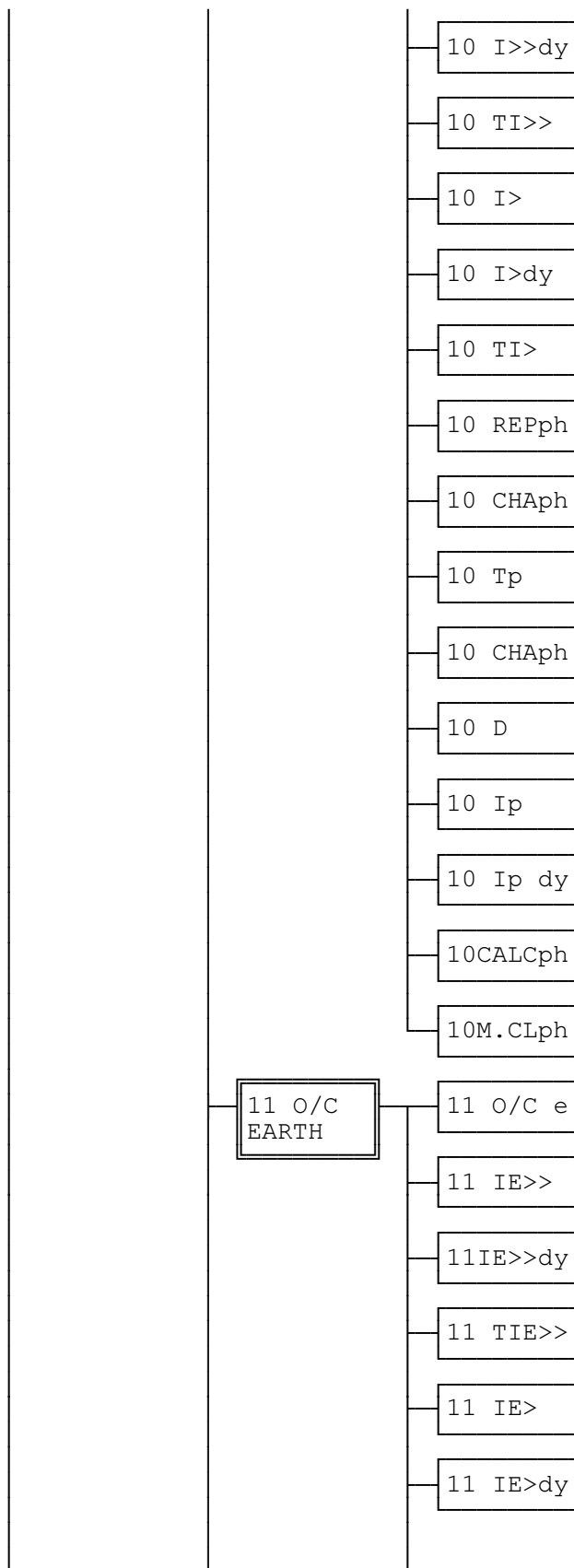

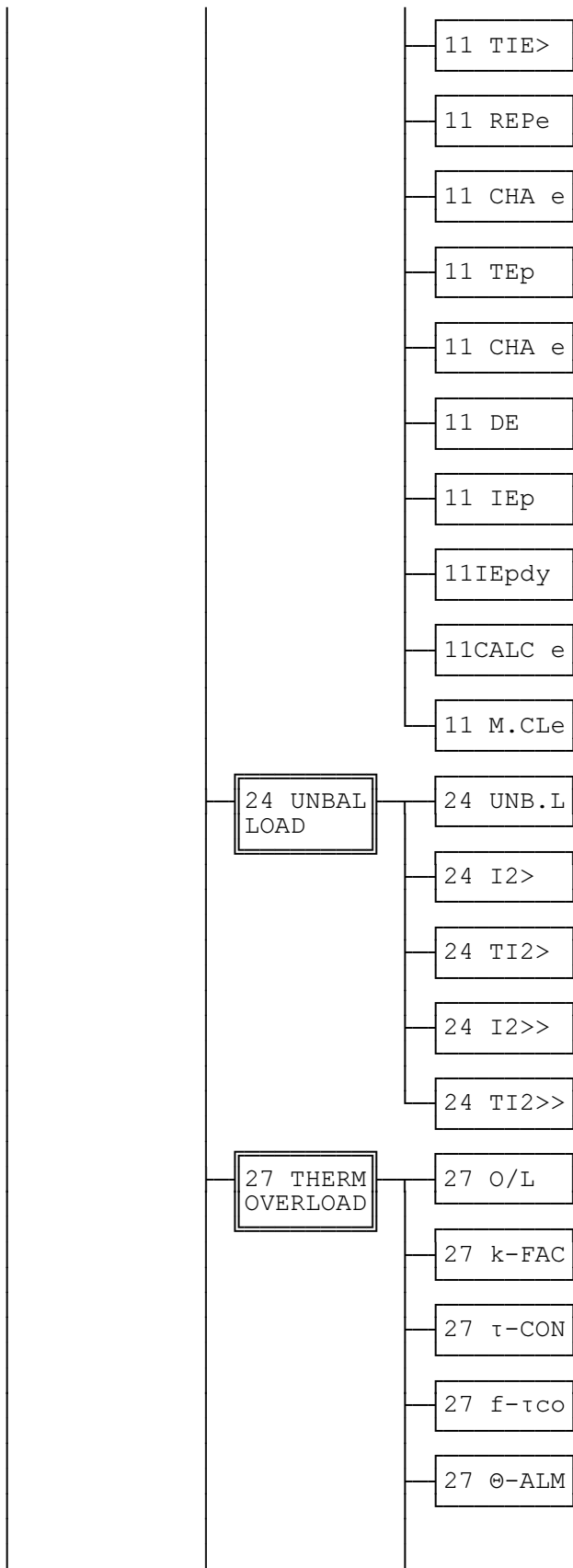

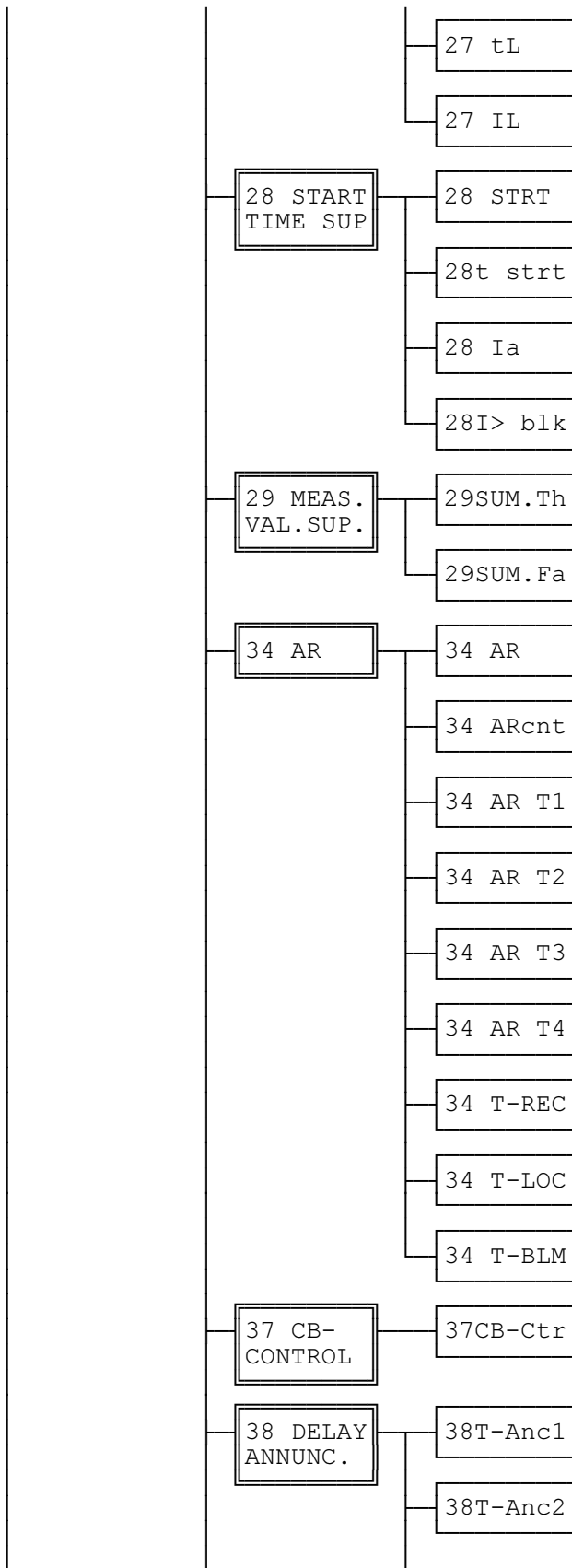

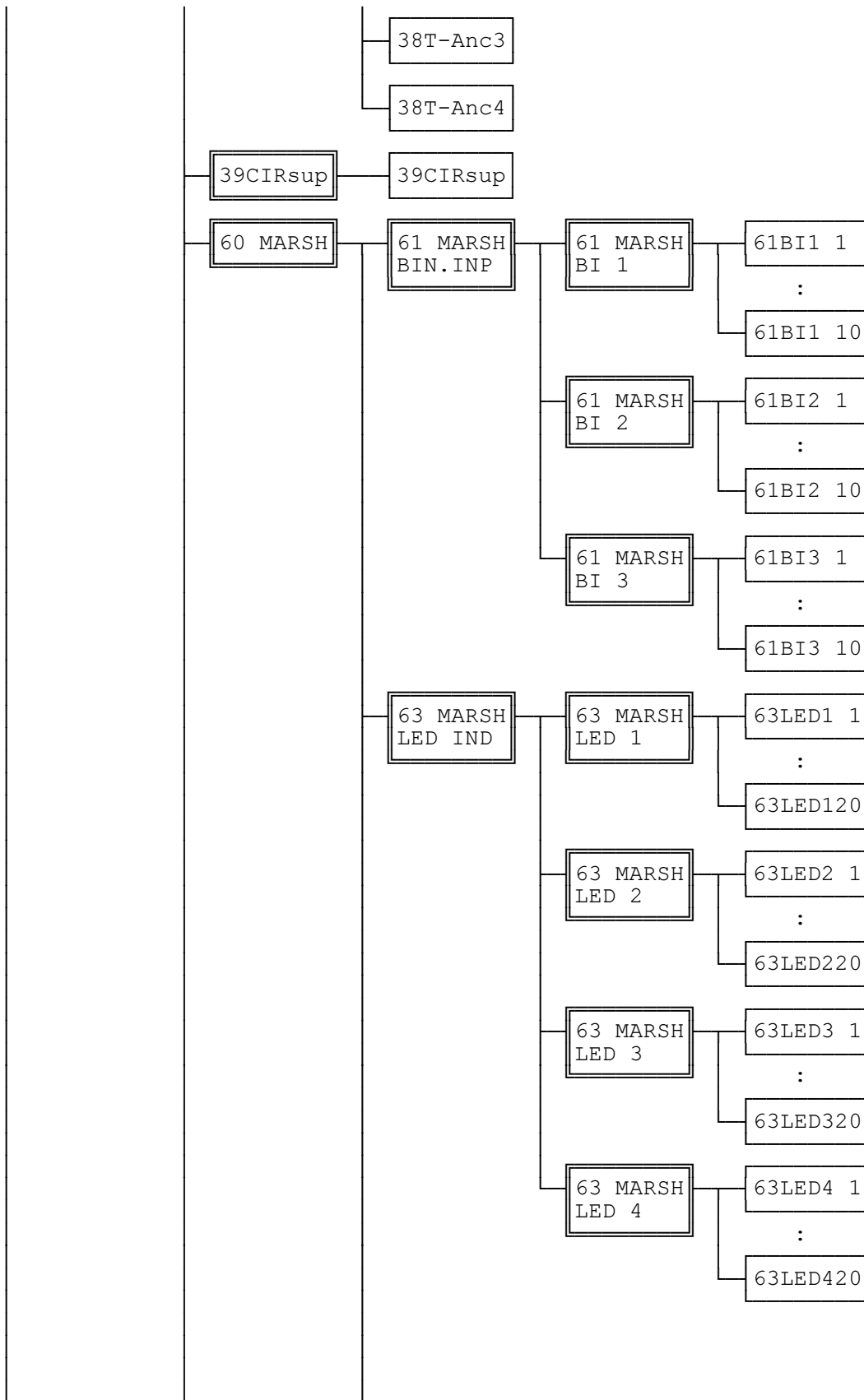

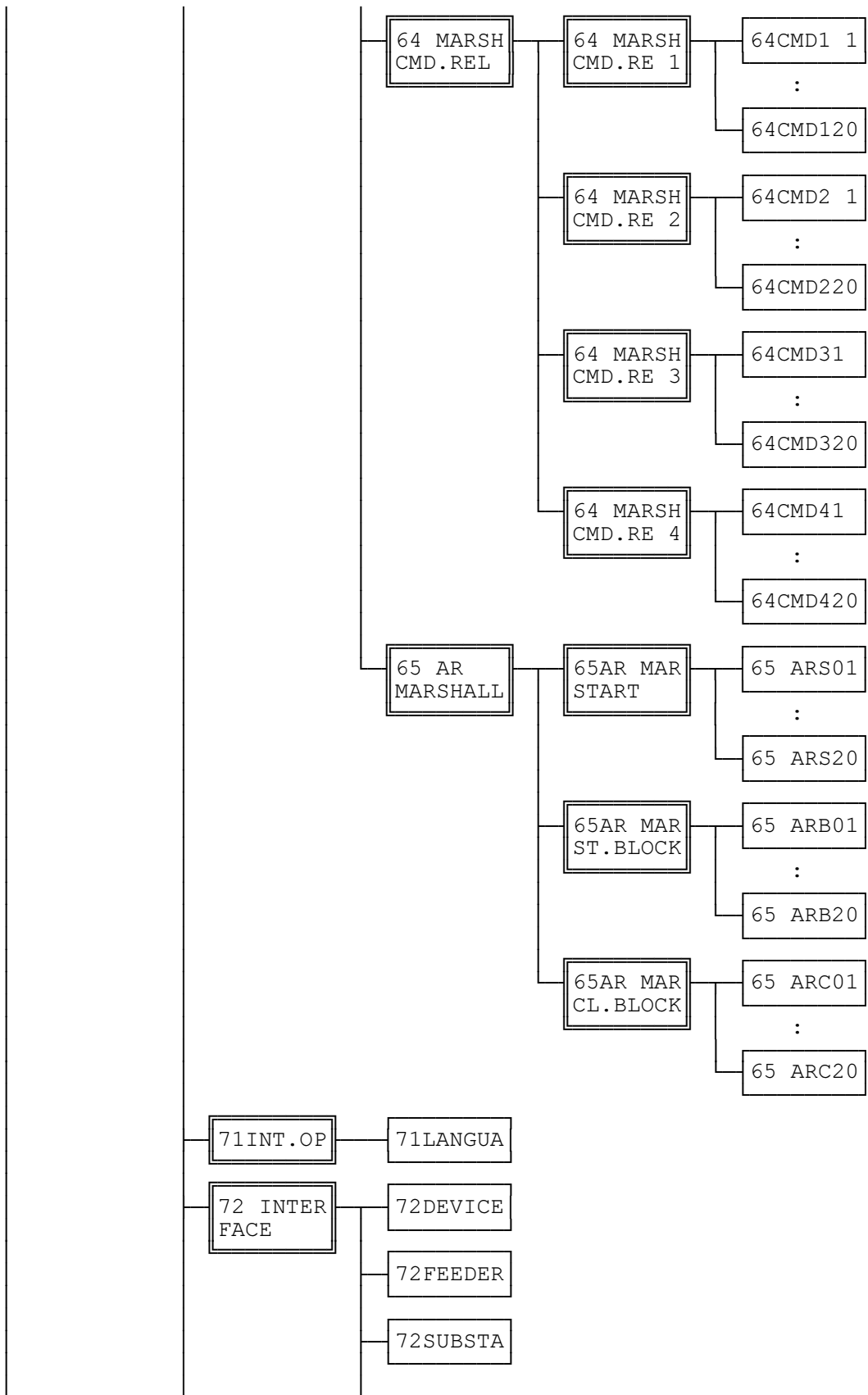

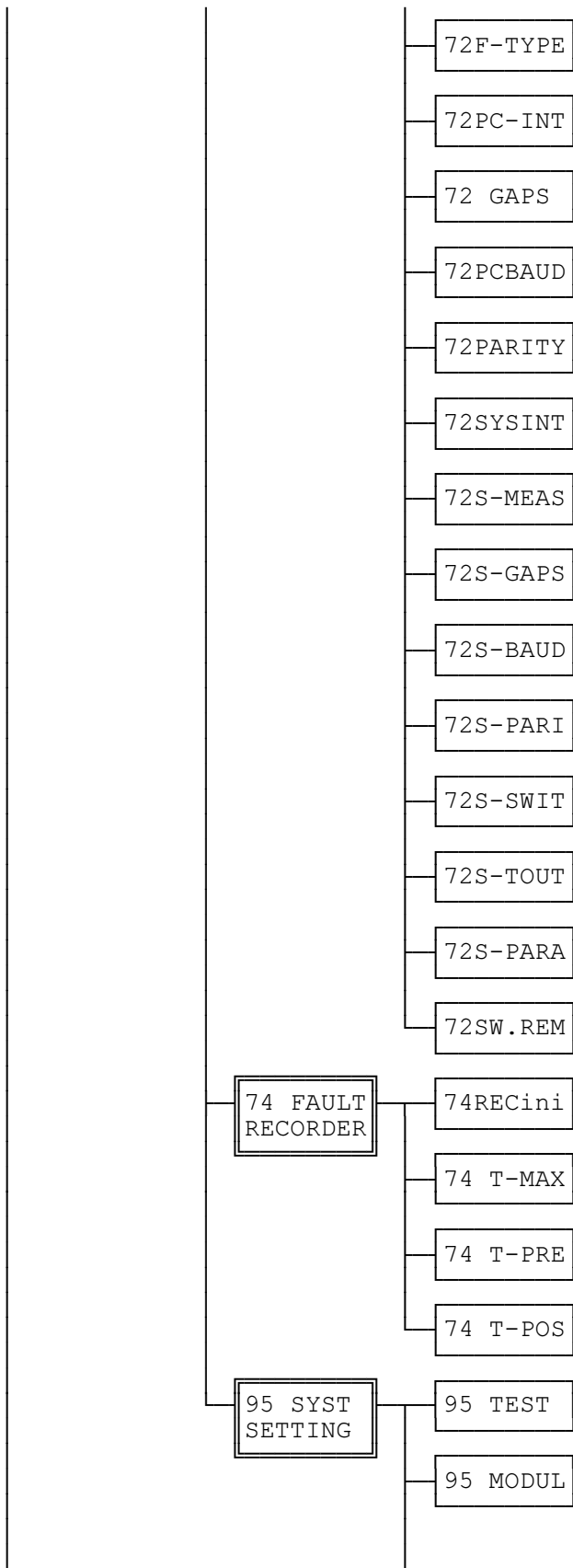

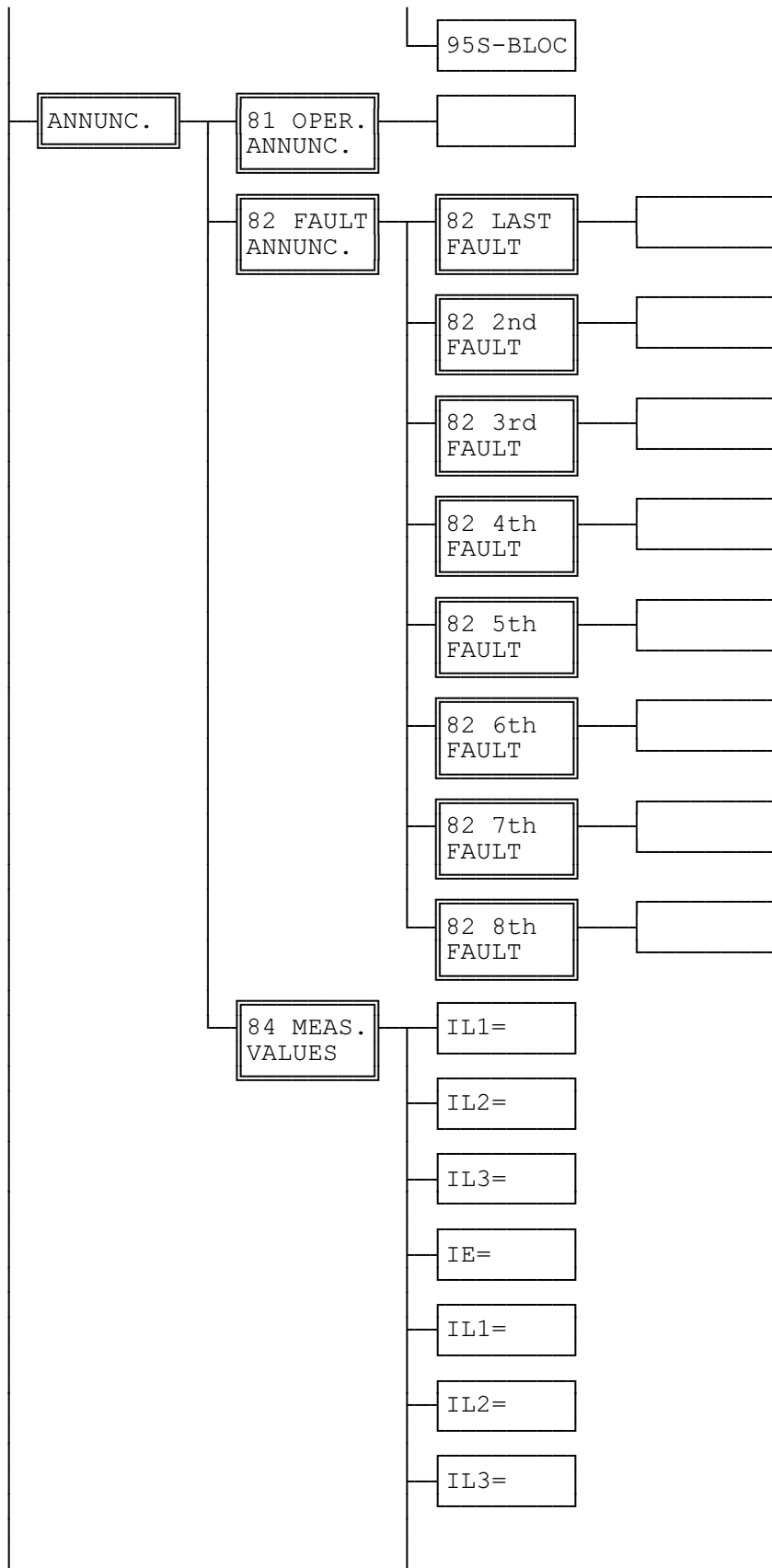

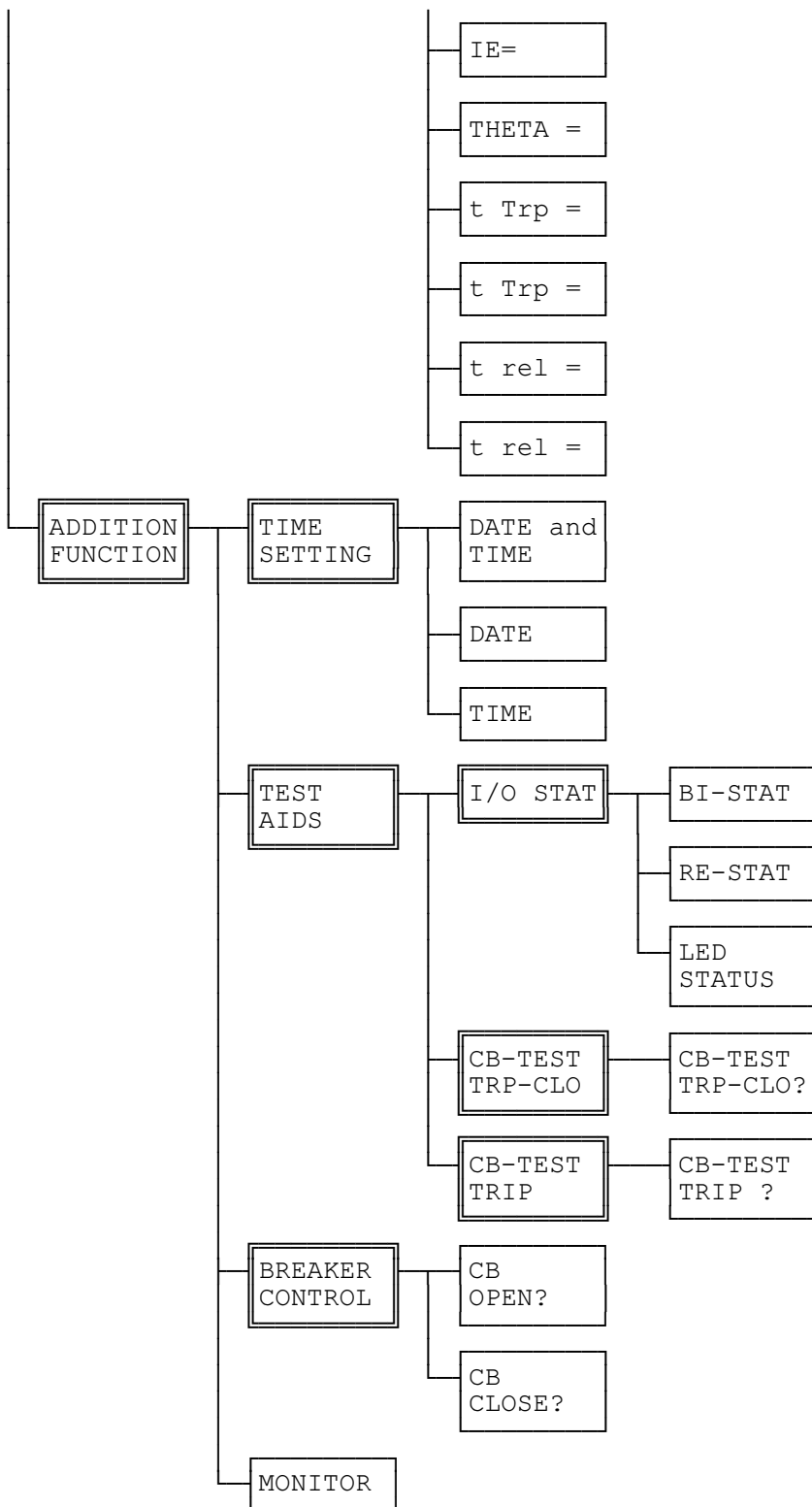

Annunciations 7SJ602 for LSA (according to IEC 60870-5-103)

FNo. - Function number of annunciation
 Op/Ft - Operation/Fault annunciation
 C/CG: Coming/Coming and Going annunciation
 V : Annunciation with Value
 M : Measurand
 LSA No.- Number of annunciation for former LSA (not applicable)

according to IEC 60870-5-103:

CA - Compatible Annunciation
 GI - Annunciation for General Interrogation
 BT - Binary Trace for fault recordings
 Typ - Function type (p: according to the configured "Function type")
 Inf - Information number

FNo.	Meaning	Ann.		LSA No.	IEC 60870-5-103				
		Op	Ft		CA	GI	BT	Typ	Inf
11	>User definable annunciation No 1	CG			CA	GI		p	27
12	>User definable annunciation No 2	CG			CA	GI		p	28
13	>User definable annunciation No 3	CG			CA	GI		p	29
14	>User definable annunciation No 4	CG			CA	GI		p	30
61	Logging and measuring transm. blocked	CG			CA			p	20
162	Failure current sum monitor Sum(I)	CG						135	182
501	General fault detection of the device		CG		CA	GI	BT	p	84
511	General trip of the device		C		CA		BT	p	68
602	Current in phase L2 [%] =		M		CA			p	144
4632	>Block breaker control function	CG				GI		101	32
4640	CLOSE command for breaker (control)	C						101	120
4641	OPEN command for breaker (control)	C						101	121

Annunciations 7SJ602 for PC, LC-display and binary inputs/outputs

FNo. - Function number of annunciation
 Op/Ft - Operation/Fault annunciation
 C/CG: Coming/Coming and Going annunciation
 M : Measurand
 I - can be marshalled to binary input
 O - can be marshalled to binary output (LED, signal/trip relay)

FNo.	Text	Meaning	Op	Ft	I	O
1	not all.	Not allocated			I	O
5	>LED r.	>Reset LED indicators			I	O
11	>Annu.1	>User defined annunciation 1	CG		I	O
12	>Annu.2	>User defined annunciation 2	CG		I	O
13	>Annu.3	>User defined annunciation 3	CG		I	O
14	>Annu.4	>User defined annunciation 4	CG		I	O
16	>SysMMb	>Block. of monitoring dir. via sys.-int	CG		I	O
52	operat.	Any protection operative	CG			O
53	Res.FCB	Reset frame count bit				
54	ResetKE	Reset communication unit				
56	Init.st	Initial start of processor system				
57	GI-end	End of general interrogation				
58	Time sy	Time synchronization				
60	LED res	LED Reset	C			
61	Meas.Bl	Logging and measuring functions blocked	CG			O
63	PCviaSy	PC operation via system interface				
75		For internal use only				
76		For internal use only				
77		For internal use only				
80	SigStör	For internal use only				
81	SigBef.	For internal use only				
83	SigTest	For internal use only				
110	ANNlost	Annunciations lost (buffer overflow)	C			
111	PCannLT	Annunciations for PC lost	C			
112	LSAanLT	Annunciations for LSA lost				
113	TAGlost	Fault tag lost				
115	ANNovfl	Fault annunciation buffer overflow		C		
129	IECstIN	IEC state invalid				
159	LSAdist	LSA (system interface) disrupted				
162	FailΣI	Failure: Current summation supervision	CG			O
203	REC del	Fault recording data deleted	C			
244		Diff. time of clock synchronism				
301	Sys.Flt	Fault in the power system	C	C		O
302	FAULT	Flt. event w. consecutive no.	C	C		O
356	>mCLOSE	>Manual close	CG		I	O
501	FT det	General fault detection of device		CG		O
511	DEV.Trp	General trip of device		C		O
521	IL1	Interrupted current: Phase L1(I/In)		C		
522	IL2	Interrupted current: Phase L2(I/In)		C		
523	IL3	Interrupted current: Phase L3(I/In)		C		
563	CBA sup	CB alarm suppressed				O
601	IL1=	Current in phase IL1 [%] =	M			
602	IL2=	Current in phase IL2 [%] =	M			
603	IL3=	Current in phase IL3 [%] =	M			
604	IE=	IE[%]=	M			
651	IL1=	Current in phase IL1 =	M			
652	IL2=	Current in phase IL2 =	M			
653	IL3=	Current in phase IL3 =	M			

FNo.	Text	Meaning	Op	Ft	I	O
654	IE=	Operational measurement: IEa=	M			
1157	>CBClo	>Circuit breaker closed	CG		I	O
1174	CBtest	Circuit breaker test in progress	CG			O
1185	CBtpTST	Circuit breaker test: Trip 3pole	CG			O
1188	CBtWAR	Circuit breaker test: Trip w. reclosure	CG			O
1501	>O/L on	>Switch on thermal overload protection			I	O
1502	>O/Loff	>Switch off thermal overload protection			I	O
1503	>O/Lblk	>Block thermal overload protection			I	O
1511	O/L off	Thermal overload prot. is switched off	CG			O
1512	O/L blk	Thermal overload protection is blocked	CG			O
1513	O/L act	Thermal overload protection is active	CG			O
1516	O/L wrn	Thermal overload prot.: Thermal warning	CG	CG		O
1518	O/L p/u	Thermal overload prot.: Pick-up	CG	CG		O
1521	O/L Trp	Thermal overload protection trip		C		O
1530	THETA =	Operating temperature =	M			
1531	t Trp =	O/L: estimated time to trip	M			
1532	t Trp =	O/L: estimated time to trip	M			
1533	t rel =	O/L: estimated time to release closing	M			
1534	t rel =	O/L: estimated time to release closing	M			
1701	>O/Cpon	>Switch on O/C protection phase			I	O
1702	>O/Cpof	>Switch off O/C protection phase			I	O
1704	>O/Cpbk	>Block overcurrent protection phases			I	O
1711	>O/Ceon	>Switch on overcurrent protection earth			I	O
1712	>O/Ceof	>Switch off overcurrent protec. earth			I	O
1714	>O/Cebk	>Block overcurrent protection earth			I	O
1721	>I>>blk	>Overcurrent protection:block stage I>>	CG		I	O
1722	>I> blk	>Overcurrent protection:block stage I>	CG		I	O
1723	>Ip blk	>Overcurrent protection:block stage Ip	CG		I	O
1724	>IE>>bk	>Overcurrent protec.: block stage IE>>	CG		I	O
1725	>IE> bk	>Overcurrent protection:block stage IE>	CG		I	O
1726	>IEp bk	>Overcurrent protection:block stage IEp	CG		I	O
1727	>C/O	>C/O of overcurrent fault detec. level			I	O
1751	O/Cpoff	Overcurrent prot. phase is switched off	CG			O
1752	O/Cpblk	Overcurrent prot. phase is blocked	CG			O
1753	O/Cpact	Overcurrent prot. phase is active	CG			O
1756	O/Ceof	O/C protection earth is switched off	CG			O
1757	O/Ceblk	O/C protection earth is blocked	CG			O
1758	O/Ceact	O/C protection earth is active	CG			O
1762	O/C L1	O/C fault detection phase L1				O
1763	O/C L2	O/C fault detection phase L2				O
1764	O/C L3	O/C fault detection phase L3				O
1765	O/C E	O/C fault detection earth				O
1771	FD L1	O/C fault detection L1 only		C		
1772	FD L1E	O/C fault detection L1-E		C		
1773	FD L2	O/C fault detection L2 only		C		
1774	FD L2E	O/C fault detection L2-E		C		
1775	FD L12	O/C fault detection L1-L2		C		
1776	FD L12E	O/C fault detection L1-L2-E		C		
1777	FD L3	O/C fault detection L3 only		C		
1778	FD L3E	O/C fault detection L3-E		C		
1779	FD L13	O/C fault detection L1-L3		C		
1780	FD L13E	O/C fault detection L1-L3-E		C		
1781	FD L23	O/C fault detection L2-L3		C		
1782	FD L23E	O/C fault detection L2-L3-E		C		
1783	FD L123	O/C fault detection L1-L2-L3		C		
1784	FDL123E	O/C fault detection L1-L2-L3-E		C		
1785	FD E	O/C fault detection E only		C		
1800	FD I>>	O/C fault detection stage I>>	CG			O

FNo.	Text	Meaning	Op	Ft	I	O
1805	Trp I>>	O/C protection I>> phase trip		C		0
1810	FD I>	O/C fault detection stage I>		CG		0
1815	Trip I>	O/C protection I> phase trip		C		0
1820	FD Ip	O/C fault detection Ip		CG		0
1825	Trip Ip	O/C protection Ip phase trip		C		0
1831	FD IE>>	O/C fault detection IE>> earth		CG		0
1833	TrpIE>>	O/C protection IE>> earth trip		C		0
1834	FD IE>	O/C fault detection IE> earth		CG		0
1836	Trp IE>	O/C protection IE> earth trip		C		0
1837	FD IEp	O/C fault detection IEp earth		CG		0
1839	Trp IEp	O/C protection IEp earth trip		C		0
1850	FD dyn	O/C prot. : dynamic parameters active	CG			0
2701	>AR on	>AR: Switch on auto-reclose function			I	0
2702	>AR off	>AR: Switch off auto-reclose function			I	0
2732	>AR St.	>AR: Start external	CG	CG	I	0
2733	>ARblSt	>AR: External Blocking of Start	CG	CG	I	0
2734	>ARblCl	>AR: External Blocking of reclosure	CG	CG	I	0
2736	AR act.	AR: Auto reclosure is active	CG			0
2781	AR off	AR: Auto-reclose is switched off	CG			0
2801	AR i pg	AR: Auto-reclose in progress		CG		0
2851	AR ClCm	AR: Close command from auto-reclose		CG		0
2863	AR dTrp	AR: Definitive trip		CG		0
2872	AR Strt	AR: Start		CG		0
2873	AR blSt	AR: blocked		CG		0
2874	AR blCl	AR: Reclosure blocked		CG		0
2875	AR blMC	AR: Blocked by manual close	CG			0
2876	AR DT	AR: Dead time	C	C		0
4632	>SWblo.	>Switching authorization: blocked			I	0
4640	Q0 Clo.	Control-Close-Command CB-Q0	C			0
4641	Q0 Trp.	Control-Trip-Command CB-Q0	C			0
4642	Q0 Ctr.	Control-Command CB-Q0				0
5143	>I2 blk	>Block unbalanced load protection			I	0
5144	>revPhR	>Reversed phase rotation	CG		I	0
5151	I2 off	Unbalanced load prot. is switched off	CG			0
5152	I2 blk	Unbalanced load protection is blocked	CG			0
5153	I2 act	Unbalanced load protection is active	CG			0
5159	FD I2>>	Unbalanced load: Fault detec. I2>>		CG		0
5165	FD I2>	Fault detection neg. seq. I (I2>)		CG		0
5170	Trp I2	neg. seq. I. (I2) prot.: Trip		C		0
6757	TrpI>>>	O/C protection I>>> phase trip		CG		0
6758	>I>>>bk	>inst. high set prot.: block stage I>>>	CG		I	0
6801	>SRT bk	>Block starting time supervision			I	0
6811	SRT off	Starting time supervision off	CG			0
6812	SRT blk	Starting time supervision blocked	CG			0
6813	SRT act	Starting time supervision active	CG			0
6821	SRT Trp	Trip by supervision of starting time	CG	C		0
6851	>SUP bk	>Blocking trip circuit supervision			I	0
6852	>TrpRel	>Trip circuit supervision: Trip relay	CG		I	0
6853	>CBaux	>Trip circuit supervision: CB aux.	CG		I	0
6861	SUP off	Trip circuit supervision off	CG			0
6862	SUP blk	Trip circuit supervision blocked	CG			0
6863	SUP act	Trip circuit supervision active	CG			0
6864	SUPnoBI	TC superv. blocked: BI not marshalled	CG			0
6865	CIR int	Trip circuit interrupted	CG			0

Reference Table for Functional Parameters 7SJ602

PARAME. - PARAMETER SETTINGS

00 CONF. - SCOPE OF FUNCTIONS

00 O/Cch		Characteristic of O/C protection
def TIME	[]	Definite time
I>>> I>>	[]	I>>> I>>
IEC inv.	[]	Inverse time
ANSI inv	[]	ANSI inv
IEC O/C	[]	IEC O/C
ANSI O/C	[]	ANSI O/C
nonEXIST	[]	Non-existent
00 O/Cdy		Temporary pick-up value change over (O/C-st.)
nonEXIST	[]	Non-existent
EXIST	[]	Existent
00 UNB.L		Unbalanced load protection
nonEXIST	[]	Non-existent
EXIST	[]	Existent
00 O/L		Thermal overload protection
nonEXIST	[]	Non-existent
pre LOAD	[]	With memory
no preLD	[]	Without memory
00 STRT		Supervision of starting time
nonEXIST	[]	Non-existent
EXIST	[]	Existent
00 AR		Internal auto-reclose function
nonEXIST	[]	Non-existent
EXIST	[]	Existent
00CIRsup		Trip circuit supervision
nonEXIST	[]	Non-existent
with 2BI	[]	No resist., 2 BI
bypass-R	[]	bypass resistor, 1 BI

01 POWER SYST.DAT - POWER SYSTEM DATA

01 FREQ		Rated system frequency
50 Hz	[]	fN 50 Hz
60 Hz	[]	fN 60 Hz
01 InPRI		Primary rated current
min. 10		A
max. 50000	_____	
01 InSEC		Secondary rated current
1A	[]	1A
5A	[]	5A
01Ie/Iph		Matching factor Ie/Iph for earth current
min. 0.010		
max. 5.000	_____	

01 T-TRP	Minimum trip command duration
min. 0.01	s
max. 32.00	_____
01 T-CL	Maximum close command duration
min. 0.01	s
max. 60.00	_____

10 O/C PHASE - O/C PROTECTION PHASE FAULTS

10 O/Cph	O/C protection for phase faults
ON	<input type="checkbox"/> on
OFF	<input type="checkbox"/> off
10 Tdyn	Duration of temporary pick-up value c/o
min. 0.1	s
max. 10000.0	_____
10 I>>>	Pick-up value of the high-set inst. I>>>
min. 0.3	I/In
max. 12.5/∞	_____
10I>>>dy	Pick-up val. of high-set ins. I>>> (dyn)
min. 0.3	I/In
max. 12.5/∞	_____
10 I>>	Pick-up value of the high-set stage I>>
min. 0.1	I/In
max. 25.0/∞	_____
10 I>>dy	Pick-up value of the high-set I>> (dyn)
min. 0.1	I/In
max. 25.0/∞	_____
10 TI>>	Trip time delay of the high-set stage I>>
min. 0.00	s
max. 60.00	_____
10 I>	Pick-up value of the overcurrent stage I>
min. 0.1	I/In
max. 25.0/∞	_____
10 I>dy	Pick-up value of the O/C stage I> (dyn)
min. 0.1	I/In
max. 25.0/∞	_____
10 TI>	Trip time delay of the overcurrent stage I>
min. 0.00	s
max. 60.00	_____
10 REPph	Measurement repetition
NO	<input type="checkbox"/> no
YES	<input type="checkbox"/> yes
10 CHAph	Characteristic of the O/C stage Ip
inverse	<input type="checkbox"/> Normal inverse
short in	<input type="checkbox"/> Very inverse
extr.inv	<input type="checkbox"/> Extremely inverse
long inv	<input type="checkbox"/> long inverse
never	<input type="checkbox"/> Never

10 Tp		Trip time delay inverse time O/C stage Ip
min. 0.05		s
max. 3.20	_____	
10 CHAph		Characteristic of the O/C stage Ip
inverse	<input type="checkbox"/>	Inverse
short in	<input type="checkbox"/>	Short inverse
long inv	<input type="checkbox"/>	Long inverse
mode inv	<input type="checkbox"/>	Moderately inverse
very inv	<input type="checkbox"/>	Very inverse
extr inv	<input type="checkbox"/>	Extremely inverse
def inv	<input type="checkbox"/>	Definite inverse
I-squaredT	<input type="checkbox"/>	I-squared-t
never	<input type="checkbox"/>	Never
10 D		Delayfactor of inverse phase-current protec.
min. 0.5		s
max. 15.0	_____	
10 Ip		Pick-up value inverse time O/C stage Ip
min. 0.1		I/In
max. 4.0	_____	
10 Ip dy		Pick-up value inverse time O/C stage Ip (dyn)
min. 0.1		I/In
max. 4.0	_____	
10CALCph		RMS format for inverse time O/C protection
noHARMON	<input type="checkbox"/>	Without harmonics
HARMONIC	<input type="checkbox"/>	With harmonics
10M.CLph		Manual close
I>>undel	<input type="checkbox"/>	I>> undelayed
I>undela	<input type="checkbox"/>	I> undelayed
Ip undel	<input type="checkbox"/>	Ip undelayed
INEFFECT	<input type="checkbox"/>	Ineffective

11 O/C EARTH - O/C PROTECTION EARTH FAULTS

11 O/C e		O/C protection for earth faults
ON	<input type="checkbox"/>	on
OFF	<input type="checkbox"/>	off
11 IE>>		Pick-up value of the high-set stage IE>>
min. 0.05		I/In
max. 25.00/∞	_____	
11IE>>dy		Pick-up value of high-set E/F stage IE>> (dyn)
min. 0.05		I/In
max. 25.00/∞	_____	
11 TIE>>		Trip time delay of the high-set stage IE>>
min. 0.00		s
max. 60.00	_____	
11 IE>		Pick-up value of the overcurrent stage IE>
min. 0.05		I/In
max. 25.00/∞	_____	

11 IE>dy	Pick-up value of def. time E/F IE> (dyn)
min. 0.05	I/In
max. 25.00/∞	_____
11 TIE>	Trip time delay of the overcurrent stage IE>
min. 0.00	s
max. 60.00	_____
11 REPe	Measurement repetition
NO	<input type="checkbox"/> no
YES	<input type="checkbox"/> yes
11 CHA e	Characteristic of the O/C stage IEp
inverse	<input type="checkbox"/> Normal inverse
short in	<input type="checkbox"/> Very inverse
extr.inv	<input type="checkbox"/> Extremely inverse
long inv	<input type="checkbox"/> long inverse
never	<input type="checkbox"/> Never
11 TEp	Trip time delay inverse time O/C stage IEp
min. 0.05	s
max. 3.20	_____
11 CHA e	Characteristic of the O/C stage IEp
inverse	<input type="checkbox"/> Inverse
short in	<input type="checkbox"/> Short inverse
long inv	<input type="checkbox"/> Long inverse
mode inv	<input type="checkbox"/> Moderately inverse
very inv	<input type="checkbox"/> Very inverse
extr inv	<input type="checkbox"/> Extremely inverse
def inv	<input type="checkbox"/> Definite inverse
IsquaredT	<input type="checkbox"/> I-squared-t
never	<input type="checkbox"/> Never
11 DE	Delayfactor of inverse earth-current protec.
min. 0.5	s
max. 15.0	_____
11 IEp	Pick-up value inverse time O/C stage IEp
min. 0.05	I/In
max. 4.00	_____
11IEpdy	Pick-up value inverse time E/F IEp (dyn)
min. 0.05	I/In
max. 4.00	_____
11CALC e	RMS format for inverse time O/C protection
noHARMON	<input type="checkbox"/> Without harmonics
HARMONIC	<input type="checkbox"/> With harmonics
11 M.CLe	Manual close
IE>>unde	<input type="checkbox"/> IE>> undelayed
IE>undel	<input type="checkbox"/> IE> undelayed
IEp unde	<input type="checkbox"/> IEp undelayed
INEFFECT	<input type="checkbox"/> Ineffective

24 UNBAL LOAD - UNBALANCED LOAD PROTECTION

24 UNB.L		State of the unbalanced load protection
ON	[]	on
OFF	[]	off
24 I2>		Pick-up value of neg. seq. I low-set stage I2>
min. 8		%
max. 80	_____	
24 TI2>		Trip delay of neg. seq. I low-set stage TI2>
min. 0.00		s
max. 60.00	_____	
24 I2>>		Pick-up value for high current stage
min. 8		%
max. 80	_____	
24 TI2>>		Trip time delay for high current stage
min. 0.00		s
max. 60.00	_____	

27 THERM OVERLOAD - THERMAL OVERLOAD PROTECTION

27 O/L		State of thermal overload protection
ON	[]	on
OFF	[]	off
27 k-FAC		K-factor for thermal overload protection
min. 0.40		
max. 2.00	_____	
27 τ -CON		Time constant for thermal overload protection
min. 1.0		min
max. 999.9	_____	
27 f- τ co		Multiplier of time constant at standstill
min. 1.00		
max. 10.00	_____	
27 Θ -ALM		Thermal warning stage
min. 50		%
max. 99	_____	
27 tL		Time-setting for I-squared-t overload stage
min. 1.0		s
max. 120.0	_____	
27 IL		Pick-up value for I-squared-t overload stage
min. 0.4		I/In
max. 4.0	_____	

28 START TIME SUP - STARTING-TIME SUPERVISION

28 STRT		Supervision of starting time
ON	[]	on
OFF	[]	off

28t strt		Max. permiss. starting time at I-START-MAX
min. 1.0		s
max. 360.0	_____	
28 Ia		Base value Istrt of permiss. start-up curr.
min. 0.4		I/In
max. 20.0	_____	
28I> blk		Block of the I>/Ip stages during start-up
NO	<input type="checkbox"/>	no
YES	<input type="checkbox"/>	yes

29 MEAS. VAL.SUP. - MEASURED VALUE SUPERVISION

29SUM.Th		Summation threshold for current monitoring
min. 0.05		I/In
max. 2.00/∞	_____	
29SUM.Fa		Factor for current summation monitoring
min. 0.00		
max. 0.95	_____	

34 AR - AUTO-RECLOSE FUNCTION

34 AR		Auto-reclose function
ON	<input type="checkbox"/>	on
OFF	<input type="checkbox"/>	off
34 ARcnt		Number of shots
min. 1		
max. 9	_____	
34 AR T1		Dead time for 1st shot
min. 0.05		s
max. 1800.00	_____	
34 AR T2		Dead time for 2nd shot
min. 0.05		s
max. 1800.00	_____	
34 AR T3		Dead time for 3rd shot
min. 0.05		s
max. 1800.00	_____	
34 AR T4		Dead time for 4th to 9th shot
min. 0.05		s
max. 1800.00	_____	
34 T-REC		Reclaim time after successful AR
min. 0.05		s
max. 320.00	_____	
34 T-LOC		Lock-out time after unsuccessful AR
min. 0.05		s
max. 320.00	_____	

34 T-BLM	Blocking duration with manual close
min. 0.50	s
max. 320.00	_____

37 CBCONTROL - CIRCUIT BREAKER CONTROLLING

37CB-Ctr	Circuit breaker controlling
ON	[] on
OFF	[] off

38 DELAY ANNUNC. - ANNUNCIATION DELAY TIMES

38T-Anc1	Delay time for 1st user defined annunciation
min. 0.00	s
max. 10.00	_____
38T-Anc2	Delay time for 2nd user defined annunciation
min. 0.00	s
max. 10.00	_____
38T-Anc3	Delay time for 3rd user defined annunciation
min. 0.00	s
max. 10.00	_____
38T-Anc4	Delay time for 4th user defined annunciation
min. 0.00	s
max. 10.00	_____

39CIRsup - TRIP CIRCUIT SUPERVISION

39CIRsup	Trip circuit supervision
ON	[] on
OFF	[] off

Reference Table for Configuration Parameters 7SJ602

60 MARSH - MARSHALLING

61 MARSH BIN.INP - MARSHALLING BINARY INPUTS

61 MARSH BI 1 - MARSHALLING OF BINARY INPUT 1

61BI1 1	BINARY INPUT 1 1st FUNCTION
_____	_____
61BI1 2	BINARY INPUT 1 2nd FUNCTION
_____	_____
61BI1 3	BINARY INPUT 1 3rd FUNCTION
_____	_____
61BI1 4	BINARY INPUT 1 4th FUNCTION
_____	_____
61BI1 5	BINARY INPUT 1 5th FUNCTION
_____	_____
61BI1 6	BINARY INPUT 1 6th FUNCTION
_____	_____
61BI1 7	BINARY INPUT 1 7th FUNCTION
_____	_____
61BI1 8	BINARY INPUT 1 8th FUNCTION
_____	_____
61BI1 9	BINARY INPUT 1 9th FUNCTION
_____	_____
61BI1 10	BINARY INPUT 1 10th FUNCTION
_____	_____

61 MARSH BI 2 - MARSHALLING OF BINARY INPUT 2

61BI2 1	BINARY INPUT 2 1st FUNCTION
_____	_____
61BI2 2	BINARY INPUT 2 2nd FUNCTION
_____	_____

61BI2 3	BINARY INPUT 2 3rd FUNCTION
_____	_____
61BI2 4	BINARY INPUT 2 4th FUNCTION
_____	_____
61BI2 5	BINARY INPUT 2 5th FUNCTION
_____	_____
61BI2 6	BINARY INPUT 2 6th FUNCTION
_____	_____
61BI2 7	BINARY INPUT 2 7th FUNCTION
_____	_____
61BI2 8	BINARY INPUT 2 8th FUNCTION
_____	_____
61BI2 9	BINARY INPUT 2 9th FUNCTION
_____	_____
61BI2 10	BINARY INPUT 2 10th FUNCTION
_____	_____

61 MARSH BI 3 - MARSHALLING OF BINARY INPUT 3

61BI3 1	BINARY INPUT 3 1st FUNCTION
_____	_____
61BI3 2	BINARY INPUT 3 2nd FUNCTION
_____	_____
61BI3 3	BINARY INPUT 3 3rd FUNCTION
_____	_____
61BI3 4	BINARY INPUT 3 4th FUNCTION
_____	_____
61BI3 5	BINARY INPUT 3 5th FUNCTION
_____	_____
61BI3 6	BINARY INPUT 3 6th FUNCTION
_____	_____

61BI3 7	BINARY INPUT 3 7th FUNCTION
_____	_____
61BI3 8	BINARY INPUT 3 8th FUNCTION
_____	_____
61BI3 9	BINARY INPUT 3 9th FUNCTION
_____	_____
61BI3 10	BINARY INPUT 3 10th FUNCTION
_____	_____

63 MARSH LED IND - MARSHALLING LED INDICATORS

63 MARSH LED 1 - MARSHALLING OF LED INDICATOR 1

63LED1 1	LED 1 1st CONDITION
_____	_____
63LED1 2	LED 1 2nd CONDITION
_____	_____
63LED1 3	LED 1 3rd CONDITION
_____	_____
63LED1 4	LED 1 4th CONDITION
_____	_____
63LED1 5	LED 1 5th CONDITION
_____	_____
63LED1 6	LED 1 6th CONDITION
_____	_____
63LED1 7	LED 1 7th CONDITION
_____	_____
63LED1 8	LED 1 8th CONDITION
_____	_____
63LED1 9	LED 1 9th CONDITION
_____	_____
63LED110	LED 1 10th CONDITION
_____	_____

63LED111	LED 1 11th CONDITION
----------	----------------------

63LED112	LED 1 12th CONDITION
----------	----------------------

63LED113	LED 1 13th CONDITION
----------	----------------------

63LED114	LED 1 14th CONDITION
----------	----------------------

63LED115	LED 1 15th CONDITION
----------	----------------------

63LED116	LED 1 16th CONDITION
----------	----------------------

63LED117	LED 1 17th CONDITION
----------	----------------------

63LED118	LED 1 18th CONDITION
----------	----------------------

63LED119	LED 1 19th CONDITION
----------	----------------------

63LED120	LED 1 20th CONDITION
----------	----------------------

63 MARSH LED 2 - MARSHALLING OF LED INDICATOR 2

63LED2 1	LED 2 1st CONDITION
----------	---------------------

63LED2 2	LED 2 2nd CONDITION
----------	---------------------

63LED2 3	LED 2 3rd CONDITION
----------	---------------------

63LED2 4	LED 2 4th CONDITION
----------	---------------------

63LED2 5	LED 2 5th CONDITION
----------	---------------------

63LED2 6	LED 2 6th CONDITION
----------	---------------------

63LED2 7	LED 2 7th CONDITION
----------	---------------------

63LED2 8	LED 2 8th CONDITION
----------	---------------------

63LED2 9	LED 2 9th CONDITION
----------	---------------------

63LED210	LED 2 10th CONDITION
----------	----------------------

63LED211	LED 2 11th CONDITION
----------	----------------------

63LED212	LED 2 12th CONDITION
----------	----------------------

63LED213	LED 2 13th CONDITION
----------	----------------------

63LED214	LED 2 14th CONDITION
----------	----------------------

63LED215	LED 2 15th CONDITION
----------	----------------------

63LED216	LED 2 16th CONDITION
----------	----------------------

63LED217	LED 2 17th CONDITION
----------	----------------------

63LED218	LED 2 18th CONDITION
----------	----------------------

63LED219	LED 2 19th CONDITION
----------	----------------------

63LED220	LED 2 20th CONDITION
----------	----------------------

63 MARSH LED 3 - MARSHALLING OF LED INDICATOR 3

63LED3 1	LED 3 1st CONDITION
----------	---------------------

63LED3 2	LED 3 2nd CONDITION
----------	---------------------

63LED3 3	LED 3 3rd CONDITION
----------	---------------------

63LED3 4	LED 3 4th CONDITION
----------	---------------------

63LED3 5	LED 3 5th CONDITION
----------	---------------------

63LED3 6	LED 3 6th CONDITION
----------	---------------------

63LED3 7	LED 3 7th CONDITION
----------	---------------------

63LED3 8	LED 3 8th CONDITION
----------	---------------------

63LED3 9	LED 3 9th CONDITION
----------	---------------------

63LED310	LED 3 10th CONDITION
----------	----------------------

63LED311	LED 3 11th CONDITION
----------	----------------------

63LED312	LED 3 12th CONDITION
----------	----------------------

63LED313	LED 3 13th CONDITION
----------	----------------------

63LED314	LED 3 14th CONDITION
_____	_____
63LED315	LED 3 15th CONDITION
_____	_____
63LED316	LED 3 16th CONDITION
_____	_____
63LED317	LED 3 17th CONDITION
_____	_____
63LED318	LED 3 18th CONDITION
_____	_____
63LED319	LED 3 19th CONDITION
_____	_____
63LED320	LED 3 20th CONDITION
_____	_____

63 MARSH LED 4 - MARSHALLING OF LED INDICATOR 4

63LED4 1	LED 4 1st CONDITION
_____	_____
63LED4 2	LED 4 2nd CONDITION
_____	_____
63LED4 3	LED 4 3rd CONDITION
_____	_____
63LED4 4	LED 4 4th CONDITION
_____	_____
63LED4 5	LED 4 5th CONDITION
_____	_____
63LED4 6	LED 4 6th CONDITION
_____	_____
63LED4 7	LED 4 7th CONDITION
_____	_____

63LED4 8	LED 4 8th CONDITION
_____	_____
63LED4 9	LED 4 9th CONDITION
_____	_____
63LED410	LED 4 10th CONDITION
_____	_____
63LED411	LED 4 11th CONDITION
_____	_____
63LED412	LED 4 12th CONDITION
_____	_____
63LED413	LED 4 13th CONDITION
_____	_____
63LED414	LED 4 14th CONDITION
_____	_____
63LED415	LED 4 15th CONDITION
_____	_____
63LED416	LED 4 16th CONDITION
_____	_____
63LED417	LED 4 17th CONDITION
_____	_____
63LED418	LED 4 18th CONDITION
_____	_____
63LED419	LED 4 19th CONDITION
_____	_____
63LED420	LED 4 20th CONDITION
_____	_____

64 MARSH CMD.REL - MARSHALLING TRIP RELAYS

64 MARSH CMD.RE 1 - MARSHALLING OF COMMAND RELAY 1

64CMD1 1	COMMAND RELAY 1 1st CONDITION
_____	_____

64CMD1 2	COMMAND RELAY 1 2nd CONDITION
_____	_____
64CMD1 3	COMMAND RELAY 1 3rd CONDITION
_____	_____
64CMD1 4	COMMAND RELAY 1 4th CONDITION
_____	_____
64CMD1 5	COMMAND RELAY 1 5th CONDITION
_____	_____
64CMD1 6	COMMAND RELAY 1 6th CONDITION
_____	_____
64CMD1 7	COMMAND RELAY 1 7th CONDITION
_____	_____
64CMD1 8	COMMAND RELAY 1 8th CONDITION
_____	_____
64CMD1 9	COMMAND RELAY 1 9th CONDITION
_____	_____
64CMD110	COMMAND RELAY 1 10th CONDITION
_____	_____
64CMD111	COMMAND RELAY 1 11th CONDITION
_____	_____
64CMD112	COMMAND RELAY 1 12th CONDITION
_____	_____
64CMD113	COMMAND RELAY 1 13th CONDITION
_____	_____
64CMD114	COMMAND RELAY 1 14th CONDITION
_____	_____
64CMD115	COMMAND RELAY 1 15th CONDITION
_____	_____
64CMD116	COMMAND RELAY 1 16th CONDITION
_____	_____

64CMD117	COMMAND RELAY 1 17th CONDITION
_____	_____
64CMD118	COMMAND RELAY 1 18th CONDITION
_____	_____
64CMD119	COMMAND RELAY 1 19th CONDITION
_____	_____
64CMD120	COMMAND RELAY 1 20th CONDITION
_____	_____

64 MARSH CMD.RE 2 - MARSHALLING OF COMMAND RELAY 2

64CMD2 1	COMMAND RELAY 2 1st CONDITION
_____	_____
64CMD2 2	COMMAND RELAY 2 2nd CONDITION
_____	_____
64CMD2 3	COMMAND RELAY 2 3rd CONDITION
_____	_____
64CMD2 4	COMMAND RELAY 2 4th CONDITION
_____	_____
64CMD2 5	COMMAND RELAY 2 5th CONDITION
_____	_____
64CMD2 6	COMMAND RELAY 2 6th CONDITION
_____	_____
64CMD2 7	COMMAND RELAY 2 7th CONDITION
_____	_____
64CMD2 8	COMMAND RELAY 2 8th CONDITION
_____	_____
64CMD2 9	COMMAND RELAY 2 9th CONDITION
_____	_____
64CMD210	COMMAND RELAY 2 10th CONDITION
_____	_____

64CMD211	COMMAND RELAY 2 11th CONDITION
----------	--------------------------------

64CMD212	COMMAND RELAY 2 12th CONDITION
----------	--------------------------------

64CMD213	COMMAND RELAY 2 13th CONDITION
----------	--------------------------------

64CMD214	COMMAND RELAY 2 14th CONDITION
----------	--------------------------------

64CMD215	COMMAND RELAY 2 15th CONDITION
----------	--------------------------------

64CMD216	COMMAND RELAY 2 16th CONDITION
----------	--------------------------------

64CMD217	COMMAND RELAY 2 17th CONDITION
----------	--------------------------------

64CMD218	COMMAND RELAY 2 18th CONDITION
----------	--------------------------------

64CMD219	COMMAND RELAY 2 19th CONDITION
----------	--------------------------------

64CMD220	COMMAND RELAY 2 20th CONDITION
----------	--------------------------------

64 MARSH CMD.RE 3 - MARSHALLING OF COMMAND RELAY 3

64CMD31	COMMAND RELAY 3 1st CONDITION
---------	-------------------------------

64CMD32	COMMAND RELAY 3 2nd CONDITION
---------	-------------------------------

64CMD33	COMMAND RELAY 3 3rd CONDITION
---------	-------------------------------

64CMD34	COMMAND RELAY 3 4th CONDITION
---------	-------------------------------

64CMD35	COMMAND RELAY 3 5th CONDITION
_____	_____
64CMD36	COMMAND RELAY 3 6th CONDITION
_____	_____
64CMD37	COMMAND RELAY 3 7th CONDITION
_____	_____
64CMD38	COMMAND RELAY 3 8th CONDITION
_____	_____
64CMD39	COMMAND RELAY 3 9th CONDITION
_____	_____
64CMD310	COMMAND RELAY 3 10th CONDITION
_____	_____
64CMD311	COMMAND RELAY 3 11th CONDITION
_____	_____
64CMD312	COMMAND RELAY 3 12th CONDITION
_____	_____
64CMD313	COMMAND RELAY 3 13th CONDITION
_____	_____
64CMD314	COMMAND RELAY 3 14th CONDITION
_____	_____
64CMD315	COMMAND RELAY 3 15th CONDITION
_____	_____
64CMD316	COMMAND RELAY 3 16th CONDITION
_____	_____
64CMD317	COMMAND RELAY 3 17th CONDITION
_____	_____
64CMD318	COMMAND RELAY 3 18th CONDITION
_____	_____
64CMD319	COMMAND RELAY 3 19th CONDITION
_____	_____

64CMD320	COMMAND RELAY 3 20th CONDITION
----------	--------------------------------

64 MARSH CMD.RE 4 - MARSHALLING OF COMMAND RELAY 4

64CMD41	COMMAND RELAY 4 1st CONDITION
---------	-------------------------------

64CMD42	COMMAND RELAY 4 2nd CONDITION
---------	-------------------------------

64CMD43	COMMAND RELAY 4 3rd CONDITION
---------	-------------------------------

64CMD44	COMMAND RELAY 4 4th CONDITION
---------	-------------------------------

64CMD45	COMMAND RELAY 4 5th CONDITION
---------	-------------------------------

64CMD46	COMMAND RELAY 4 6th CONDITION
---------	-------------------------------

64CMD47	COMMAND RELAY 4 7th CONDITION
---------	-------------------------------

64CMD48	COMMAND RELAY 4 8th CONDITION
---------	-------------------------------

64CMD49	COMMAND RELAY 4 9th CONDITION
---------	-------------------------------

64CMD410	COMMAND RELAY 4 10th CONDITION
----------	--------------------------------

64CMD411	COMMAND RELAY 4 11th CONDITION
----------	--------------------------------

64CMD412	COMMAND RELAY 4 12th CONDITION
----------	--------------------------------

64CMD413	COMMAND RELAY 4 13th CONDITION
----------	--------------------------------

64CMD414	COMMAND RELAY 4 14th CONDITION
_____	_____
64CMD415	COMMAND RELAY 4 15th CONDITION
_____	_____
64CMD416	COMMAND RELAY 4 16th CONDITION
_____	_____
64CMD417	COMMAND RELAY 4 17th CONDITION
_____	_____
64CMD418	COMMAND RELAY 4 18th CONDITION
_____	_____
64CMD419	COMMAND RELAY 4 19th CONDITION
_____	_____
64CMD420	COMMAND RELAY 4 20th CONDITION
_____	_____

65 AR MARSHALL - MARSHALLING OF AUTORECLOSE INPUTS

65AR MAR START - MARSHALLING OF AUTORECLOSE START

65 ARS01	AUTORECLOSE START 1st FUNCTION
_____	_____
65 ARS02	AUTORECLOSE START 2nd FUNCTION
_____	_____
65 ARS03	AUTORECLOSE START 3rd FUNCTION
_____	_____
65 ARS04	AUTORECLOSE START 4th FUNCTION
_____	_____
65 ARS05	AUTORECLOSE START 5th FUNCTION
_____	_____
65 ARS06	AUTORECLOSE START 6th FUNCTION
_____	_____
65 ARS07	AUTORECLOSE START 7th FUNCTION
_____	_____

65 ARS08	AUTORECLOSE START 8th FUNCTION
65 ARS09	AUTORECLOSE START 9th FUNCTION
65 ARS10	AUTORECLOSE START 10th FUNCTION
65 ARS11	AUTORECLOSE START 11th FUNCTION
65 ARS12	AUTORECLOSE START 12th FUNCTION
65 ARS13	AUTORECLOSE START 13th FUNCTION
65 ARS14	AUTORECLOSE START 14th FUNCTION
65 ARS15	AUTORECLOSE START 15th FUNCTION
65 ARS16	AUTORECLOSE START 16th FUNCTION
65 ARS17	AUTORECLOSE START 17th FUNCTION
65 ARS18	AUTORECLOSE START 18th FUNCTION
65 ARS19	AUTORECLOSE START 19th FUNCTION
65 ARS20	AUTORECLOSE START 20th FUNCTION

65AR MAR ST.BLOCK - MARSHALLING OF AUTORECLOSE BLOCK

65 ARB01	AUTORECLOSE BLOC. 1st FUNCTION
----------	--------------------------------

65 ARB02	AUTORECLOSE BLOC. 2nd FUNCTION
_____	_____
65 ARB03	AUTORECLOSE BLOC. 3rd FUNCTION
_____	_____
65 ARB04	AUTORECLOSE BLOC. 4th FUNCTION
_____	_____
65 ARB05	AUTORECLOSE BLOC. 5th FUNCTION
_____	_____
65 ARB06	AUTORECLOSE BLOC. 6th FUNCTION
_____	_____
65 ARB07	AUTORECLOSE BLOC. 7th FUNCTION
_____	_____
65 ARB08	AUTORECLOSE BLOC. 8th FUNCTION
_____	_____
65 ARB09	AUTORECLOSE BLOC. 9th FUNCTION
_____	_____
65 ARB10	AUTORECLOSE BLOC. 10th FUNCTION
_____	_____
65 ARB11	AUTORECLOSE BLOC. 11th FUNCTION
_____	_____
65 ARB12	AUTORECLOSE BLOC. 12th FUNCTION
_____	_____
65 ARB13	AUTORECLOSE BLOC. 13th FUNCTION
_____	_____
65 ARB14	AUTORECLOSE BLOC. 14th FUNCTION
_____	_____
65 ARB15	AUTORECLOSE BLOC. 15th FUNCTION
_____	_____
65 ARB16	AUTORECLOSE BLOC. 16th FUNCTION
_____	_____

65 ARB17	AUTORECLOSE BLOC. 17th FUNCTION
_____	_____
65 ARB18	AUTORECLOSE BLOC. 18th FUNCTION
_____	_____
65 ARB19	AUTORECLOSE BLOC. 19th FUNCTION
_____	_____
65 ARB20	AUTORECLOSE BLOC. 20th FUNCTION
_____	_____

65AR MAR CL.BLOCK - MARSHALLING OF AR COMMAND BLOCK

65 ARC01	AUTORECLOSE BLOC. COM. 1st FUNCTION
_____	_____
65 ARC02	AUTORECLOSE BLOC. COM. 2nd FUNCTION
_____	_____
65 ARC03	AUTORECLOSE BLOC. COM. 3rd FUNCTION
_____	_____
65 ARC04	AUTORECLOSE BLOC. COM. 4th FUNCTION
_____	_____
65 ARC05	AUTORECLOSE BLOC. COM. 5th FUNCTION
_____	_____
65 ARC06	AUTORECLOSE BLOC. COM. 6th FUNCTION
_____	_____
65 ARC07	AUTORECLOSE BLOC. COM. 7th FUNCTION
_____	_____
65 ARC08	AUTORECLOSE BLOC. COM. 8th FUNCTION
_____	_____
65 ARC09	AUTORECLOSE BLOC. COM. 9th FUNCTION
_____	_____
65 ARC10	AUTORECLOSE BLOC. COM. 10th FUNCTION
_____	_____

65 ARC11	AUTORECLOSE BLOC. COM. 11th FUNCTION
_____	_____
65 ARC12	AUTORECLOSE BLOC. COM. 12th FUNCTION
_____	_____
65 ARC13	AUTORECLOSE BLOC. COM. 13th FUNCTION
_____	_____
65 ARC14	AUTORECLOSE BLOC. COM. 14th FUNCTION
_____	_____
65 ARC15	AUTORECLOSE BLOC. COM. 15th FUNCTION
_____	_____
65 ARC16	AUTORECLOSE BLOC. COM. 16th FUNCTION
_____	_____
65 ARC17	AUTORECLOSE BLOC. COM. 17th FUNCTION
_____	_____
65 ARC18	AUTORECLOSE BLOC. COM. 18th FUNCTION
_____	_____
65 ARC19	AUTORECLOSE BLOC. COM. 19th FUNCTION
_____	_____
65 ARC20	AUTORECLOSE BLOC. COM. 20th FUNCTION
_____	_____

71INT.OP - INTEGRATED OPERATION

71LANGUA	Language
ENGLISH	[] English
DEUTSCH	[] German
FRANCAIS	[] French
ESPANOL	[] Spanish

72 INTER FACE - PC AND SYSTEM INTERFACES

72DEVICE	Device address
min. 1	
max. 254	_____
72FEEDER	Feeder address
min. 1	
max. 254	_____

72SUBSTA	Substation address	
min. 1		
max. 254	_____	
72F-TYPE	Function type in accord. with IEC60780-5-103	
min. 1		
max. 254	_____	
72PC-INT	Data format for PC-interface	
DIGSI V3	<input type="checkbox"/> DIGSI V3	
ASCII	<input type="checkbox"/> ASCII	
72 GAPS	Transmission gaps for PC-interface	
min. 0.0	s	
max. 5.0	_____	
72PCBAUD	Transmission baud rate for PC-interface	
9600BAUD	<input type="checkbox"/> 9600 Baud	
19200 BD	<input type="checkbox"/> 19200 Baud	
1200BAUD	<input type="checkbox"/> 1200 Baud	
2400BAUD	<input type="checkbox"/> 2400 Baud	
4800BAUD	<input type="checkbox"/> 4800 Baud	
72PARITY	Parity and stop-bits for PC-interface	
DIGSI V3	<input type="checkbox"/> DIGSI V3	
8O1	<input type="checkbox"/> Odd parity,1 stopbit	
8N2	<input type="checkbox"/> No parity,2 stopbits	
8N1	<input type="checkbox"/> No parity,1 stopbit	
72SYSINT	Data format for system-interface	
IEC com.	<input type="checkbox"/> IEC 60870 compatible	
IEC ext.	<input type="checkbox"/> IEC 60870 extended	
DIGSI V3	<input type="checkbox"/> DIGSI V3	
72S-MEAS	Measurement format for system-interface	
IEC com.	<input type="checkbox"/> IEC 60870 compatible	
IEC ext.	<input type="checkbox"/> IEC 60870 extended	
72S-GAPS	Transmission gaps for system-interface	
min. 0.0	s	
max. 5.0	_____	
72S-BAUD	Transmission baud rate for system-interface	
9600BAUD	<input type="checkbox"/> 9600 Baud	
19200 BD	<input type="checkbox"/> 19200 Baud	
1200BAUD	<input type="checkbox"/> 1200 Baud	
2400BAUD	<input type="checkbox"/> 2400 Baud	
4800BAUD	<input type="checkbox"/> 4800 Baud	
72S-PARI	Parity and stop-bits for system-interface	
IEC/DIGS	<input type="checkbox"/> IEC/DIGSI V3/LSA	
8O1	<input type="checkbox"/> Odd parity,1 stopbit	
8N2	<input type="checkbox"/> No parity,2 stopbits	
8N1	<input type="checkbox"/> No parity,1 stopbit	
72S-SWIT	Online-switch IEC - DIGSI enabled	
NO	<input type="checkbox"/> no	
YES	<input type="checkbox"/> yes	
72S-TOUT	Supervision time for system-interface	
min. 1	s	
max. 600/∞	_____	

72S-PARA		Parameterizing via system-interface
NO	<input type="checkbox"/>	no
YES	<input type="checkbox"/>	yes
72SW.REM		Switching authority REMOTE is
ON	<input type="checkbox"/>	on
OFF	<input type="checkbox"/>	off

74 FAULT RECORDER - FAULT RECORDINGS

74RECini		Initiation of data storage
RECbyFT	<input type="checkbox"/>	Storage by fault det
RECbyTP	<input type="checkbox"/>	Storage by trip
SRTwitTP	<input type="checkbox"/>	Start with trip
74 T-MAX		Maximum time period of a fault recording
min. 0.30		s
max. 5.00	_____	
74 T-PRE		Pre-trigger time for fault recording
min. 0.05		s
max. 0.50	_____	
74 T-POS		Post-fault time for fault recording
min. 0.05		s
max. 0.50	_____	

95 SYST SETTING - OPERATING SYSTEM SETTINGS

95 TEST		Activating internal test
NONE	<input type="checkbox"/>	none
withREPO	<input type="checkbox"/>	With report
BUF-OVFL	<input type="checkbox"/>	Err.buf.owerfl=moni
95 MODUL		Number of tested module
min. 0		
max. 100	_____	
95S-BLOC		Blocking of monitoring direction via sys.-int.
OFF	<input type="checkbox"/>	off
ON	<input type="checkbox"/>	on

To

SIEMENS AKTIENGESELLSCHAFT

Dept. EV S SUP 21

D-13623 BERLIN

Germany

Dear reader,

printing errors can never be entirely eliminated: therefore, should you come across any when reading this manual, kindly enter them in this form together with any comments or suggestions for improvement that you may have.

From_____
Name_____
Company/Dept._____
Address_____
Telephone no.
_____**Corrections/Suggestions**

Subject to technical alteration

Siemens Aktiengesellschaft

Copying of this document and giving it to others and the use or communication of the contents thereof, are forbidden without express authority. Offenders are liable to the payment of damages. All rights are reserved in the event of the grant of a patent or the registration of a utility model or design.

Order No. C53000–G1176–C125–1
Available from: LZF Fürth–Bislohe
Printed in the Federal Republic of Germany
AG 1299 0.5 FO 198 En